



# ELECRRAFT® P3

## HIGH-PERFORMANCE PANADAPTER

### OWNER'S MANUAL

Revision F, January 11, 2016

E740152

Copyright © 2016, Elecraft, Inc.

All Rights Reserved

# Contents

**NOTE: IF YOU PURCHASED YOUR P3 AS A KIT, GO DIRECTLY TO *KIT ASSEMBLY INSTRUCTIONS* ON PAGE 47 TO ASSEMBLE YOUR P3.**

Key to Symbols and Text Styles.....	2	Transmit Monitor (TX Mon) Option .....	28
Quick-Start Guide .....	3	Firmware Upgrades.....	31
Introduction.....	6	Checking your Firmware Revision.....	31
P3 Features .....	6	P3 Firmware Self-Test.....	31
P3SVGA Option.....	6	Forcing a Firmware Download.....	31
Transmit Monitor (Tx Mon) Option.....	7	Updating K3 Firmware .....	31
Specifications .....	7	Configuration .....	31
Customer Service and Support.....	8	Calibration Procedures.....	33
Front Panel.....	9	Calibration Procedures.....	33
Control Groups.....	9	Frequency Calibration .....	33
Display .....	10	Amplitude Calibration .....	33
Primary Controls .....	10	Amplitude Calibration for Transverters.....	34
Menu .....	11	Transmit Monitor (Tx Mon) Calibration .....	34
Programmable Function Keys.....	11	Menu Functions .....	35
Rear Panel Connectors.....	12	Basic P3 Menu.....	35
Basic Operation .....	13	P3SVGA Option Menu.....	37
Using Tap/Hold Switches .....	13	Transmit Monitor Menu .....	38
Initial Power-Up.....	13	Troubleshooting .....	38
Configuring the Display .....	13	Parameter Initialization.....	39
Using the Menu.....	13	Theory of Operation.....	39
Programmable Functions .....	14	Parts List .....	41
Adjusting the Frequencies Displayed.....	14	P3 Sheet Metal Box - E850435 .....	41
Using Markers.....	15	P3 Misc Bag - E850433.....	42
Waterfall Markers .....	15	P3 PCB Box – E850436 .....	44
Using Cursors.....	15	P3SVGA Parts .....	45
Noise Blanker.....	16	Transmit Monitor (Tx Mon) Parts .....	46
How to Set Up and Interpret the P3 Display .	17	Kit Assembly Instructions .....	47
Spectrum Display .....	17	Preventing Electrostatic Discharge Damage.....	47
Waterfall Display .....	18	Tools Required .....	48
Averaging and Peak Hold .....	18	Assembly Procedure .....	48
Span.....	18	Servicing the P3 .....	65
Fixed-tune mode.....	18	Accessing the PC Boards.....	65
Typical Spectra.....	19	Cleaning the LCD Bezel.....	65
Advanced Operating Features.....	21	Replacing the LCD Display .....	66
Basic P3.....	21		
P3SVGA Option.....	22		

 Elecraft manuals with color images may be downloaded from [www.elecraft.com](http://www.elecraft.com).

# Key to Symbols and Text Styles



**Important – read carefully**



Operating tip

**-100**

Characters displayed on the LCD screen

**DISPLAY**

**Tap** switch function (labeled *above* a switch)

**AVERAGE**

**Hold** switch function (labeled *below* a switch; hold for 1/2 sec. to activate)

⌚ **SELECT**

Rotary control

⌚ **QSY**

**Tap** switch function of rotary control (labeled *above* the knob)

⌚ **UNDO QSY**

**Hold** switch function of rotary control (hold for 1/2 sec.)

*MENU:Font*

Typical menu entry

# Quick-Start Guide

To get started using your P3 right away, please read this page and the two pages that follow, trying each of the controls.

**⚠ The first thing you need to know about the P3** is that most switches have two functions. **Tap** (*press briefly*) to activate the function labeled **above** a switch. **Hold** activates the function labeled **below** the switch. In the text, tap functions are shown like this: **DISPLAY**. An example of a hold function is **AVERAGE**. Additional typographical conventions are shown on the previous page.

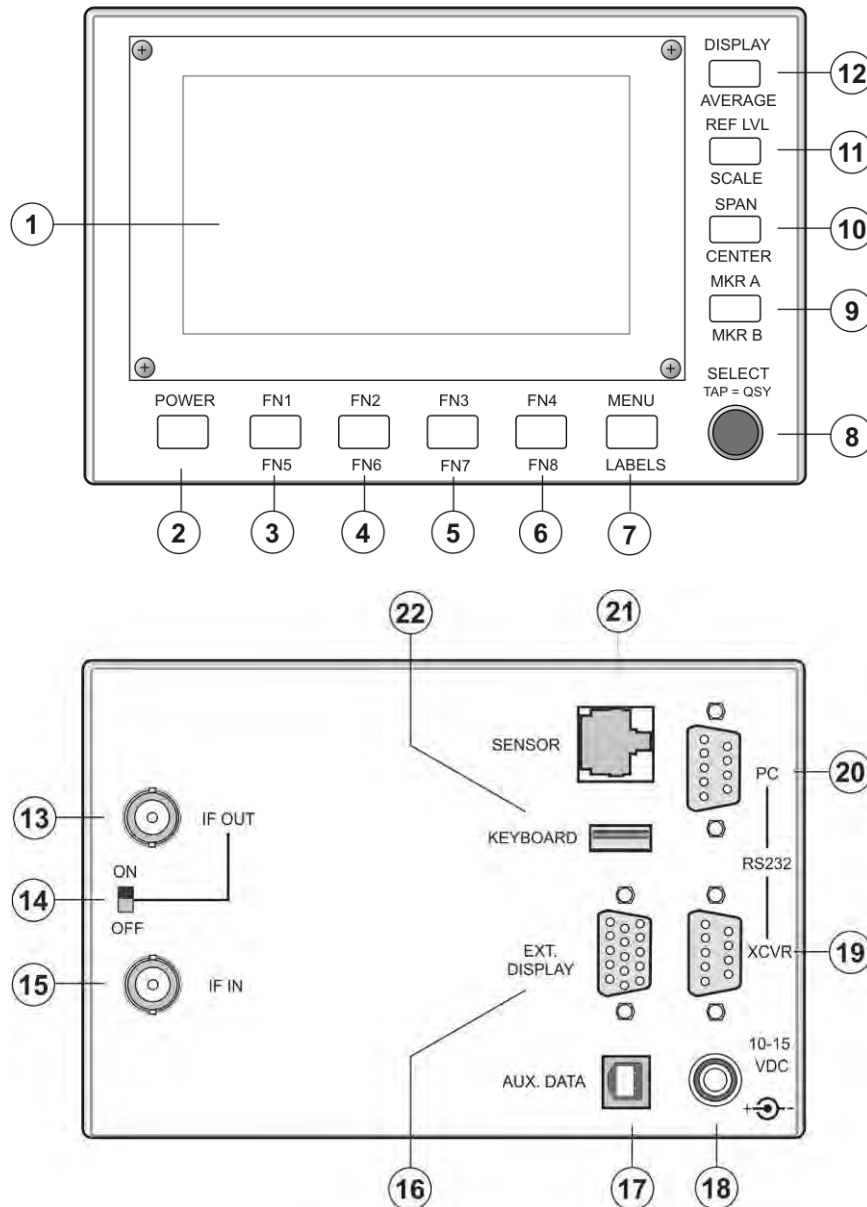

## ⚠ IMPORTANT

K3's built before September 2009 should have the I.F. Buffer Gain Modification installed for best weak-signal display on the P3. This modification changes a single resistor to increase the I.F. output from the K3 by about 10 dB. A modification kit consisting of the resistor and installation instructions is included with your P3.

*This modification is not required for K3 RF boards version H3 and later.*

<p><b>Connections</b></p> 	<ul style="list-style-type: none"><li>• Make the basic cable connections to your P3 as shown on page 5 if:<ul style="list-style-type: none"><li>▪ you have a K3S or a K3 with the KIO3B upgrade installed, and</li><li>▪ your personal computer has a USB port.</li></ul></li><li>• Make the basic cable connections shown on page 6 if you have a K3S or a K3 and need an RS-232 interface to your computer.</li><li>• Make the basic cable connections shown on page 7 if you have a K3 without the KIO3B interface. <b>⚠</b> If your K3 does not have the KIO3B interface you will find two DB connectors marked RS232 and ACC on the rear panel as shown in the rear-panel view of the K3 on page 7.</li><li>• If you have the P3SVGA option installed in your P3, connect your monitor and keyboard as shown on page 8.</li><li>• If you have the Transmit Monitor option installed in your P3, connect the sensor and antenna cables as shown on page 29.</li></ul>
<p><b>The Basics</b></p>	<ul style="list-style-type: none"><li>• Turn on the power supply that is supplying the P3. If power is obtained from the 12VDC OUT jack of a K3, turn on the K3. If necessary, press <b>POWER</b> (2) to turn on the P3. You can position a jumper to have the P3 turn on automatically with the K3 (see <i>Configuration</i> on page 31).</li><li>• <b>TAP</b> and <b>HOLD</b> Functions: <b>Tapping</b> briefly activates the function labeled in white <i>above</i> a switch. <b>Holding</b> for about 1/2 second activates the function labeled in yellow <i>below</i> a switch. Try tapping <b>MENU</b> (7) to bring up the main menu. Rotate <b>SELECT</b> (8) knob to scroll through the menu entries. Tapping the knob selects the entry currently displayed. Tap the knob again to deselect the entry. Tap <b>MENU</b> (7) to exit the menu.</li><li>• Tap <b>DISPLAY</b> (12) to cycle between spectrum and waterfall display modes (Page 13).</li><li>• Activating many functions enables the <b>SELECT</b> (8) knob so you can adjust the parameter associated with the function. The current parameter value is shown on the screen (1). You can exit and save the parameter by tapping the same key a second time, even for hold functions.</li><li>• For hold functions, you can also hold the key a second time to exit parameter-entry mode. In the case of the hold functions associated with the four keys along the right edge of the front panel (9)-(12), holding the key a second time also de-activates the function itself. For example, holding <b>CENTER</b> a second time returns the display center frequency to the transceiver frequency and holding <b>(MKR B)</b> a second time turns off marker B.</li><li>• For best frequency accuracy, especially when using narrow spans, perform the frequency calibration procedure described on page 32.</li></ul>

**UNLESS OTHERWISE NOTED, CABLES ARE SUPPLIED WITH THE P3**

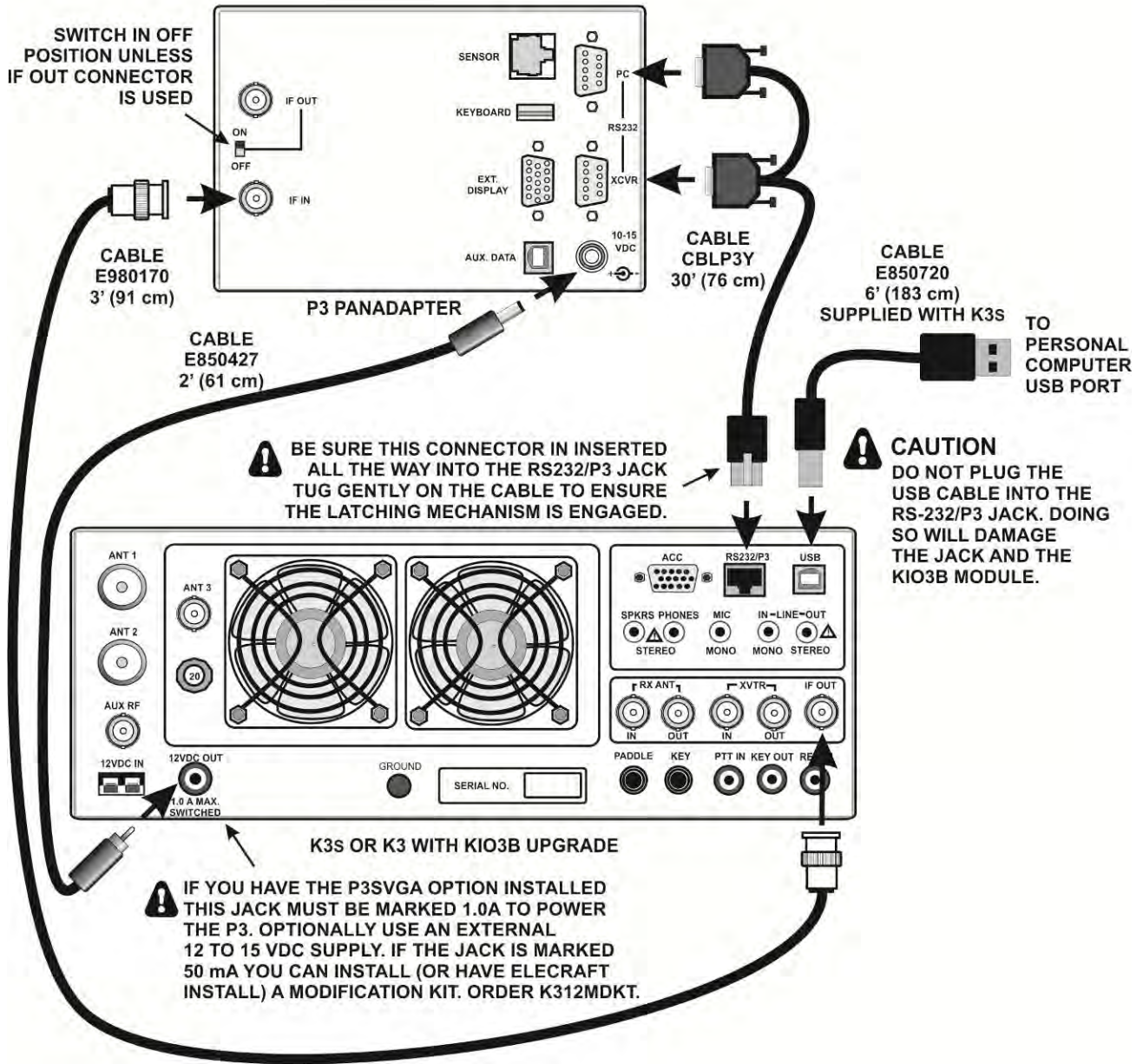

**Basic K3s/P3 Cabling for USB Interface to a Personal Computer.**

**⚠ UNLESS OTHERWISE NOTED, CABLES ARE SUPPLIED WITH THE P3**

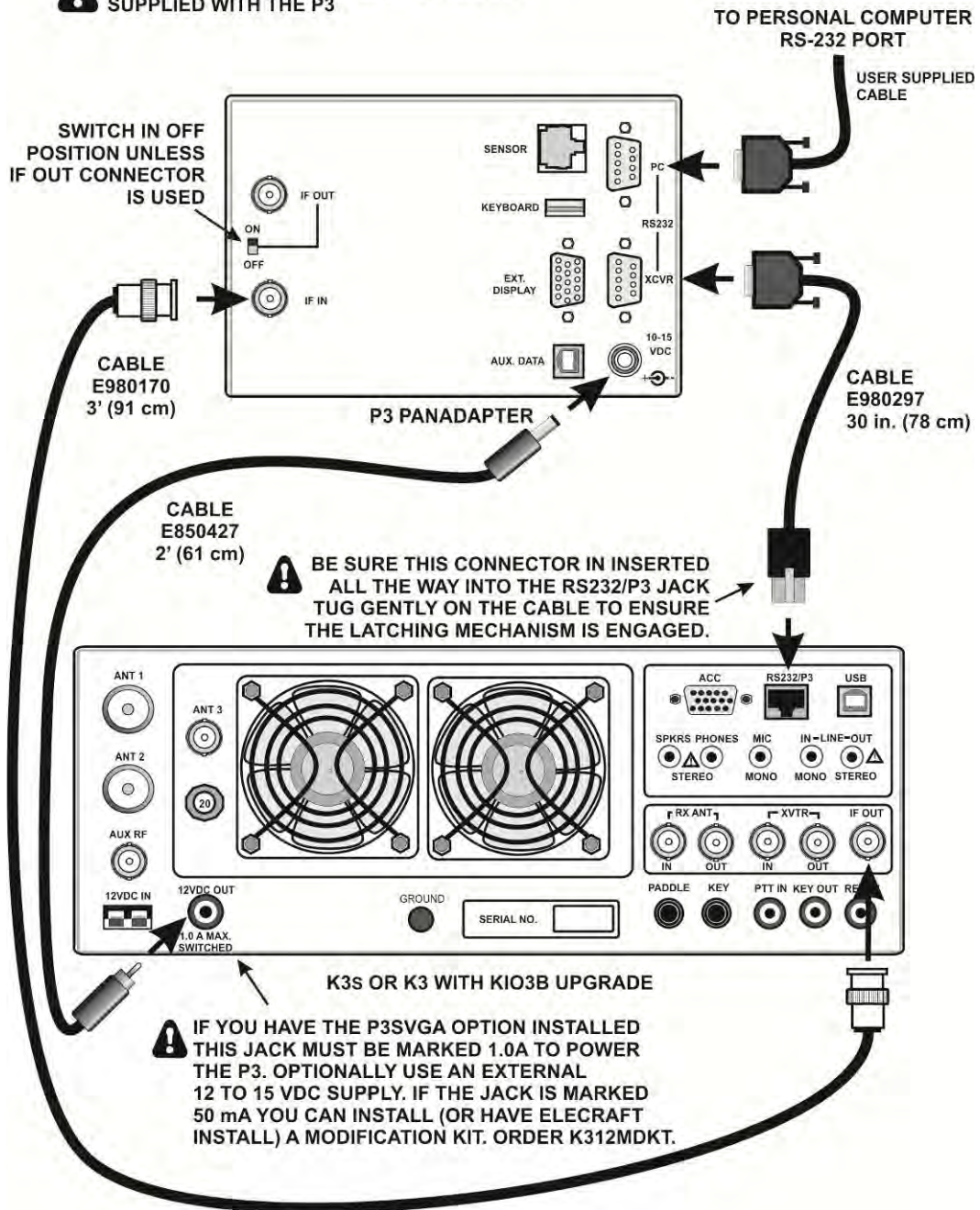

**Basic K3s/P3 Cabling for RS232 Interface to a Personal Computer.**

**⚠ UNLESS OTHERWISE NOTED, CABLES ARE SUPPLIED WITH THE P3**

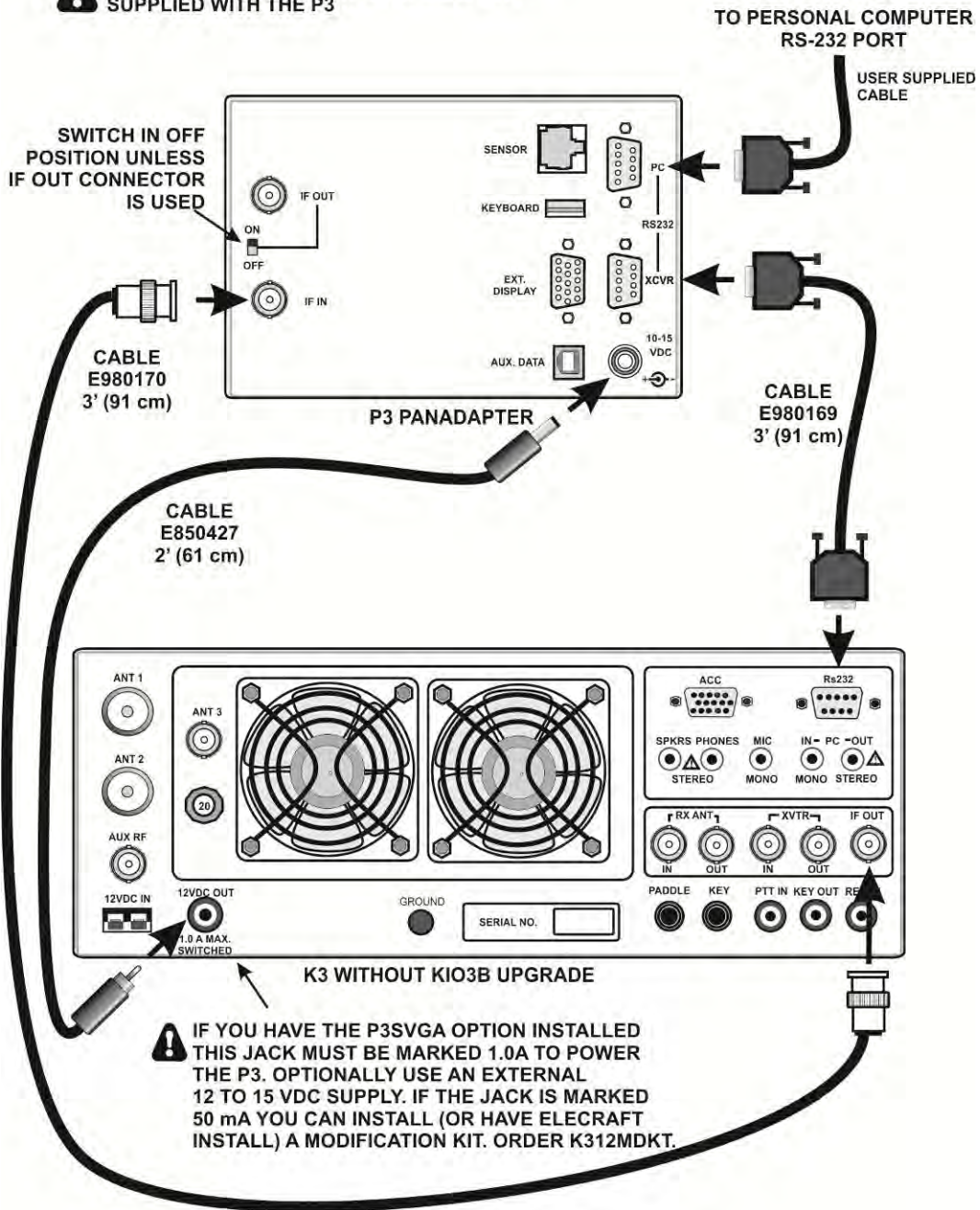

**Basic K3/P3 Cabling for RS232 Interface to a Personal Computer.**



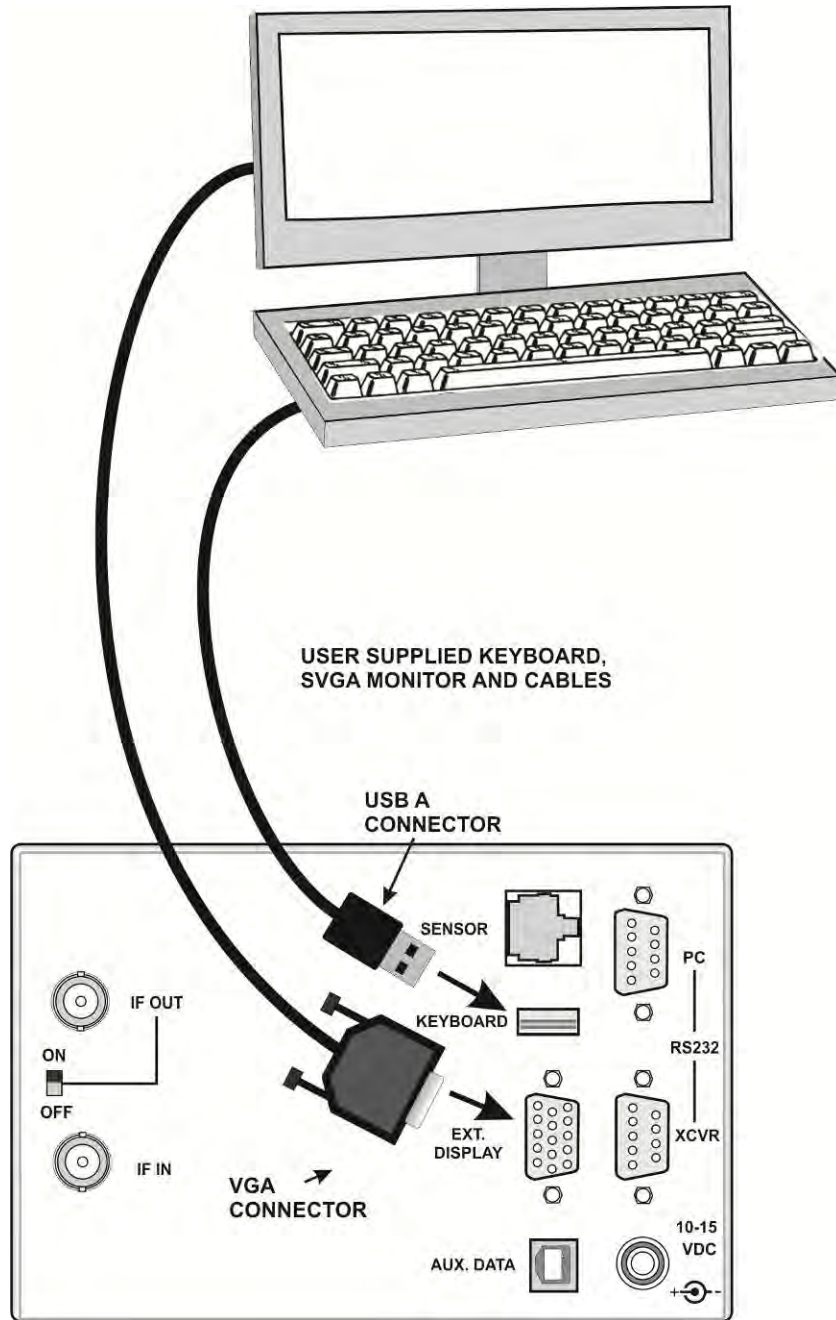

**Additional Cabling for Optional Keyboard and Monitor if P3SVGA Installed.**

## Other Features

- Hold **LABELS** (7) to toggle on or off the function key labels located at the bottom of the screen, just above the function keys (Pages 10 and 11).
- Tap **MENU** (7) and use the **SELECT** knob (8) to scroll through the list. You can tap or hold one of the function keys {3-6} to assign the currently-displayed function to the key. If the function key labels are on, the label for that key will change to show the selected function (see page 10).
- Tapping the **SELECT** knob (8) while the menu is active causes the currently-selected menu function to execute. Select *LCD Brt* from the menu and tap the knob. The knob now adjusts the brightness of the LCD display backlight. Tap the knob again to exit the selection or tap **MENU** (7) to select a different menu item. Some menu items are toggle functions. Instead of changing the parameter by turning the **SELECT** knob, it changes automatically whenever the knob is tapped. The new value is displayed briefly near the top of the spectrum display. Menu items are listed on page 35.
- Tap **MKR A** (9) or hold **MKR B** (9) to turn on marker A or B. Rotate the **SELECT** knob to place the selected marker at a desired frequency on the display. Markers may be used to measure the frequency of an interesting signal and, if the transceiver is a K3, tapping the knob will QSY (change the frequency of) the K3 to that frequency. **MKR A** controls the K3's VFO A and **MKR B** controls VFO B. The marker colors match the corresponding VFO cursors to emphasize the correspondence. Whichever marker is currently selected is the one that causes the K3 to QSY (see page 10).
- To return from the last QSY ("undo" function), *hold* the **SELECT** knob pushbutton. To turn off marker A, tap **MKR A** (9) while marker A is selected. To turn off marker B, hold **MKR B** (9) while marker B is selected.
- Tap **SPAN** (10) to set the frequency span of the display. The start frequency is displayed at the top left of the spectrum window and the stop frequency is displayed at the top right of the spectrum window (see page 10).
- Hold **CENTER** (10) to set the center frequency of the display (Page 11). This function may be disabled when in tracking mode via the *MENU:CenterEn* function.
- Tap **REF LVL** (11) to set the amplitude reference level of the display, both spectrum and waterfall. The term "reference level" means the signal level that corresponds to the bottom of the spectrum display (see page 11).
- Hold **SCALE** (11) to set the scale, or range, of both the spectrum and waterfall displays. For example, 60 dB means that the bottom of the display is 60 dB below the top (see page 11).
- Hold **AVERAGE** (12) to turn on display averaging and allow adjustment of the averaging time (see page 11).

# Introduction

This comprehensive manual covers all the features and capabilities of the Elecraft P3 panoramic display. We recommend that you begin with the **Quick-Start Guide** (page. 3). The **Front Panel** (page. 9) and **Rear Panel** (page. 12) sections are for general reference. **Basic Operation** (page. 12) and **Advanced Operation** (page. 16) fill in the details of the full capabilities of the P3.

This manual assumes that your P3 is equipped with firmware version 1.29 and, if equipped, SVGA 1.16 (See *Checking your Firmware Version* on page 31).

## P3 Features

The P3 offers a number of advanced features to enhance performance and versatility:

### *Compatible Receivers/Transceivers*

- May be used with any receiver having an I.F. output between 455 kHz and 21.7 MHz (including the Elecraft K2 with suitable modification). The P3 is usable with frequencies as low as 300 kHz.
- Integrates very closely with the Elecraft K3 with point-and-click QSY and an “undo” feature with simple control press to return to the previous frequency.

### *Easy Set-Up*

- Only two cables for basic operation (I.F. and power).
- Optional additional connections provided for transceiver communications, a personal computer and optional accessories.
- No configuration or calibration is required.

### *Display*

- Bright, high-resolution, full color display.
- Efficient LED backlight for long life and low power consumption.
- Both fixed-tune and transceiver-tracking modes for the display frequency.
- Both Spectrum and Waterfall displays.
- Fast display update.
- Up to 200 kHz span.
- Frequency resolution automatically increases as span is decreased.
- Excellent sensitivity and dynamic range.

### *Ergonomic Design*

- Uncluttered interface.
- No unused controls on the screen.

### *Field Upgradable*

- Software defined architecture so many new features will require only a simple firmware update using the provided PC utility program.
- Room inside for future hardware updates.

## P3SVGA Option

The P3SVGA Super Video Graphics Array option adds wide screen display capability to the P3 with enhanced data terminal operations that permits sending text from a keyboard attached to the P3, storing messages in memory that may be recalled with a simple keystroke, and transmitting a stored message at regular intervals. The P3SVGA features a dedicated, high-speed Fast Fourier Transform (FFT) processor that performs a 2048 point FFT in parallel with the P3’s existing processor for a much higher frequency resolution per dot on the larger screen. The P3SVGA includes a USB connector that can accept a flash memory drive for screen dumps and connect to many USB keyboards to allow direct digital mode operation via the K3 and P3 with transmit and receive display on an external monitor.

The P3SVGA adds three connectors to the P3 rear panel: KEYBOARD, EXT. DISPLAY and AUX DATA. Only the KEYBOARD and EXT. DISPLAY connectors are active at this time. The AUX DATA connector is reserved for future use.

The P3SVGA supports the following video resolutions:

1024 X 768  
1280 X 1024  
1440 X 900  
1920 X 1080

Note that 1440 x 900 will display correctly on 1920 x 1080 monitors.

## Transmit Monitor (Tx Mon) Option

The P3 transmit monitor displays the RF power and modulation waveform of a transmitter as well as the SWR of the antenna and feed line. You can measure either the transmitter or a power amplifier by placing an appropriate sensor module at the output of the device to be measured.

Peak power and SWR are displayed both on analog meter-like displays as well as digital readouts. The modulation display has an optional split screen for CW mode to show the waveform rise and fall simultaneously.

Like the P3 itself, the transmit monitor can be used with any transceiver. The sensor unit detects the presence of RF power and switches to the transmit display you have selected without any other control signals from the transmitter. If desired you can disable the modulation envelope monitoring and still monitor the RF power and SWR on the P3. Sensors are available covering the following frequencies and power levels:

- 1.8 MHz through 54 MHz at power levels up to 200 W.
- 1.8 MHz through 54 MHz at up to 2 kW.
- 144 MHz through 450 MHz at up to 200 watts.

## Specifications

<b>I.F. Frequency Range:</b>	455 kHz to 21.7 MHz (usable with frequencies as low as 300 kHz)
<b>Noise Figure:</b>	< 10 dB measured at P3 input typical
<b>Blocking Dynamic Range:</b>	> 120 dB (500 Hz bandwidth) typical
<b>Absolute Level Accuracy:</b>	± 3 dB plus display resolution after calibration at S9 (-73 dBm)
<b>Relative Level Accuracy:</b>	± 0.1 dB plus display resolution
<b>Display Update Rate:</b>	Selectable 1 Hz to 20 Hz (slower at narrowest spans)
<b>Amplitude Scale:</b>	10 dB minimum, 80 dB maximum
<b>Span:</b>	2 kHz minimum, 200 kHz maximum
<b>Resolution Bandwidth:</b>	Span / 450, 8 Hz minimum
<b>Power Requirements:</b>	10 to 15 VDC, 0.5 A maximum without the P3SVGA option; 0.7 A with the P3SVGA option enabled.
<b>Weight:</b>	5.5 lbs (2.5 kg)
<b>Size:</b>	Enclosure only, 4.0 x 6.1 x 10.0 in., HWD (10.2 x 15.6 x 25.4 cm). With projections, 4.4 x 6.1 x 11.8 in. (11.2 x 15.6 x 30.0 cm).

## Customer Service and Support

### *Technical Assistance*

You can send e-mail to [k3support@elecraft.com](mailto:k3support@elecraft.com) and we will respond quickly – typically the same day Monday through Friday. If you need replacement parts, send an e-mail to [parts@elecraft.com](mailto:parts@elecraft.com). Telephone assistance is available from 9 A.M. to 5 P.M. Pacific time (weekdays only) at 831-763-4211. Please use e-mail rather than calling when possible since this gives us a written record of the details of your problem and allows us to handle a larger number of requests each day.

### *Repair / Alignment Service*

If necessary, you may return your Elecraft product to us for repair or alignment. (Note: We offer unlimited email and phone support, so please try that route first as we can usually help you find the problem quickly.)

**IMPORTANT: You must contact Elecraft before mailing your product** to obtain authorization for the return, what address to ship it to and current information on repair fees and turnaround times. (Frequently we can determine the cause of your problem and save you the trouble of shipping it back to us.) Our repair location is different from our factory location in Aptos. We will give you the address to ship your kit to at the time of repair authorization. *Packages shipped to Aptos without authorization will incur an additional shipping charge for reshipment from Aptos to our repair depot.*

### **Elecraft 1-Year Limited Warranty**

This warranty is effective as of the date of first consumer purchase (or if shipped from the factory, the date the product is shipped to the customer). It covers both our kits and fully assembled products. For kits, before requesting warranty service, you should fully complete the assembly, carefully following all instructions in the manual.

**Who is covered:** This warranty covers the original owner of the Elecraft product as disclosed to Elecraft at the time of order. Elecraft products transferred by the purchaser to a third party, either by sale, gift, or other method, who is not disclosed to Elecraft at the time of original order, are not covered by this warranty. If the Elecraft product is being bought indirectly for a third party, the third party's name and address must be provided at time of order to ensure warranty coverage.

**What is covered:** During the first year after date of purchase, Elecraft will replace defective or missing parts free of charge (post-paid). We will also correct any malfunction to kits or assembled units caused by defective parts and materials. Purchaser pays inbound shipping to us for warranty repair; we pay shipping to return the repaired equipment to you by UPS ground service or equivalent to the continental USA and Canada. For Alaska, Hawaii, and other destinations outside the U.S. and Canada, actual return shipping cost is paid by the owner.

**What is not covered:** This warranty does not cover correction of kit assembly errors. It also does not cover misalignment; repair of damage caused by misuse, negligence, or builder modifications; or any performance malfunctions involving non-Elecraft accessory equipment. The use of acid-core solder, water-soluble flux solder, or any corrosive or conductive flux or solvent will void this warranty in its entirety. Also not covered is reimbursement for loss of use, inconvenience, customer assembly or alignment time, or cost of unauthorized service.

**Limitation of incidental or consequential damages:** This warranty does not extend to non-Elecraft equipment or components used in conjunction with our products. Any such repair or replacement is the responsibility of the customer. Elecraft will not be liable for any special, indirect, incidental or consequential damages, including but not limited to any loss of business or profits.

# Front Panel

This section describes all front panel controls and the liquid crystal display (LCD). Operating instructions are covered in later sections.

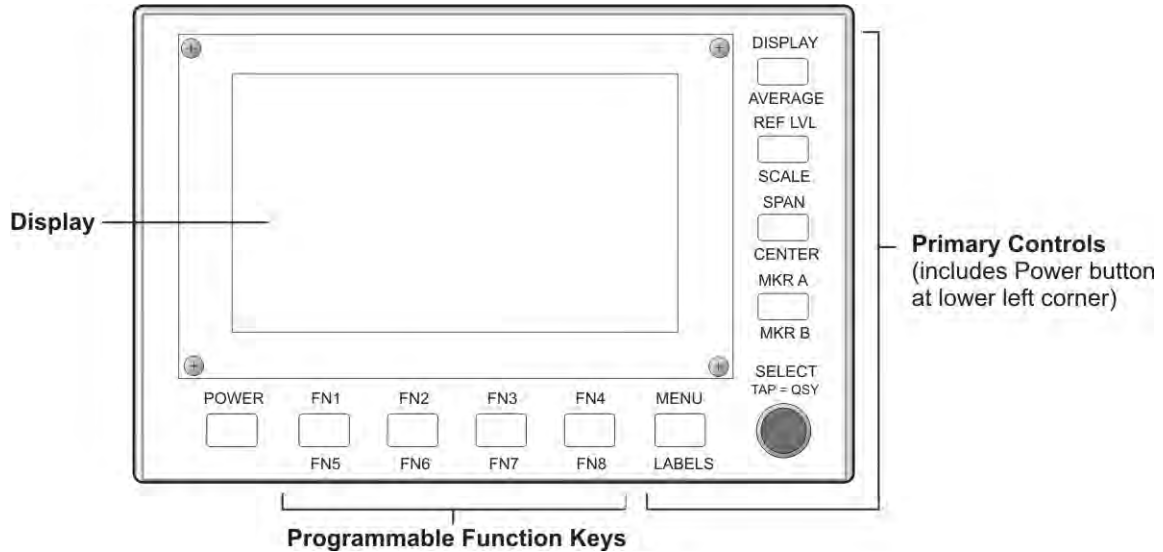

## Control Groups

**Primary controls (page 10):** These keys are hard-coded with permanent function assignments. They provide the most important operational features needed for basic panadapter operation, including display options, amplitude scaling, frequency control and markers.

**Programmable function keys (page 11):** The function keys may be assigned to any of the functions in the **MENU** list. These include less-used operational features, test functions, and setup and calibration routines.

## Display

The 480x272-pixel, color TFT-LCD display is used both for the panadapter spectrum and waterfall graphics as well as for general-purpose information needed by the operator. All graphics and text are

bit-mapped and so are software-defined. The backlight brightness and the text size can be changed via a **MENU** entry (see page 35).

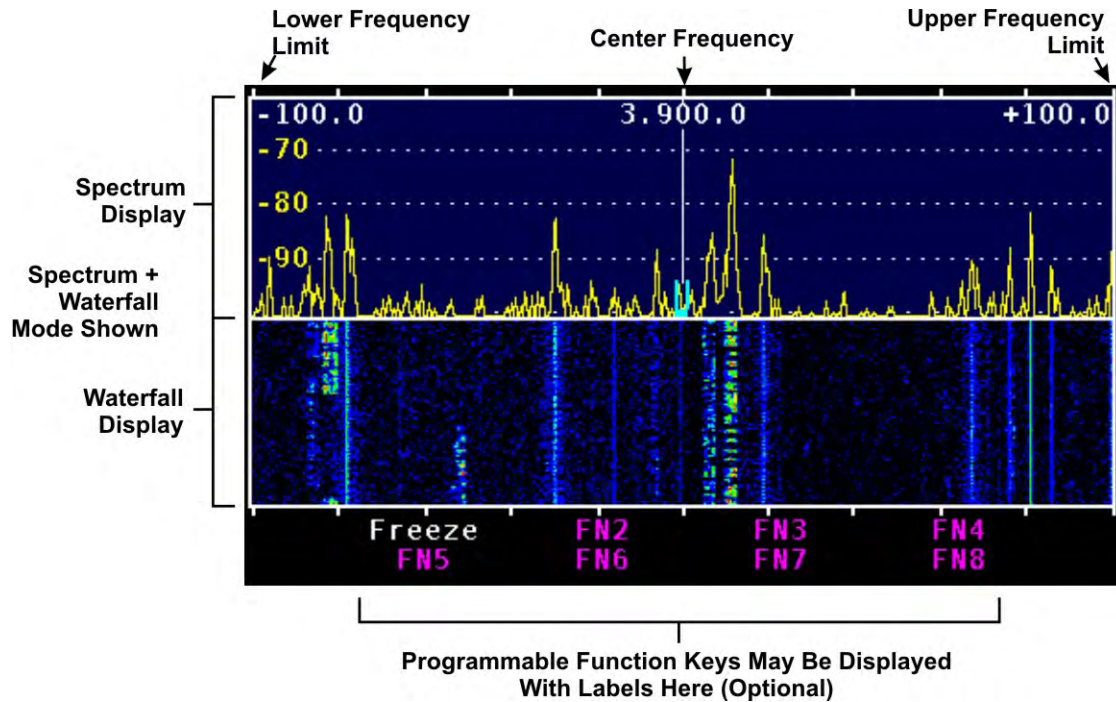

## Primary Controls

**POWER** Turns the P3 on or off. The P3 may be configured to turn on automatically whenever power is applied, such as when it is powered from a K3 transceiver, by moving a jumper on the rear-panel I/O board (see *Configuration* on page 31 for details.) Holding the **POWER** switch for more than 10 seconds places the P3 in boot-load mode, ready to receive new firmware via the RS232 PC connector. If you do this accidentally, simply cycle the **POWER** switch to restore normal operation.

**MKR A** and **MKR B** Selecting one of these functions causes a marker to appear on the display, using different colors for A and B. The marker frequency can be adjusted by turning the **SELECT** knob. If the transceiver is a K3 and it is connected to the P3 via RS232, then tapping the knob changes the frequency of (QSY) the K3 to that frequency. **MKR A** controls the K3's VFO A and **MKR B** controls VFO B. The marker colors match the corresponding VFO cursors to emphasize the

correspondence. Whichever marker is currently selected is the one that causes the K3 to QSY. To return from the last QSY ("undo" function), *hold* the **SELECT** knob pushbutton.

To turn off **MKR A**, *tap* the key while marker A is selected. To turn off **MKR B**, *hold* the key while marker B is selected. When a marker is turned back on after having been turned off, it will come back at the same frequency unless it is off-screen, in which case the marker defaults to the center frequency.

When another function that uses the **SELECT** knob is activated, the marker(s) stay visible and when that other function is de-selected the last active marker automatically becomes active again.

**SPAN** Sets the frequency span of the display. The available range is 2 kHz to 200 kHz. The start and stop frequencies are displayed at the top (left and right edge respectively) of the spectrum window.

**CENTER** sets the center frequency of the display, which is also displayed at the top center of the spectrum window when in tracking mode. If *MENU:CenterEn* is set to OFF, then this function is disabled for tracking mode. If the transceiver is a K3, the center frequency defaults to the VFO A frequency of the K3, but it may be tuned above and below that value. It will then track any changes in the K3's VFO A.

In fixed-tune mode as well, **CENTER** sets the center frequency of the display, however it does not track the K3 VFO but stays at a fixed frequency. If desired, you can set the center frequency to re-adjust automatically by setting the proper mode in *MENU:FixMode*. In both fixed and tracking modes, hold the **CENTER** key a second time to return the center frequency to the K3's VFO A frequency.

**REF LVL** Sets the amplitude reference level of the display, both spectrum and waterfall. The term "reference level" means the signal level that corresponds to the bottom of the spectrum display and the minimum signal level (dark blue) of the waterfall. The amplitude labels that appear along the left edge of the spectrum display may be in dBm or S-units plus dB over S9, depending on the setting of *MENU:Lvl Mode*. If the transceiver is a K3, the amplitude is that of the signal at the K3 antenna input, with the state of the K3's attenuator and preamp taken into account. Tap any key to de-select the parameter entry.

**SCALE** Sets the scale, or range, of both the spectrum and waterfall displays. For example, "60 dB" means that the bottom of the display is 60 dB below the top. Tap any key to de-select the parameter entry.

**DISPLAY** Toggles between the spectrum, and combination spectrum/waterfall display modes.

**AVERAGE** Turns on display averaging and allows adjustment of the averaging time, in units of the display update period. To de-select parameter entry and turn off averaging at the same time, *hold* the key a second time. To de-select parameter entry while leaving averaging turned on, *tap* the key.

## Menu

**MENU** Accesses an alphabetical list of functions (see *Menu Functions*, page 35). Scroll through the list with the **SELECT** knob and tap the knob to select an item. For items with only two or three values, tapping the **SELECT** knob toggles between the parameter values. For other items, you can turn the **SELECT** knob to choose the parameter value. Tapping the knob a second time un-selects the item and exits the menu. If you wish to terminate the item but keep the menu active, tap **MENU**. When you wish to exit the menu, tap **MENU** again.

## Programmable Function Keys

Most menu functions can be assigned to a function key by tapping or holding the **FN1** – **FN4** or **FN5** – **FN8** key while the menu item is displayed but not selected. The label for that function key will then change to the function name (when labels are turned on with the **LABELS** key).

**LABELS** toggles the function key labels on and off. Note that the function keys are still active even when the labels are turned off.



# Rear Panel Connectors

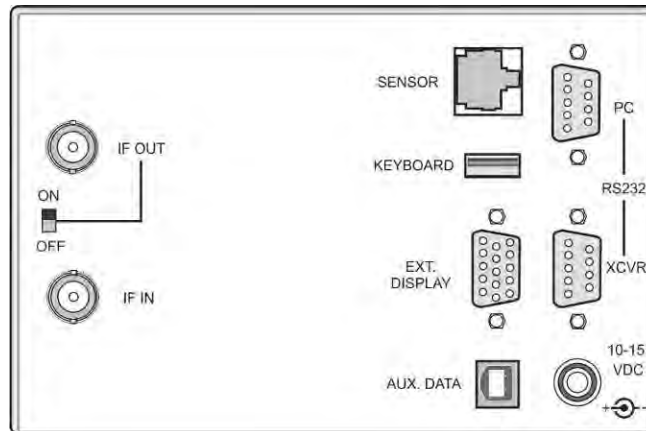

**I.F. Signals:** **IF IN** is a BNC jack that connects to the intermediate-frequency output connector of the transceiver (IF OUT on the K3). This should be a buffered, low-level, high-bandwidth signal from the receiver that is tapped off at a point before the high-selectivity filters.

**IF OUT** is a BNC jack that may be connected to any other device that needs the I.F. output signal from the transceiver. When the IF OUT switch is in the ON position, the IF IN signal is directed to a 3 dB splitter whose outputs feed both the P3 and the IF OUT connector.

**RS232 XCVR** is a male DE-9 connector that connects to the RS232 port on your transceiver (see diagrams on page 5 or page 6 for connections to a K3 or K3s). Use a straight-through cable (not a null modem). Note that communications between the transceiver and the P3 are always at a data rate of 38400 baud (see figure below). The K3 baud rate is set automatically by the P3 and cannot be changed at the K3.

**RS232 PC** is a female DE-9 that optionally may be connected to a personal computer that can be used for downloading new firmware and for sending and

receiving commands to the P3 and K3 (if connected). To set the baud rate, refer to the RS232 Menu entry on page 35. The baud rate also may be set by using the same RS232 command (BR) as for a K3. Refer to the *K3 or P3 Programmer's Reference* for details. To download firmware to the K3, see *Updating K3 Firmware* on page 31.

**Power: 10-15 VDC** is a standard 2.1 mm barrel connector for a 10-15 VDC supply. See *Connections* on page 4 if you wish to take power from the 12VDC OUT jack on the K3.

**The following are present only if the P3SVGA option is installed:**

**KEYBOARD:** USB jack for a USB keyboard or thumb drive (mass storage device). Apple keyboards are not supported at this time.

**EXT.DISPLAY:** Output to an external SVGA monitor.

**SENSOR:** Present only if the optional Transmit Monitor (Tx Mon) is installed.

**AUX DATA:** For future use.

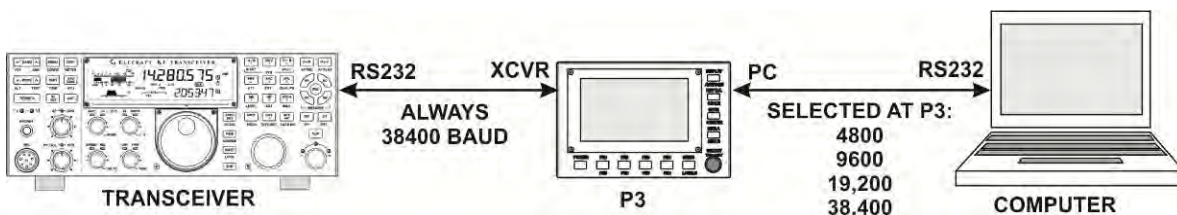

**RS232 Communications Path through the P3.**

# Basic Operation

This section covers the fundamentals of P3 operation. Once you're familiar with the P3, please go on to *Advanced Operating Features* (page.16).

## Using Tap/Hold Switches

Most P3 switches have two options. **Tapping** (pressing for less than 1/2 second) activates the function labeled in white above the switch. **Holding** (pressing for more than 1/2 second) activates the function labeled in yellow below the switch.

## Initial Power-Up

- Connect a power supply, I.F. input and (optionally) an RS232 cable (page 12).
- Press **POWER** to turn the P3 on, if it is not on already. The screen should light and you should see a spectrum or combined spectrum and waterfall display. If a K3 is connected via RS232 you should see the correct frequency at the top center of the display.

## Configuring the Display

Tap **DISPLAY** to cycle between spectrum and combined spectrum and waterfall displays.

Hold **AVERAGE** to turn on averaging and to set the averaging time constant with the **SELECT** knob.

You can hold **AVERAGE** again to turn off averaging or just tap the same key to clear the parameter-entry text from the display while leaving averaging enabled.

Hold **LABELS** to show or hide the function key labels.

There are also several **MENU** functions that configure the display, such as *LCD Brt* (display brightness), *Peak hold*, *Freeze display*, *Font size* and *Waterfall height*.

## Using the Menu

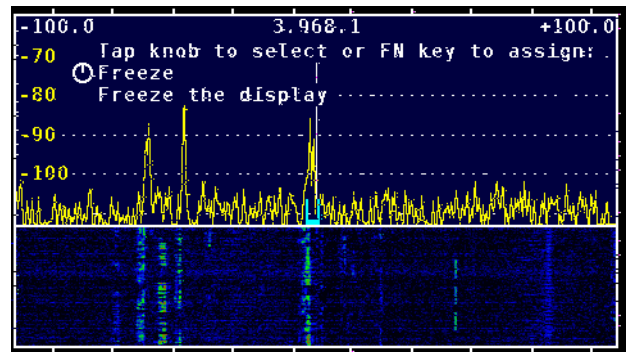

Typical Display Showing a Menu Selection.

- Tap **MENU** to access the menu.
- Turn the **SELECT** knob to scroll through an alphabetical list of available menu functions, as documented in the Menu Functions section (page.35).
- Tap the **SELECT** knob to select a function.
- Most functions have a parameter which can then be adjusted with the **SELECT** knob.
- Tap the **SELECT** knob again to exit the function.
- Tap **MENU** again to exit the menu.
- Some menu items are toggle functions. The parameter changes automatically every time you tap the **SELECT** knob.

## Programmable Functions

Most **MENU** functions can be assigned to any programmable function key, FN1 to FN8. Tap or hold the desired function key while the function is visible on the display but *not* selected by tapping the **SELECT** knob. The function name then becomes the function key label which can be seen if labels are currently displayed. To un-assign a function key, select *MENU:FN Erase* and tap or hold the function key you wish to erase.

Some menu items are much more useful when assigned to a function key. Examples are *Peak* hold and *Freeze* display.

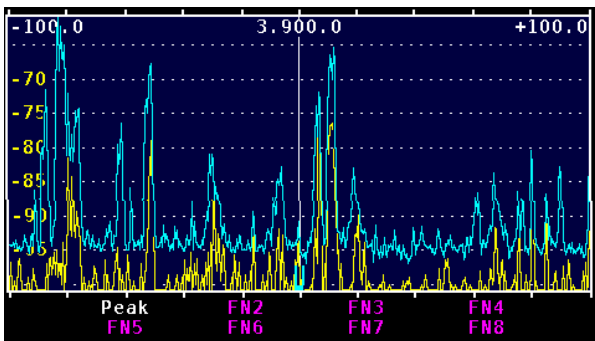

PEAK assigned to Function Key FN1.

## Adjusting the Amplitude

Tap **REF LVL** to adjust the reference level, which is the signal level that corresponds to the bottom of the spectrum display and the low-signal level of the waterfall display. Hold **SCALE** to adjust the "vertical gain" of the display. For example if the reference level is set to -100 dBm and the scale to 30 dB, then the top of the spectrum display is at -70 dBm and the bottom at -100 dBm.

The waterfall display is most useful if the reference level is adjusted to place the noise level near the bottom of the display and the scale is adjusted so that the strongest signals of interest are near the top.

## Adjusting the Frequencies Displayed

Tap **SPAN** to adjust the range of frequencies that can be seen on the display at one time. The start and stop frequencies are indicated at the top left and right of the display. They are shown as offsets from the center frequency in tracking mode and as the actual RF frequencies in fixed-tune mode.

Hold **CENTER** to adjust the display center frequency by turning the **SELECT** knob. This function may be disabled for tracking mode via *MENU:CenterEn*.

Hold **CENTER** again to re-center the display on the transceiver VFO frequency.

When used with the K3, an RF frequency is shown at the top center of the display. In tracking mode, it is the display center frequency, which normally is the K3 VFO A frequency. In fixed-tune mode it is always the K3 VFO A frequency. For transceivers other than the K3 it is the difference between the center frequency and the current transceiver frequency, normally zero.

The tic marks that appear along the top and bottom edges of the spectrum and waterfall widows indicate RF frequency in integer multiples of 0.5, 1, 2, 5, 10 or 20 kHz, depending upon the span.

## Using Markers

Tap **MKR A** to turn on marker A and allow you to change the marker frequency by rotating the **SELECT** knob. To determine the frequency of a signal, move the marker so that it overlays the carrier and read the frequency from the display. For single sideband signals, place the marker where the carrier would be if it were transmitted, i.e. on the lower (left) edge of an upper sideband signal and on the upper (right) edge of a lower sideband signal.

If a K3 is connected, you can QSY (change the frequency of) the K3's VFO A to the marker A frequency by tapping the **SELECT** knob. To return to the previous frequency, hold the knob. To turn off marker A, tap **MKR A** again.

Hold **MKR B** to turn on marker B and allow you to change the marker frequency by rotating the **SELECT** knob. If a K3 is connected, you can QSY the K3's VFO B to the marker B frequency by tapping the **SELECT** knob. To return to the previous frequency, hold the knob. To turn off marker B, hold **MKR B** again.

To turn off a marker you must first make it active, if necessary, by tapping **MKR A** or holding **MKR B**. Then tap or hold the key a second time to hide the marker.

If some other function that uses the **SELECT** knob is activated, the marker stays on and automatically becomes active again (you can adjust it with the knob) when the other function is terminated. The tap-to-QSY function affects VFO A if marker A is active and VFO B if marker B is active.

When a marker is turned on, it will be at the same frequency as the last time it was on unless that frequency is off-screen. In that case the marker is automatically reset to the display center frequency. (If you lose a marker off-screen, just turn it off and on again to return it to the center frequency.)

When you change bands on the K3, the markers are automatically set at the new center frequency.

For best frequency accuracy, especially when using narrow spans, perform the frequency calibration procedure on page 33.

## Waterfall Markers

Select *MENU:WfallMkrs*. Tapping the **SELECT** knob will turn the waterfall markers on, causing the marker line(s) to travel down into the waterfall display, or turn the markers off.

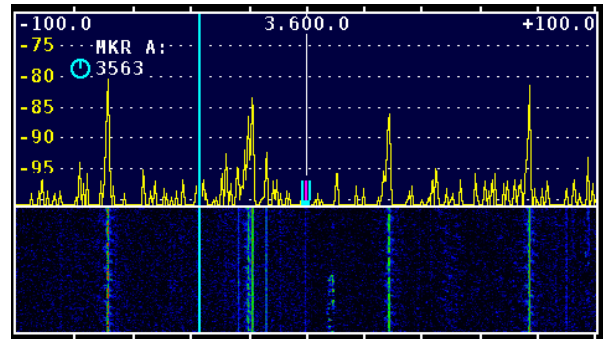

Marker A Enabled at 3563 KHz for Both Spectrum and Waterfall.

## Using Cursors

When used with a K3 transceiver, cursors show the position of the A and B VFOs, The position and width of each cursor shows the passband being received. Two cursor shapes may be selected using *MENU:CUSOR*, a translucent bar cursor or a “U” shaped cursor at the bottom of the spectrum display.

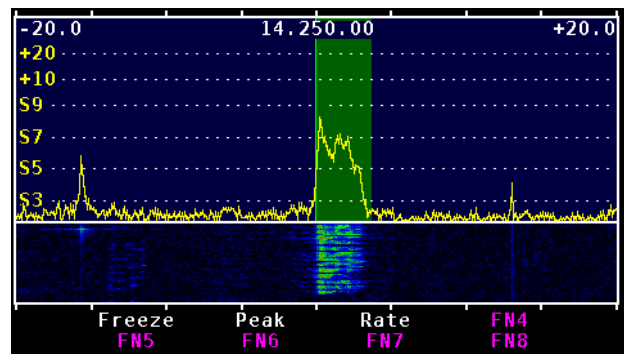

Bar Cursor on Upper Sideband Signal at 14.250 kHz

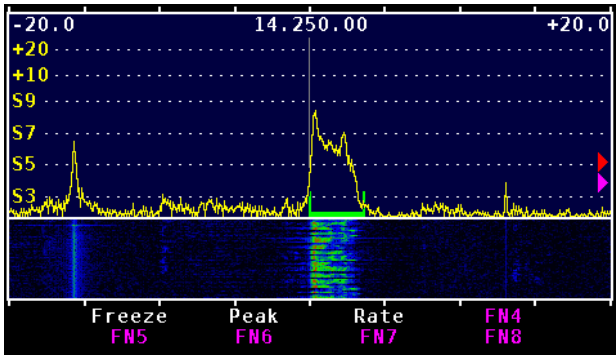

“U” Cursor on Upper Sideband Signal at 14.250 kHz

VFO A has a green cursor and VFO B has a magenta cursor unless split mode is activated at the K3. In split mode, the VFO B cursor changes to red as a reminder that you will transmit on that frequency. Similarly, if XIT is on, or if split is off and RIT is on, a new red cursor appears at the transmit frequency.

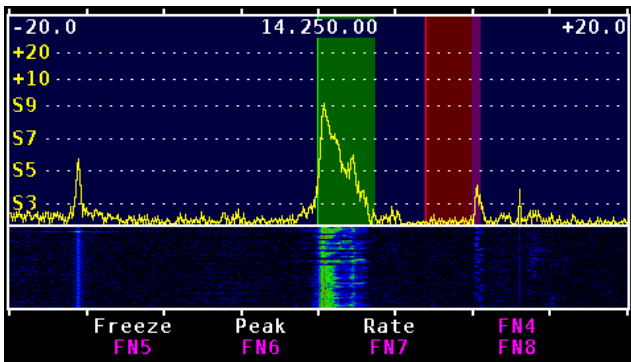

Red Bar Cursor Showing Transmit Frequency Above the Receive Frequency

Whenever a cursor is tuned off-screen a small arrow of the same color appears at the bottom left or right of the spectrum window to indicate the direction to the missing cursor.

The VFO B cursor may be turned off using *MENU:VFO B*. Tap the knob to select *ON* or *OFF* as desired.

## Noise Blanker

The noise blanker in the P3 reduces the effect of impulse-type noise on the display. It has little or no effect on other types of noise such as thermal noise and static crashes but can dramatically reduce impulse noise from sources such as the AC power line and the ignition systems of motor vehicles.

Turn the noise blanker on or off using *MENU:NB En* to *ON* or *OFF*. This can be assigned to a function key for access without entering the menu. This is a per-band setting. NB appears in the upper right corner of the P3 display when the noise blanker is on.

Adjust the aggressiveness of the noise blanker algorithm with *MENU:NB Level*. The higher the setting the more completely it blanks the noise but also the more likely it will cause distortion of desired signals. Use the lowest setting that effectively blanks the noise. A value of about 10 or 11 is a good starting point for experimentation. The noise blanker level setting is also per-band. Note that the **REF LVL** and **SCALE** settings have no effect on the noise blanker.

If one or more very strong signals are within the P3 displayed frequency range, the noise blanker has a hard time detecting the difference between the unwanted pulses and the wanted signals. The solution is to narrow the span and/or offset the center frequency perhaps using *Fixed-tune Mode* (see page 18) to place the strong signals well outside the P3's display range.

# How to Set Up and Interpret the P3 Display

There are several options to customize the layout of your P3 display. **DISPLAY** switches between a spectrum-only and spectrum-plus-waterfall display. The height of the waterfall can be adjusted with *MENU:Waterfall*. The function (FN) key labels appear at the bottom of the screen by default. You can hide them to maximize the screen area by holding **LABELS**. The FN keys remain active even when the labels are hidden. Another trick to maximize viewing area is to choose a smaller type font via *MENU:Font*.

## Spectrum Display

The spectrum display on a panadapter is similar to the display on a laboratory spectrum analyzer. The horizontal axis is frequency and signal strength is represented by the vertical height of each signal. The P3's spectrum display is similar to most in that the signal height is proportional to the logarithm of the amplitude, represented in decibels (dB). Each 3 dB represents a doubling of power and 10 dB means ten times the power.

The vertical scale at the left edge of the spectrum display may be in units of dBm or S-units, as selected by *MENU:Lvl Mode*. The dBm unit means decibels with respect to one milliwatt. 0 dBm is one milliwatt, +10 dBm is 10 milliwatts, -10 dBm is 1/10 milliwatt and so on. An S9 signal is normally considered to be 50 microvolts into 50 ohms, which is -73 dBm, an easy number for a ham to remember! Assuming the standard 6 dB per S-unit, the following table applies.

S-Units	Signal Level	
S9	-73 dBm	50 $\mu$ V
S8	-79 dBm	25 $\mu$ V
S7	-85 dBm	12.5 $\mu$ V
S6	-91 dBm	6.25 $\mu$ V
S5	-97 dBm	3.13 $\mu$ V
S4	-103 dBm	1.56 $\mu$ V
S3	-109 dBm	0.78 $\mu$ V
S2	-115 dBm	0.39 $\mu$ V
S1	-121 dBm	0.2 $\mu$ V

You would expect the S meter on the K3 and the signal on the P3 display to indicate the same level if both the K3 and the P3 are properly calibrated, however there are several reasons why that might not be the case. One is that the P3 is not affected by the preamplifier and attenuator in the K3. If the K3 *CONFIG:SMTR MD* is set to *NOR*, the S meter reading changes when you turn on or off the preamplifier and attenuator. To prevent that, change the setting to *ABS*.

The noise level will generally be lower on the P3 display compared to the K3 S meter. The reason is that the effective bandwidth of the P3 is generally one display pixel, which is approximately span / 450. The smaller the bandwidth, the less noise. For example, if the span is 45 kHz, the effective P3 bandwidth is  $45,000 / 450 = 100$  Hz. If the K3 bandwidth is 400 Hz, it will show a 6 dB (one S-unit) higher noise level than the P3.

A similar thing happens with spread-out signals like SSB. Even at the maximum 200 kHz span, the P3's effective bandwidth is only about 440 Hz so that not all the SSB signal is within one pixel. That's why the P3 tends to read a lower level on SSB signals than the K3 S meter.

**REF LVL** (reference level) on the P3 shifts all the signals up or down. The level that you are adjusting is the signal level at the bottom of the display, measured in dBm.

**SCALE** is used to expand or contract the vertical scale. Think of it as a vertical gain control. The scale is defined as the dB difference between the top and the bottom of the display. For example, if the reference level is -100 dBm and the scale is 20 dB, then a signal at the top of the display is at -80 dBm. For both **REF LVL** and **SCALE**, turning the knob clockwise makes the signals taller.

The P3 automatically compensates for the preamplifier and attenuator in the K3. When you turn them on or off, the signal levels on the P3 should stay the same. If the I.F. output modification has been done on the K3 (see note at the top of page 4), the indicated dBm level should be the signal level at the K3 antenna input. Perhaps counter-intuitively, this means that if you turn on

the preamplifier in the K3, the noise level displayed on the P3 may decrease, rather than increase. That is because the P3 automatically reduces its gain when the K3 preamplifier is turned on, in order to keep the signal levels the same.

## Waterfall Display

The waterfall allows you to see a history of band activity for the past few seconds. Like the spectrum display, the horizontal axis is frequency but in this case the vertical axis is time. Signal amplitude is represented by colors, from dark blue for weak signals, then brighter blue as signals increase in strength, through shades of green, yellow and red for the strongest signals. Each horizontal line represents one update of the spectrum display. As each new line is written the old ones are shifted down, creating a waterfall effect.

While the spectrum display is better at accurately displaying signal strength and the shape of a signal's modulation, it can only show what is happening right now. The waterfall is better for showing transient signals, such as a DX station running a pileup that only transmits for a few seconds at a time. Often, you can easily see a weak fading signal on the waterfall that is invisible on the spectrum display.

The scaling of the waterfall is the same as for the spectrum. That is, the bottom of the spectrum display corresponds to dark blue on the waterfall and the top corresponds to bright red. For maximum visibility of signals on the waterfall, it is best to set **REF LVL** so that the noise level is right at the bottom of the spectrum display and then expand **SCALE** as much as possible while keeping signals of interest below the top of the spectrum display. That improves the color contrast on the waterfall and makes weak signals appear to pop out of the noise.

## Averaging and Peak Hold

Another way to make weak signals more visible is averaging. Because noise is random in nature, averaging reduces the jaggedness of the noise spectrum trace, making signals easier to pick out. The more averaging the better the noise reduction, but at the expense of a slower response. To turn on averaging and adjust the averaging time, hold

**AVERAGE** and then turn the knob. The averaging time is in units of the spectrum update rate, typically about 50 ms. You can apply averaging to the waterfall as well by setting *MENU:Wfall Avg* to *On*.

Peak hold is a way to display a memory of past signals on the spectrum display. It shows the strongest signals that have appeared at each frequency since the last time peak mode was enabled. To reset the peak trace, simply disable peak hold and then re-enable it. This mode is most useful if you assign *MENU:Peak* to a FN key so you can turn it on and off at the touch of a button.

One use for peak hold is to monitor a dead band for activity while you are away from the operating position. If you glance at the display every now and then you can see if any signals have appeared in the meantime. Peak hold is also useful to see the shape of a modulation spectrum. Since the sidebands are continually changing with modulation, the peak is a better indication of the spectrum than the instantaneous value.

## Span

Adjusting the span is yet another way to make weak signals more visible. As you narrow the span, there is less noise within the range of each frequency display point. That reduces the apparent noise level while the signal levels stay the same, which increases the signal-to-noise ratio. At narrow spans, signals that are difficult or impossible to hear become visible, especially on the waterfall.

As mentioned before, it is useful to keep the noise level right at the bottom of the display. The P3 can automatically keep the noise level constant as you adjust the span by setting the menu *MENU:SpanScale: REF LVL only*. If you would also like the level at the top of the screen to remain constant as you adjust the span, set *MENU:SpanScale: REF LVL & Scale*.

## Fixed-tune mode

When the P3 is used with a K3 transceiver, the center frequency on the P3 screen normally follows along as you tune VFO A on the K3. This is called *tracking* mode. In this mode, the frequency displayed at the top center of the screen is the display center frequency, and the labels at the top left and right show the frequencies of the left and

right edges of the display, in terms of their offset from the center. Usually, the VFO A frequency is at the center of the P3 display unless you have offset it with the P3's **CENTER** control. The display can be re-centered at any time by holding the **CENTER** key while already in center-frequency mode, which can be accomplished by holding the **CENTER** control twice.

In *fixed-tune* mode the frequencies on the P3 display stay fixed as you tune VFO A. The VFO A cursor moves across the screen instead of always being at the same position, as it is in tracking mode. You can toggle between fixed-tune and tracking modes via *MENU:FixTrack*. Fixed-tune mode is only available with the K3 transceiver.

The three frequency labels at the top of the screen have different meanings than they do in tracking mode. The one at the center is always the VFO A frequency, even when it is not at the center of the display. The labels at the top left and right are the actual RF frequencies that correspond to the left and right edges of the display, rather than the frequency offsets from the center.

If you tune VFO A past the left or right edge of the screen, one of four things can happen depending on the *MENU:FixMode* selection. If the mode is set to *Full span* the center frequency jumps up or down one full screen width whenever you tune past an edge so as to keep the VFO A cursor on the screen. If the mode is *Half span*, the center frequency jumps one-half screen width. In *Slide* mode, it moves the minimum amount necessary to keep the cursor on the screen. In *Static* mode, the center frequency is truly fixed; the VFO A cursor is allowed to disappear off-screen. In both tracking and fixed-tune modes, whenever either the VFO A or VFO B cursor is tuned off-screen, a small arrow at the bottom left or right of the display points in the direction of the missing cursor. The arrow color matches the cursor color.

When you switch between tracking and fixed-tune mode, the span stays the same. The center frequency also stays the same when switching from tracking to fixed-tune mode, but defaults to the VFO A frequency when going from fixed-tune to tracking mode. In either mode, the center frequency and span can be adjusted using the **CENTER** and **SPAN** keys (unless the **CENTER** key has been disabled for tracking mode with *MENU:CenterEn*).

The selection of fixed-tune or tracking mode is global, that is, it is the same on all bands and it is remembered when cycling power. In fixed-tune mode, the center frequency and span are stored in non-volatile memory per band. When changing bands or when turning on power, the last values used on that band are remembered, unless that would put the VFO A cursor off-screen, in which case the display is re-centered on VFO A. The only exception is Static mode, where the only way to change the center frequency or span while fixed-tune mode is in effect is to adjust the **CENTER** or **SPAN** keys.

## Typical Spectra

Below is a typical screen shot of the 40 meter band during the day. At the center is a weak CW signal that was inaudible on the K3 transceiver during fades. It is hard to see on the spectrum display at the top but is clearly visible on the waterfall. Just to the right of that is a strong interfering carrier. At the far right is another steady carrier and just to the left of that is a spurious emission, probably from a switching power supply, that is wavering back and forth in frequency. A panadapter is a powerful tool for tracking down interference.

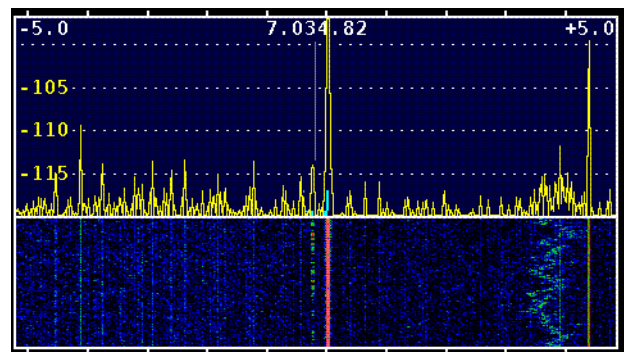



This is another example of interference, this time from a LAN router. The QRM includes both wideband noise as well as discrete carriers and is constantly heaving and writhing as the processor in the router executes different portions of its software routines.

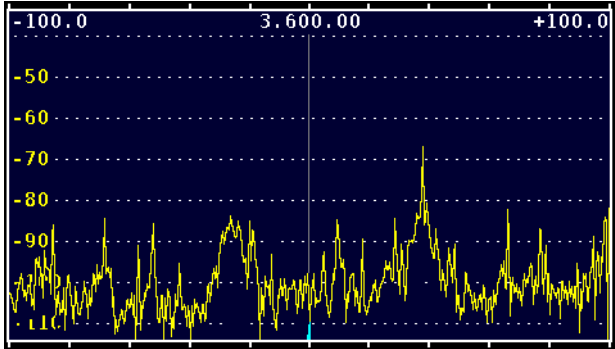

Spurious signals generated in the transceiver are sometimes visible as well. As you tune the transceiver you may see carriers that scroll across the screen much faster than other signals, sometimes tuning in the opposite direction. These are created by high-order harmonics of the VFO, BFO and other signal sources in the transceiver. Normally you won't hear them in the receiver unless one falls within the I.F. passband, but they are easy to see on the panadapter display because of its much wider bandwidth.

This is a shot of a local AM broadcast station, illustrating the use of peak hold to show the shape of the modulation spectrum, which extends to plus and minus 10 kHz from the carrier and then drops off abruptly to meet FCC regulations.

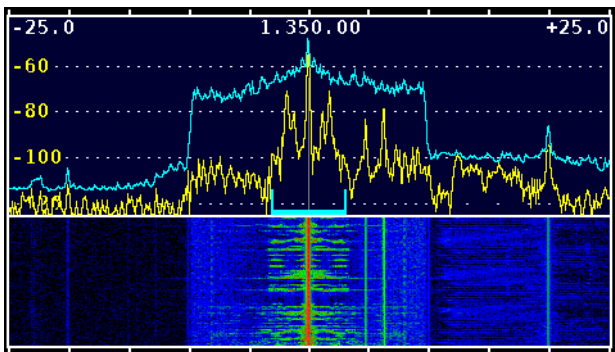

Normally the P3 display is frozen while the K3 is transmitting. However if you temporarily disconnect the RS232 cable between the P3 and K3, that function is disabled and it is possible to view your own transmissions for test purposes. The

signal level is rather weak as it depends on random leakage in the K3's I.F. chain, so you may need to experiment with **REF LVL** on the P3 and the power level and frequency band on the K3 to get an adequate signal. Also, the frequency may not be exactly centered on the display due to the effect of crystal filter offsets in the K3.

The following image shows a typical LSB spectrum obtained in this way. Peak hold is enabled in order to get a better view of the spectrum shape. Notice that the low audio frequencies (on the right) are much stronger than the high audio frequencies. A flatter spectrum is considered desirable to improve the signal's "punch" in the presence of noise and interference, especially when speech compression is used. The P3 is a handy tool for adjusting the transmit equalizer in the K3.

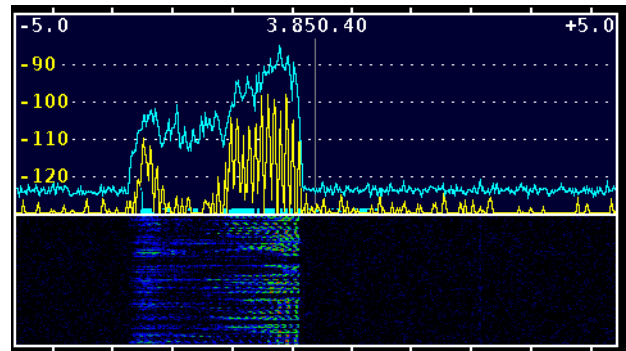

The previous image also illustrates an important point when using markers. On SSB, the frequency that is shown on the display of the K3 transceiver is the suppressed carrier frequency. When you QSY the K3 using MKR A or MKR B on the P3 you should place the marker just above the spectrum of a lower sideband signal you are trying to net (approximately in the center of the above display) and just below the spectrum of an upper sideband signal.

# Advanced Operating Features

## Basic P3

### *Use with Other Radios*

The P3 can be used with any receiver or transceiver that has means to output an intermediate-frequency (I.F.) signal between approximately 455 kHz and 21.7 MHz. Frequencies a little beyond that range can be used at reduced sensitivity.

The I.F. may be selected via *MENU: Xcvr Sel*. If you are not sure what frequency is used by your receiver, apply a test signal to the receiver antenna and scroll through the menu list until you see the signal on the display. Many receivers use an inverted I.F., meaning that signals tune in the opposite direction, so many of the selections include that feature. As you tune the receiver upwards in frequency the signal should move to the left on the display.

If the correct I.F. is not in the list, the frequency of the *USER* selection may be set manually via *MENU: Xcvr Def*.

```
==== User transceiver definition ====
IF: 1 - 10 kHz digits:
⊙ 15

Language      Name
  K3          USER
IF tuning     IF center frequency
Inverted      8215.000 kHz

Language <=>Name=>  ↕Name↕  EXIT
Invert    100 kHz  1 kHz    1 Hz
```

### ***Xcvr Def* Display.**

*Xcvr Def* also allows you to select between inverted and non-inverted I.F., change the name "USER" to something else, and select the programming language (currently either None or K3).

The *Xcvr Def* function temporarily re-defines the function (FN) keys with legends across the bottom of the display as shown above. There are three keys to set the frequency in 100 kHz, 1 kHz or 1 Hz steps.

The FN2 and FN3 keys are used for changing the transceiver name. The one with the horizontal arrows selects the character position as you rotate

the **SELECT** knob and the one with the vertical arrows selects a character from a list by rotating the knob.

Tap **FN4** (EXIT) to return the P3 to normal operation.

### ***Use with Transverters***

The I.F. output of many transceivers tunes backwards. For example, the K3's I.F. output is inverted on all bands except 50 MHz. The P3 takes this into account automatically. However, if you are using an external transverter, the tuning direction depends upon whether the band it converts down to is the 50 MHz band (not inverted) or some other band (inverted).

To configure the P3 so the displays moves as expected regardless of the tuning direction, select *MENU:XV Invert*, tap the **SELECT** knob, and adjust the knob to select the desired transverter band: 1-9. Tape the knob again to select either "Inverted" or "Not Inverted".

See also *Amplitude Calibration for Transverters* on page 35. If you are using your P3 with an Elecraft K3, the K3 Owner's manual contains more information about working with transverters.

### ***Remote-Control Commands***

Many P3 functions may be accessed by remote-control commands sent via RS232. These commands use ordinary ASCII text, so they can be tested using a terminal emulator or the Command Tester tab in P3 Utility. When the P3's XCVR RS232 port is connected to a K3, then both P3 and K3 commands may be sent and received via the PC RS232 port.

To distinguish them from K3 commands, P3 commands begin with the "#" symbol. For example, "#RVM;" returns the P3 firmware revision and "RVM;" returns the K3 main firmware revision. P3 remote-control commands are fully described in the *P3 Programmer's Reference*.

## ***P3 Utility Program***

In addition to downloading firmware (page 28) the P3 Utility can perform several other functions. For example, it can upload a bitmap image of the P3 display which can be saved to a file or pasted into a graphics program on the computer. Refer to the Help menu in P3 Utility for more information.

## **P3SVGA Option**

The following functions are applicable only if the P3SVGA board is installed and enabled.

Tap **MENU** and then turn the **SELECT** knob to *SVGA menu*. Tap the **SELECT** knob enter the sub-menu.

### ***SVGA Display On/Off***

The external display is activated automatically when the P3 is turned on. You can turn the external display off or on from the SVGA sub-menu. In the SVGA sub-menu, turn the **SELECT** knob to *SVGA en* and then tap the **SELECT** knob again to toggle between *SVGA on* and *SVGA off*.

### ***SVGA Firmware Version***

In the SVGA sub-menu, turn the **SELECT** knob to *SVGA FW* and then tap the **SELECT** knob again to display the installed SVGA firmware version.

### ***Set Resolution***

In the SVGA sub-menu, turn the **SELECT** knob to *SVGA res* and then tap the **SELECT** knob again. Turn the **SELECT** knob to select the desired resolution. Note that there are two 1920x1080 resolutions available, normal and “alt”. These have different pixel clock rates. Use the one that works best on your monitor.

## ***Spectrum Display Fill***

This setting fills the space below the spectrum line or leaves it open as shown in *SVGA Spectrum Display Fill* below. It does not have any effect on the waterfall display or the spectrum display on the P3’s internal screen. In the SVGA sub-menu, turn the **SELECT** knob to *SVGA fill* then tap the **SELECT** knob to toggle the fill on or off.

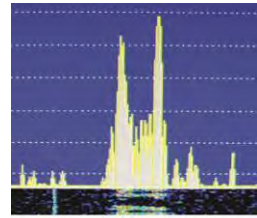

SVGA fill on

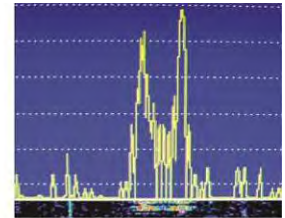

SVGA fill off

### **SVGA Spectrum Display Fill.**

### ***SVGA Font Size***

In the SVGA sub-menu, turn the **SELECT** knob to *SVGA font* and tap the **SELECT** knob again. Turn the **SELECT** knob to change the font size. Three sizes are available, 0, 1 and 2, shown in the upper left of the internal P3 display. The change will appear after a brief interval on the SVGA monitor so you can see the effect of the change without leaving the menu.

### ***SVGA Waterfall Color Bias***

In the SVGA sub-menu, turn the **SELECT** knob to *SVGA waterfall color bias* and tap the **SELECT** knob again. Turn the **SELECT** knob to change the bias value (shown in upper left corner of the P3 internal display). The change will appear immediately on the SVGA monitor waterfall display so you can see the effect without leaving the menu.

### ***SVGA Data Terminal Display***

In the SVGA sub-menu, turn the **SELECT** knob to *SVGA data* and tap the **SELECT** knob again. See *Data Terminal Setup* on the following page for complete information on using the data terminal functions.

## Data Terminal Setup

Data terminal mode adds three windows at the bottom of the SVGA monitor: one for received data, one for transmitted data and a status bar as shown below. These windows occupy part of the area used by the waterfall display. The height of

the status bar is fixed. The sizes of the receive and transmit data windows, and the sizes of the fonts used for them, are variable using the setup menu as described below.

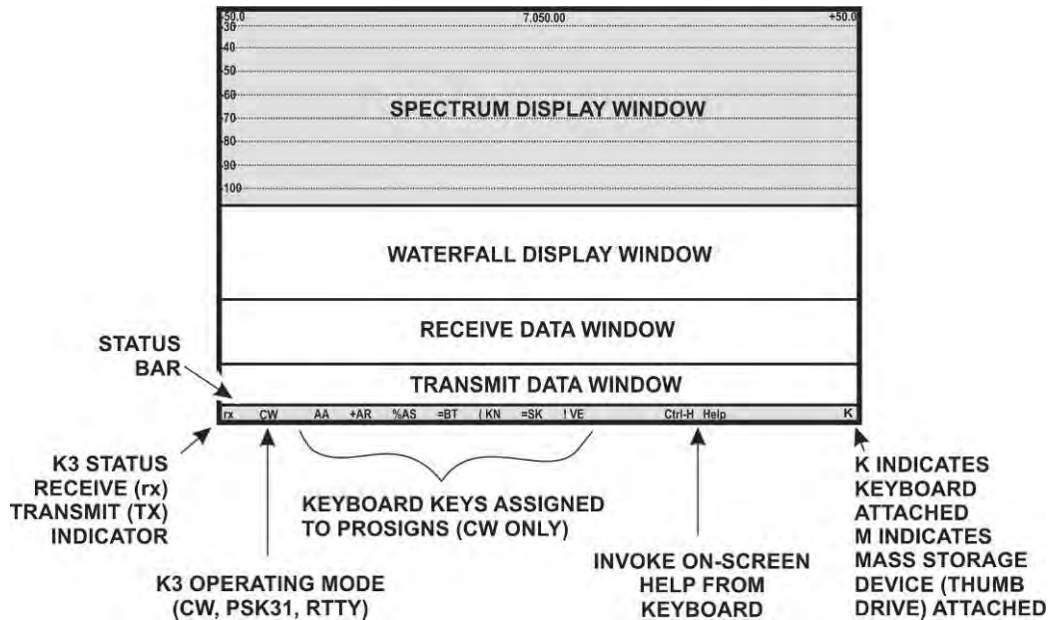

SVGA Display with Data Terminal Mode Enabled.

### Decoding Text

The decoding of signals takes place in the K3. See your K3 Owner's manual for details about how to configure the K3 to decode text in CW and each of the data modes.

### Adjusting the Receive and Transmit Windows and Font Sizes

The area occupied by the receive and transmit data windows depends upon the font size and monitor resolution used. Since the data windows occupy part of the space normally available to the waterfall display, you may need to increase the size of the waterfall display to provide room for them.

If the transmit data window size is set to zero, data transmission is disabled, the transmit data window will disappear and the keyboard becomes inactive.

To set the window and font sizes, tap **MENU** and then turn the **SELECT** knob to *SVGA menu*. Tap the **SELECT** knob enter the sub-menu. Turn the **SELECT** knob to the desired parameter tap the **SELECT** knob again. Turn the **SELECT** knob to change the parameter:

- *SVGA WinR* - Sets the size of the receive data window (in lines).
- *SVGA WinT* - Sets the size of the transmit data window (in lines).
- *SVGA fntD* - Sets the size of the font. 0 is the smallest, 3 is the largest.

## ***Transmit Setup***

### **Using the Keyboard**

An upper case K in the right hand corner of the SVGA display status bar (see *SVGA Display with Data Terminal Mode Enabled* on page 23) indicates

that the keyboard is connected and active. Keyboard shortcuts are listed below. (Hyphenated keys must be pressed at the same time.)

### **Keyboard Shortcuts**

<b>KEYS</b>	<b>FUNCTION</b>
<b>Ctrl-H</b>	Opens help screen except when editing messages or macros. Press any key to exit.
<b>Backspace</b>	Deletes character to the left.
<b>Ctrl-Backspace</b>	Deletes word to the left.
<b>Ctrl-Alt-M</b>	Opens K3 macro entry pop-up window.
<b>Ctrl-Alt-T</b>	Opens text messages pop-up window.
<b>Ctrl-Alt-S</b>	Opens setup menu.
<b>Ctrl-Alt-B</b>	Starts beacon transmit.
<b>Esc</b>	Switches K3 to receive and clears the transmit data window.
<b>Scroll Lock</b>	Freezes receive data window. Press again to resume.
<b>Ctrl-T</b>	Resume transmission.
<b>Ctrl-Alt-R</b>	Replays the transmit buffer.
<b>Scroll Lock</b>	Freezes the receive data window.
	When inserted into a text message, causes the K3 to revert to receive mode at the end of the message.

**NOTE:** On-screen menus use the carat, ^ (upper case 6), to denote the Control (Ctrl) key

## Setup Options

The transmit mode options and text color parameters that you can set are listed below. Press Ctrl-Alt-S to open the setup menu on the SVGA screen. This screen will cover the transmit data window and status bar temporarily. Use the up/down arrows on the keyboard to select a parameter and the left/right arrows to change the parameter. Pressing Ctrl-arrow changes the values in larger steps. Press Esc to save the changes and close the menu. The parameters are saved in non-volatile memory so they will be retained after power has been turned off and then on again.

### **Transmit Mode: CR, ^T, VOX**

Allows you to control when text entered on the keyboard is sent:

- CR: The K3 will start transmitting the text only after the Enter key is pressed.
- ^T: The K3 will start transmitting the text only after Ctrl-T is pressed.
- VOX: The K3 will transmit each character as it is typed on the keyboard.

**A** Pressing Ctrl-R will interrupt a transmission. In CR or VOX modes, press Enter to restart a transmission. In ^T mode press Ctrl-T to restart the transmission. Pressing Esc stops the transmission and clears any unsent text.

## Text Message Entry

There are 50 text message memory locations available that can be used in CW, RTTY or PSK modes. Each location can store up to 124 characters (including spaces). These messages are stored in non-volatile memory so they will not be lost when power is cycled. Create a text message as follows:

- Press Ctrl-Alt-T to enter the text message window. The window opens on top of the data and status windows. Press the up and down arrows to find an available (empty) message location (indicated by an <empty> key assignment), or you can select a message that is no longer needed. The example below shows that memory location 1 is available.

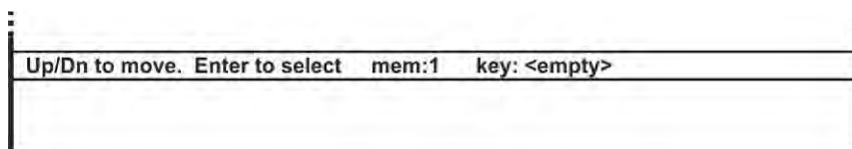

**Empty Text Message Location.**

### **Transmit Timeout: 0 to 90,000 ms (0 to 90 seconds) in 200 ms (0.2 second) increments.**

The length of time an idle signal will be transmitted in PSK or RTTY modes after the last character is sent. Any character entered on the keyboard during this time will be sent and the timeout period will start over. Pressing | (the vertical bar) on the keyboard will terminate the delay and return the K3 to receive mode immediately.

### **Transmitted Text Color: 1 to 50**

The color of the text in the transmit data window changes as each character is sent. Use this parameter to choose the color of the characters after they have been sent.

### **Tx Text Color: 1 to 50**

*Use this parameter to choose the color of the unsent characters in the transmit data window.*

### **Rx Text Color: 1 to 50**

Use this parameter to choose the color of the text shown in the receive data window.

### **Beacon Text Mem# and Beacon Interval**

See *Beacon Mode* on page 27.

- Press Enter to use the selected memory location.

Press the key to assign, ^C clears, ENTER no change

#### Assigning a Recall Key.

- Press the key(s) that you want to use to recall this message. In the example *Editing a Message* shown below, the ALT-B key combination was assigned to the message. If the name of the key does not appear when it is pressed, it has already been assigned to another message. You must choose a different key.
- Enter the text of the message. In this example the message is “Rig is an Elecraft K3 with P3/SVGA.” Correct errors using the Backspace, Ctrl-Backspace or Ctrl-C keys as needed.

Enter text, press ENTER when done, Ctrl-C to clear mem:1 key: Alt-B
Rig is an Elecraft K3 with P3/SVGA.

#### Editing a Message.

- When finished, press Enter to save the message and prepare to select the next location and enter another message. When finished, press Esc to exit.
- To send a message, press the assigned key to recover any message. In this example, pressing Alt-B transfers the test message to the transmit text window and begins transmission.
- To edit a message, select it and return to the *Assigning a Recall Key* or *Editing a Message* screens and make the desired changes. To erase a message select it and, at the key assignment window, press Ctrl-C.

## ***Beacon Mode***

Beacon mode transmits a text message repeatedly with a time interval between each transmission. The message is stored in memory in advance. You choose the message and the time interval desired. The message will be transmitted using the mode selected at the K3: CW, RTTY, or PSK.

Set up a message to be sent as a beacon as follows:

- Store your message to be sent (see *Text Message Entry*, page 9). You can use any memory location. Press Esc when you are done entering the message. Note that the key assigned to the message when you stored it in memory is not used when transmitting it in beacon mode. The key is used only when manually choosing a message to send.
- Press Ctrl-Alt-S to enter the setup screen.
- Press the down arrow key to select Beacon Text Mem #.
- Use the right/left arrows to enter the memory location where the beacon message is stored. Right arrow increments the numbers by 1 and left arrow decrements the number by 1. Ctrl-Arrow moves the count in steps of 10.
- Press the down arrow to Beacon Interval.
- Press the right/left arrows to select the desired interval between transmissions. You can select any interval between 0 and 3600 seconds (1 hour). Right arrow increments the numbers by 1 and left arrow decrements the number by 1. Ctrl-Arrow moves the count in steps of 10.
- Press Esc to exit the setup screen.
- Press Ctrl-Alt-B to start the beacon transmission. A flashing letter B will appear in the lower right corner of the status line.
- If a station answers, you may:
- Press Esc. That stops the transmission and clears the transmit window. You can then type a reply that will be transmitted immediately or when you enter CR or ^T,

depending upon the transmit mode you have selected (see *Transmit Mode: CR, ^T, VOX* on page 25).

- Start typing your reply. This automatically cancels further beacon transmission but does not interrupt the beacon message while it is being transmitted. Your reply will be transmitted immediately after the beacon message. You do not need to initiate transmission.

## ***Using Macros***

Macros are used to automate a sequence of control setting and button pushes on the K3 so that they may be accomplished with a single entry on the keyboard. For example you may want to create macros to shift the K3 into a particular mode on a specific frequency or band by a simple one or two key entry on the keyboard. You can create and enter up to 50 macros of up to 124 characters each. They are stored in non-volatile memory so they will not be lost when power is cycled. These memory locations are independent of the message memories. You can store 50 messages and 50 macros at the same time.

### **Entering Macros**

Press Ctrl-Alt-M to open the macro entry window. The process of entering the various windows, assigning a key used to recall the macro and editing macros is identical to that used for text messages. See *Text Message Entry*, above. Note that to enter the text message entry window you pressed Ctrl-Alt-T but you must press Ctrl-Alt-M to enter the macro entry window.

### **Sample Macro:**

Assign a macro memory to the F1 key (see *Assigning a Recall Key* on page 26) and enter and save the following macro (see *Editing a Message* on page 26):

```
FA00014970000;MD6;FA00014070000;DT3
```

Now pressing F1 on the keyboard will send the above macro to the K3 setting VFO A to 14.070 and the mode to DATA, PSK31.



**⚠** When creating a macro, pressing ^F will place the K3's current frequency (including RIT) into the macro in the form of an FA command. For example, if VFO A is set to 7.123 and ^F is pressed while entering the macro, FA00007123000; will be inserted into the macro string.

For more information about writing macros, refer to the *K3 Programmer's Reference* available on the Elecraft web site at [www.elecraft.com](http://www.elecraft.com) or the *K3 Utility* help screens.

### **Screen Capture**

There are two ways you can capture a bitmap image of the P3 display:

1. Use the P3 Utility program with a computer. With your computer connected to the P3 and the P3 Utility Program running, click on the CAPTURE IMAGE tab.
2. Write a bitmap directly to a thumb drive plugged into the KEYBOARD jack on the back of the P3 as follows:
  - With the thumb drive plugged into the KEYBOARD jack, tap **MENU** and then turn the **SELECT** knob to *SVGA menu*.
  - Tap the **SELECT** knob enter the SVGA sub-menu and turn the **SELECT** knob to *Ubmp*.
  - Tap the **SELECT** knob to start the capture. The time required to capture the image varies according to the resolution you have set. If you want to abort the capture, tap **MENU**.

## **Transmit Monitor (TX Mon) Option**

### **Firmware Required**

You must have firmware version 1.41 or later installed in your P3 to use the transmit monitor. See *Firmware Upgrades* on page 31 for details about installing the latest version of the P3 firmware.

**⚠** While most thumb drives are supported, some will not work. You'll have to test the drives you have on hand.

The .BMP files are named in sequential order starting with 00000001. The time stamp on all captured files is fixed. It does not indicate the actual time of the file capture.

### **Test Message and Macro Save and Restore**

Text messages and macros created on the P3 in Data Terminal mode can be saved to a thumb drive and restored as needed.

1. Plug the thumb drive into the KEYBOARD jack on the back of the P3
2. Tap **MENU** and then turn the **SELECT** knob to the *SVGA menu*.
3. Tap the **SELECT** knob enter the SVGA sub-menu and turn the **SELECT** knob to *SVGA Usav*.
4. Tap the **SELECT** knob to save the file. The data is saved in a file called SVGASET.SAV

To restore the file, repeat the above but turn the **SELECT** knob to *SVGA Urst*.

**⚠** While most thumb drives are supported, some will not work. You'll have to test the drives you have on hand.

The time stamp on all captured files is fixed. It does not indicate the actual time of the file capture.

### **Setup**

Connect the Sensor to your antenna system, transmitter and the P3 as shown on the following page. Be sure the TRANSMITTER connector on the sensor goes to your transmitter output and the LOAD connector goes to your antenna system or dummy load. Reversing them will produce erroneous readings on the display.

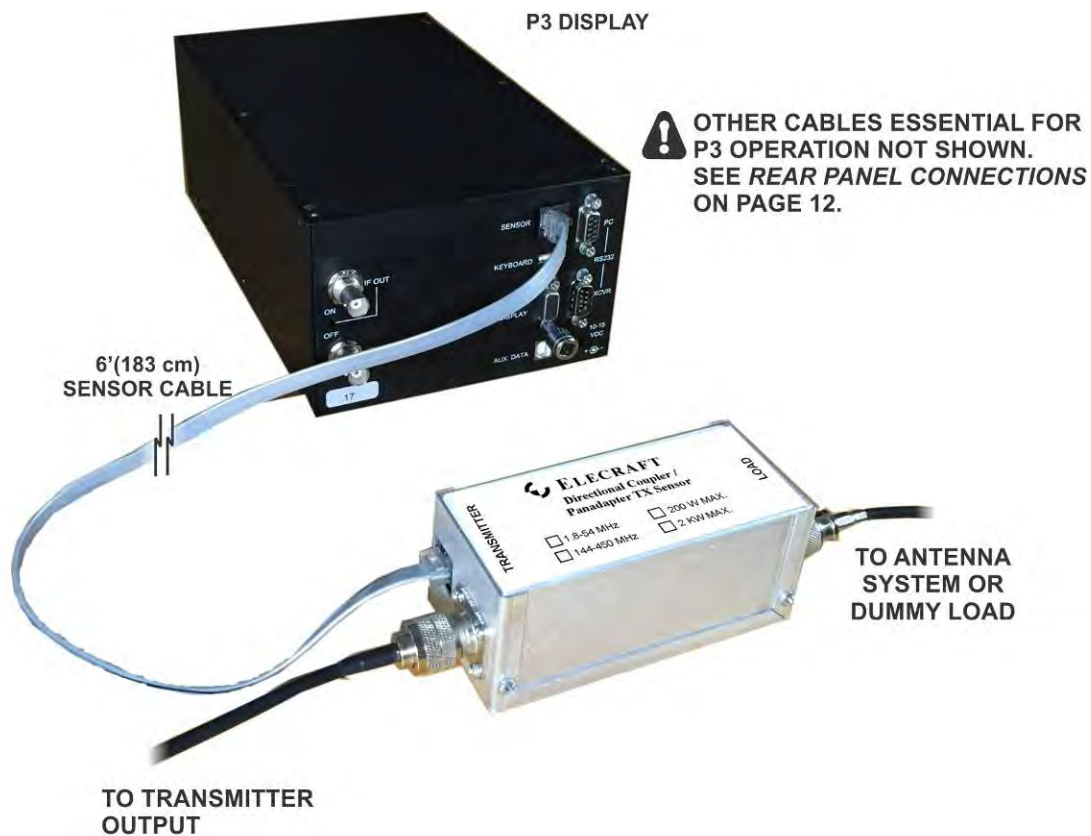

### Transmit Monitor Sensor Connections.

#### *Tx Mon Display*

The envelope display replaces the spectrum display on the P3 main monitor during transmit. A typical transmit monitor display is shown on the next page.

**⚠ The transmit monitor display appears only on the main P3 display. It does not appear on an external monitor used with the SVGA option.**

- The receive spectrum display is replaced by the transmit monitor RF envelope display. If the waterfall display is enabled the RF envelope display will occupy only that part of the display used by the receive spectrum display. This display can be turned on and off with ModEn in the TXMonMenu.
- The RF envelope display appears when the Sensor detects RF power and remains for

the duration of the transmission plus a "hang" period determined by the value set in TX hang in the TXMonMenu.

- The PEP power output and SWR displays are turned on and off using Mtr En in the TXMonMenu. The power output and SWR are shown with the bar graphs and displayed digitally.
- The PEP power output bar graph shows both current power with the moving bar and the peak power achieved with a narrow bar. Set the desired power scale using Mtr Scale in the TXMonMenu.
- The horizontal scale of the envelope display is adjustable using ModScale in the TXMonMenu

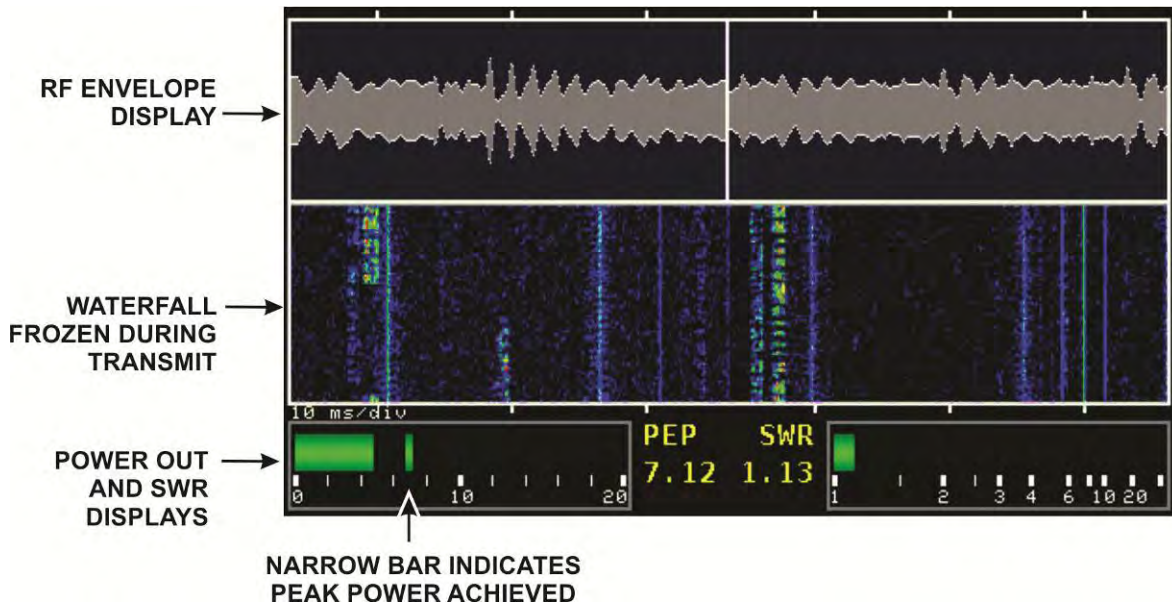

Typical Transmit Monitor Display

CW keying rise time and waveform are also displayed. Both the rise and fall waveform may be displayed using CW Split in the TXMonMenu (see below). Note that in this illustration the waterfall

display is turned off so the spectrum display and the waveform display fill the main part of the screen

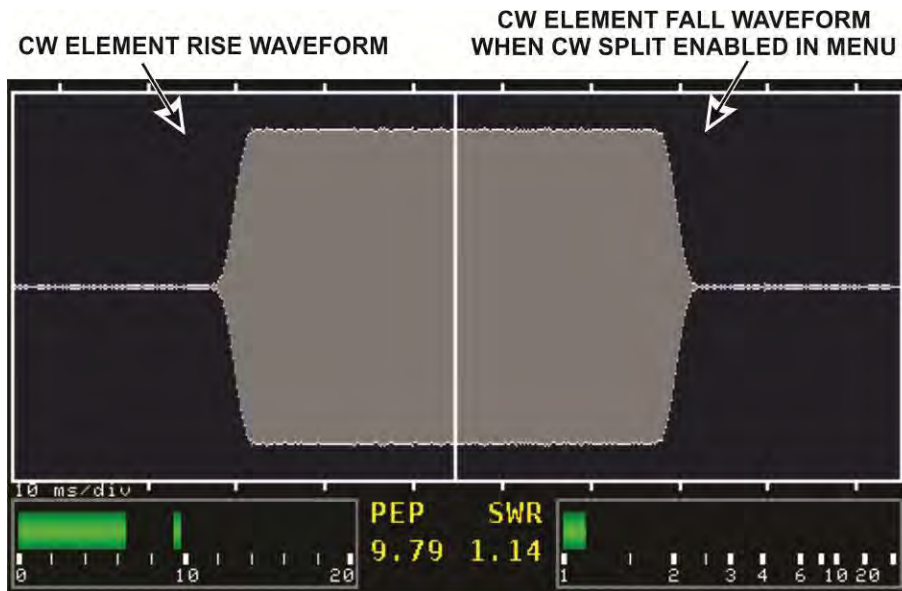

Typical CW Rise and Fall Time Display

# Firmware Upgrades

New features and improvements are available to all P3 owners via firmware upgrades.

Please visit the Elecraft K3 software page ([www.elecraft.com](http://www.elecraft.com)) to obtain our free firmware download application, *P3 Utility*. Versions of the Utility program are provided for PCs, Macs, and Linux platforms.

**⚠ Some applications or peripheral devices may interfere with P3 downloads; check the Help information in *P3 Utility* if you have difficulty.**

If you don't have Internet access, you can obtain a firmware upgrade on CD. If you don't have a computer, you can send your P3 to Elecraft to be upgraded. See Customer Service, page. 8.

## Checking your Firmware Revision

Use the MENU entry *FW Rev* to determine your firmware revision.

## P3 Firmware Self-Test

The P3 checks for firmware errors at turn-on. If an error occurs, the P3 Boot Loader is started automatically. Connect the P3 to your computer and reload firmware.

## Forcing a Firmware Download

If you accidentally load an old or incompatible firmware version and find the P3 unresponsive, do the following: (1) Disconnect the P3 from the power supply and wait 5 seconds; (2) connect the power supply again while holding the P3's POWER switch in; after about 10 seconds you'll see the Boot Loader screen; (3) load the correct firmware version.

## Updating K3 Firmware

If you have the P3 XCVR port connected to the K3 RS232 port, you can update your K3 firmware without disconnecting the RS232 cables to the P3. The K3 utility program automatically puts the P3 into a special pass-through mode until downloading

the K3 firmware is complete. If an older version of P3 firmware is installed that does not support this mode (00.36 or earlier) then the K3 Utility will prompt you to turn off the P3 before beginning the download. Turning the P3 off automatically bypasses the P3 so there is a direct connection between the computer and the K3. If you have configured the P3 so you cannot turn it off with the **POWER** switch (see *Configuration* on page 31), unplug the power connector on the P3's rear panel. Leave the P3 off until the download is finished.

### *K3 MCU LD Error*

If you accidentally cycle power on the K3 or P3 while downloading firmware to the K3, the K3 may become unresponsive in bootstrap mode (MCU LD displayed on the K3's LCD). Clear the condition as follows:

- Turn the P3 off.
- If the P3 is configured to turn on automatically when power is applied to the K3, disconnect power from the P3's rear panel. It's important that the P3 remain off throughout the procedure.
- Disconnect power from the K3's rear panel.
- Exit the K3 Utility program at your computer.
- Reconnect power to the K3's rear panel and turn the K3 on. Be sure the P3 does not come on with the K3. If it did, repeat the procedure from the beginning and be sure to unplug the P3's power cable. It won't work to turn the P3 off once it has turned on.
- Restart the K3 Utility at your computer, and reload the firmware.

## Configuration

The front panel **POWER** switch may be bypassed so the P3 turns on when power is applied. This is useful to turn the P3 on automatically when it is powered from the auxiliary jack on a transceiver such as the Elecraft K3 so the P3 turns on with the transceiver.

To configure the power control, remove the six flat head screws holding the P3 top cover and lift it off.

A small slot is provided in the cover so you can use a fingernail to lift it. The I/O board at the back of the P3 has a jumper at the top corner farthest from the rear panel above the large ribbon cable connector (see below).

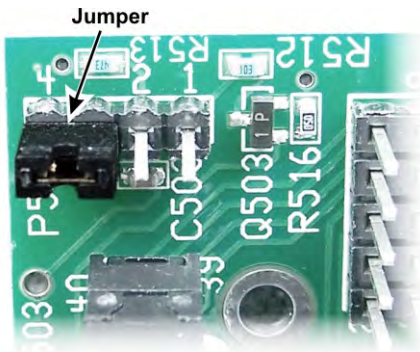

The jumper may be positioned on the pins as follows:

**Pins 3 & 4:** Normal operation of the **POWER** switch.

**Pins 2 & 3:** P3 turns on automatically when power is applied to the rear panel connector. P3 may be turned off and on using the **POWER** switch as long as power is applied.

**Pins 1 & 2:** **POWER** switch is disabled. P3 turns on automatically and remains on as long as power is applied to the rear panel connector.

Even if bypassed so power is on all the time, the **POWER** switch is still used in the event it is necessary to put the P3 in Boot Loader mode to force a firmware download. To cancel Boot Loader mode, remove power from the P3.

# Calibration Procedures

## Frequency Calibration

The P3 requires no calibration for normal panadapter operation. However if additional frequency accuracy is desired, you can perform the following calibration procedure.

**⚠ Turn the transceiver and P3 on and allow them to warm up for 30 minutes, minimum, before performing the calibration.**

- If the transceiver has a calibration procedure to correct its frequency errors, perform that procedure first.
- Using a well-calibrated signal generator or an on-the air carrier signal of known frequency, tune in the signal on the transceiver. An A.M. broadcast station can serve as a suitable test signal.
- Adjust the transceiver frequency to the known frequency of the test signal. Depending upon the modulation mode of the transceiver, the signal may not be audible.
- Set the P3 to tracking mode via MENU:FixTrack, set the span to minimum, and adjust the reference level and scale so you can easily see the signal.
- Hold **CENTER** twice to remove any center frequency offset that may have been introduced.
- Select *MENU:Ref Cal*, tap the **SELECT** knob, and adjust the frequency calibration until the carrier is centered horizontally on the display. If the required correction is more than a few hundred units, it may be that the I.F. frequency is set incorrectly. That can be adjusted via *MENU:Xcvr Def*.

## Amplitude Calibration

The P3 comes with a default amplitude calibration that works well with a K3 transceiver. Note: If your K3 was manufactured before September 2009, it must have the “I.F. Output Buffer Gain Modification” for the default value to be accurate (see the note at the top of page 4).

If you have an older K3 without the modification or you are using another type of transceiver, or if you’d simply like to optimize the calibration, you can perform the following calibration procedure.

You will need a signal generator with a calibrated output level. The recommended frequency is 7040 kHz with an output level of 50 microvolts (-73 dBm). The Elecraft XG2 signal generator will provide the recommended output and frequency.

Other power levels and frequencies within range of your transceiver may be used. You’ll need to make suitable adjustments to the frequencies and levels given in the following procedure.

- Connect the P3 IF IN to the transceiver’s i.f. output.
- If using a K3, connect the RS232 cable between the K3 and P3, turn the preamplifier OFF, the attenuator ON and be sure the sub receiver is not enabled.
- Connect the signal generator to the transceiver antenna input. If using a K3 with the KXV3 option, it is best to use the RX ANT IN connector to eliminate the possibility of damaging your signal generator if you accidentally put the K3 in transmit. If you use the main antenna connector and have the KAT3 option installed, put it in bypass by holding **ATU** until BYPASS appears on the LCD display.
- Set the signal generator for 7040 kHz at a signal level of 50µV (-73 dBm).
- Put the P3 in tracking mode via MENU:FixTrack, set the span to 100 kHz , and tune the transceiver to approximately 7015 kHz so the signal is centered on the right half of the display.
- Set the P3 Scale to maximum expansion (10 dB) and adjust the Ref Lvl to about -78 dBm in order to place the signal peak about half way up the screen. You may notice a slight variation in the peak signal level with small adjustments in the transceiver frequency as the signal moves from pixel to pixel on the screen. Adjust the frequency for maximum reading.

- Select *MENU:Lvl Cal*, tap the **SELECT** knob, and adjust the knob to place the signal peak at -73 dBm on the display. Note: the K3's RX ANT input has about 1 dB less loss than the ANT connector, so you may want to set the signal level at -72 dBm when using that input.

## Amplitude Calibration for Transverters

You can calibrate a receiving or transmitting converter, either the K3's internal K144XV or an external device connected to the K3.

If you plan to do the above calibration on an HF frequency, do that first since that calibration will affect the transverter calibration.



- Set up the P3, the signal generator, the transverter and the K3 in the manner described above to obtain a signal in the center of the right-hand side of the display and with its peak centered vertically.
- Select *MENU:XV Gain*, tap the **SELECT** knob, and adjust the knob to select the desired transverter band: 1-9. (You can enter separate calibration values for each transverter band by repeating this procedure for each band.)
- Tap the **SELECT** knob again, and adjust the knob to place the signal peak at the level corresponding to the output of your signal generator.

## Transmit Monitor (Tx Mon) Calibration



The transmit monitor sensor is factory calibrated with sufficient accuracy for most applications. If you have a well-calibrated power meter and want to have your P3 match its readings, you can adjust the P3 calibration as follows. A separate calibration value is stored for each of the three sensor types, so if you have more than one sensor adjusting the calibration of one will not affect the calibration of the others.

- Connect a high-quality dummy load to the sensor LOAD connector.
- In TXMonMenu select SensorCal and tap the knob to activate the adjustment.
- Transmit a CW signal through the sensor and adjust the P3 SELECT knob to match the power indicated on your external meter on the P3 PEP display.
- Exit the menu to store the new calibration value in memory.

# Menu Functions

Tap **MENU** and then turn the  **SELECT** knob to scroll through the following list of menu functions. Tap the  **SELECT** knob to select the displayed function.

## Basic P3 Menu

Entry	Default	Description
CenterEn	OFF	When OFF, the CENTER key does not adjust the center frequency when in tracking mode.
Cursors	Bar	Bar produces a full height translucent bar on the spectrum display. "U" produces a U-shaped cursor at the bottom of the spectrum display.
DispTest	off	Shows a test pattern with a color bar and the complete character set of each font. Tap <b>MENU</b> to exit.
FixMode	Half	Select what happens when the K3 VFO A is tuned off-screen in fixed-tune mode. "Full" or "Half" means automatically adjust the center frequency by one full screen or one half screen to keep VFO A within range. "Slide" means move the center frequency the minimum amount. "Static" means don't move the center frequency at all, that is, allow the cursor to move off screen.
FixTrack	Tracking mode	Toggle between fixed-tune mode and tracking mode.
Font	9 x 14	Changes the font size.
FN Erase	N/A	Resets a function key to its un-programmed state. Tap or hold the function key to be erased while this menu item is displayed.
Freeze	off	Freezes or un-freezes the current spectrum and waterfall display. This function is most useful when assigned to a function key, which toggles between the frozen and un-frozen state.
FW Rev	N/A	Displays the main firmware version number. It is not necessary to tap the  <b>SELECT</b> knob for this function.
Knob Tap	N/A	When assigned to a function key, duplicates the  <b>SELECT</b> knob's tap function.
Knob Hold	N/A	When assigned to a function key, duplicates the  <b>SELECT</b> knob's hold function.
LCD Brt	100	Adjusts the display brightness from 0-100.
LCD Test	off	Set all display pixels to white at full brightness.
Lvl Cal	-5.8	Calibrates the "transfer gain" (gain from antenna to IF OUT connector) of the transceiver (see page 33).
Lvl Lines	Dotted	Select the amplitude level graticule line type, dotted or solid.
Lvl Mode	dBm	Select the amplitude level display units, either dBm or S-units plus dB over S9.
MKRA zero	N/A	Resets marker A to the center of the screen.
MKRB zero	N/A	Resets marker B to the center of the screen.



Entry	Default	Description
NB En	off	Toggles the noise blanker on and off
NL Level	11	Sets the noise blanker level. 1 = least aggressive, 15 = most aggressive.
Peak	off	Toggles peak-hold mode on and off. This function is most useful when assigned to a function key.
Rate	10	Changes the display update rate in milliseconds. Although values down to zero may be entered, the minimum display period is actually limited by hardware.
Ref Cal	0	Calibrates the 60 MHz P3 reference clock frequency (Page 32).
Reset	N/A	Resets the P3.
RS232	38400	Change the baud rate in bits per second of the serial port that connects to a host computer. During firmware download (via the P3 Utility program), the baud rate is set automatically to 38400 baud, but it is then restored to the value selected in this menu entry.
SpanScale	REF LVL only	Specifies the way the P3 responds to changes in SPAN. “Off” means do not change REF_LVL or SCALE when SPAN is changed. “REF LVL only” means change the reference level to keep the noise level approximately constant. “REF LVL & SCALE” means also change SCALE to keep the level corresponding to the top of the screen at a constant level as well.
Span Set	N/A	Tap or hold a function key to assign a current SPAN to that key. Once assigned the function key can be used to set the span with a single key press. The key label shows the span in kHz.
SVGA menu	N/A	Only available if the P3SVGA option board is installed See <i>P3SVGA Option Menu</i> on the next page.
Sw Test	off	Toggle switch test mode on or off. When on, a special test screen is displayed that shows the state of each switch and the current encoder count. Tap the  <b>SELECT</b> knob twice to exit.
TXMon	N/A	Only available if the Transmit Monitor option is installed. See <i>Transmit Monitor Menu</i> on page 38.
VFO B	on	Turns the VFO B cursor on or off.
Waterfall	100	Changes the height of the waterfall window when the display is in waterfall mode.
Wfall Avg	off	Enables or disables application of averaging to the waterfall display
Wfall Clr	Default Colors	Selects either color or gray scale (no color).
WfallMkrs	off	Enables or disables markers on the waterfall display.
Xcvr Def	off	This key brings up a menu to define the “User” transceiver in the transceiver selection menu, Xcvr Sel. You can change the intermediate frequency (I.F.), the I.F. tuning direction (inverted or not), the transceiver’s command language, and the transceiver name.

Xcvr Sel	K3	Allows changing among a list of transceivers. For transceivers not listed, it also allows selecting a user-defined transceiver or simply choosing the I.F.
XV Gain	+25.0	Calibrate the gain of the transceiving converters (transverters) used with the K3 (see page 34). Stores separate values for each of the 9 transverter bands.
XV Invert	Inverted	Specify the tuning direction of the intermediate frequency bands used for transceiving converters. First select one of the 9 transverter bands, and then tap the  <b>SELECT</b> knob to choose “Inverted” or “Not Inverted” (see page 21).

## P3SVGA Option Menu

Entry	Default	Description
SVGA bias	2.7	Changes the waterfall color rendition on the external display (See <i>SVGA Waterfall Color Bias</i> on page 22).
SVGA data	Off	Enable/Disables data display on external display (see <i>Data Terminal Setup</i> on page 23)
SVGA en	On	Enable/disables the external display (see <i>SVGA Display On/Off</i> on page 22)
SVGA fill	Off	Fill space below spectrum line or leaves it open on the external display (see <i>Spectrum Display Fill</i> on page 22)
SVGA fntD	0	Sets font size in data window on the external display(see <i>Adjusting the Receive and Transmit Windows and Font Sizes</i> on page 23)
SVGA font	0	Sets font size on the external display except for the font used in the data window (see <i>SVGA Font Size</i> on page 22)
SVGA FW	N/A	Displays the SVGA firmware version.
SVGA res	1280x1024	Sets the resolution on the external display (see <i>Set Resolution</i> on page 22)
SVGA Ubmp	N/A	Saves screen bitmap to external device via keyboard USB connector (see <i>Screen Capture</i> on page 28)
SVGA Urst	N/A	Restores messages and macros saved to an external device (see <i>Test Message and Macro Save and Restore</i> on page 28).
SVGAUsav	N/A	Saves messages and macros to an external device (see <i>Test Message and Macro Save and Restore</i> on page 28).
SVGA WinR	4	Sets receive data window size on the external display (see <i>Adjusting the Receive and Transmit Windows and Font Sizes</i> on page 23).
SVGA WinT	3	Sets the transmit data window size on the external display (see <i>Adjusting the Receive and Transmit Windows and Font Sizes</i> on page 23).

## Transmit Monitor Menu

Entry	Default	Description
CW Split	Toggle	Switches between Sensor Split Enabled and Sensor Split Disabled. Allows viewing both CW rise times and CW fall times simultaneously.
Mtr En	Toggle	Turns the TX power and SWR meter on or off.
MtrScale	200W for 2 kW sensor 20W for 200W sensor	Sets the full scale value shown on the power display. When using a 2 kW sensor, full scale values of 20 W, 120 W, 200 W, 700 W, 1200 W or 2000 W may be selected. When using a 200 W sensor, full scale values of 2W, 12W, 20W, 70W, 120W or 200W may be selected.
Mod En	Toggle	Turns the modulation envelope display on or off.
ModScale	25	Horizontal sweep rate. Adjustable from 25 ms to 100 ms in steps of 5 ms.
SensorCal	500	Sensor Calibration. Adjusts from 360 to 650.
TX hang	400 ms	Transmit hang time in milliseconds.

## Troubleshooting

The most common symptoms and their causes are listed below.

**Can't turn power off.** The most likely cause is the power turn-on jumper located on I/O board is set incorrectly. See *Configuration* on page 31.

**"FAILED CHECKSUM" message appears in the "P3 BOOT LOADER" screen.** Main P3 firmware is not present or corrupted. Use P3 Utility to download new firmware. (Page.28).

**"DOWNLOAD FIRMWARE, READY FOR DOWNLOAD" message appears in the "P3 BOOT LOADER" screen.** Either cycle power to return to normal operation or use P3 Utility to download new firmware (Page. 28).

**Center frequency shows zero Hertz.** This is normal if the transceiver is not connected to the P3's RS232 port. If the transceiver is a K3 that is connected via RS232, check for a loose or defective serial cable.

**P3 displays the wrong center frequency.** Hold the **CENTER** key to select the center frequency adjustment and then hold it again to re-tune the P3 center frequency to the K3 VFO A frequency.

**Amplitude display is in error by about 3 dB.** Check that the rear-panel IF OUT switch is in the correct position.

**Intermittent clicking sound heard.** The P3 includes a relay that automatically bypasses the input amplifier when very strong signals overload the front end. Try turning off the transceiver's preamplifier or turning on its attenuator.

# Parameter Initialization

Menu parameters are stored in non-volatile EEPROM memory. It is possible, though rare, for parameters to become altered in such a way as to prevent the firmware from running correctly. If you suspect this, you can reinitialize parameters to defaults.

**i** **Reinitializing the parameters will erase any Function key assignments you have made and return all of the MENU entries to the default values shown in page 35.**

- Write down your function (FN) key assignments and MENU parameters you have set.
- Turn the P3 OFF (tap the P3's **POWER** switch, not by turning off your power supply). If the power-on jumper on the I/O board is in the "always-on" position (page 31), then skip this step.
- While holding in the **LABELS** key, tap the **POWER** switch to turn the P3 on. After about 2 seconds, let go of the **LABELS** key. You should now see **CONFIGURATION RESET** on the LCD screen.
- Re-enter all the menu parameters and function key assignments you wrote down.
- See if the original problem has been resolved.

# Theory of Operation

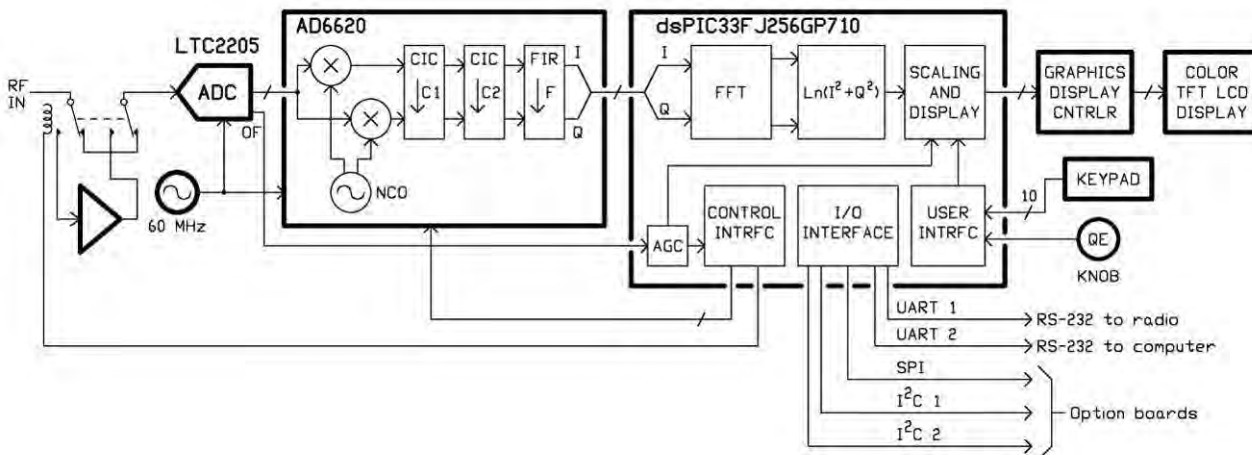

The P3 is a true software-defined receiver — the input goes through an amplifier directly to a 60 Msample/sec analog-to-digital converter (ADC), with all tuning, signal processing and the user interface under software control. The Analog Devices AD6620 digital down-converter includes a numerically-controlled oscillator (NCO) which acts as a local oscillator and a pair of multipliers that act as a quadrature mixer that down-convert a band of frequencies to a pair of baseband in-phase and quadrature (I/Q) signals. Those signals then pass through three decimating low-pass filters to generate a lower-bandwidth, lower-sample-rate I/Q signal that is passed to a Microchip dsPIC digital signal processor/controller.

The dsPIC further processes the signal for presentation on the 480x272-pixel color TFT LCD display. The "circuitry" shown inside the processor box in the block diagram is actually implemented as software routines. The FFT is the fast Fourier transform, which is a software version of a hardware spectrum analyzer. It reads the incoming signal and calculates the frequency spectrum. Further software routines calculate the power of the spectrum, take the logarithm, and then scale and offset the result so that it reads correctly in dBm on the display.

The dsPIC also acts as a controller for the rest of the circuitry. For example, whenever the user changes the span, new decimation and filter values are calculated and loaded into the AD6620 digital down-converter and new constants are calculated for interpolating the FFT output for display. In that way, the optimum sample rate is used for any span, which optimizes the display update speed and ensures that each horizontal pixel on the display always represents a distinct frequency, with minimum bleed-over between pixels.

One firmware task is to maintain communications with the K3 transceiver over one of the RS232 ports. A special P3-specific command set has been implemented in the K3 to maximize communications efficiency. In addition, a special P3-K3 communications protocol was set up to ensure that the P3 gets the information it needs when it needs it, so that the P3 acts as a fully-integrated extension of the K3.

In addition to two UART (universal asynchronous receiver-transmitter) ports for the two RS232 connectors, an SPI (serial peripheral interface) and two I<sup>2</sup>C (inter-integrated circuit) interfaces are provided for option modules. Those interfaces, plus power supplies and other signals, are carried on a 40-wire ribbon cable between the main front-panel processor board and the rear-panel I/O board. Option boards are stacked on the I/O board, with the 40-pin connectors daisy-chained together, acting like a bus or backplane. In that way, more options may be included in the future simply by stacking more boards.

For best efficiency, the +3.3 V and +5 V internal power supplies are supplied by a pair of switching DC-DC converters from the +12 VDC input. The input power is approximately independent of the voltage, which means the lower the input voltage the higher the current. While the P3 will typically work with input voltages of less than 8 V, the current may exceed the 0.5 A specification at that voltage.



**P3 Rear Panel Assembly – E850431**

ILLUSTRATION	DESCRIPTION	QTY.	ELECRAFT PART NO.
	Rear Panel	1	E100365
	Hole Cover	1	E100396



**P3 Misc Bag - E850433**

**P3 Chassis Hardware – E850409**

ILLUSTRATION	DESCRIPTION	QTY.	ELECRAFT PART NO.
	2-D Fastener	8	E100078
	L-Bracket	4	E700073
	Jackscrew Nut, 4-40	4	E700078
	Screw, Pan Head, Zinc, 4-40 7/16" (11 mm)	6	E700032
	Nut, Hex, 4-40	6	E700011
	Lock Washer, Inside Tooth, #4	10	E700010
	Screw, Pan Head, Black, 4-40 3/16" (4.8 mm)	10	E700015
	Screw, Flat Head, Black 3/16" (4.8 mm),	22	E700025
	Lock Washer, BNC, Inside Tooth 9/16" (14.3 mm)	4	E850433
	Nut, BNC, 9/16" (14.3 mm)	2	E700059
	Tilt Stand with Front and Rear Feet	1 set	E980129
Continued on next page			

ILLUSTRATION	DESCRIPTION	QTY.	ELECRAFT PART NO.
	Knob	1	E980089

***P3 Front Panel Hardware Envelope – E850432***

ILLUSTRATION	DESCRIPTION	QTY.	ELECRAFT PART NO.
	Screw, Black, Pan Head, 2-56 1/4" (6.4 mm)	8	E700124
	Threaded Standoff, 2-56 5/16" (8 mm)	4	E700122
	Lock Washer, Split Ring, #2	8	E700123





***P3 Cables – E850434***

ILLUSTRATION	DESCRIPTION	QTY.	ELECRAFT PART NO.
	Power Cable 2.1 mm Barrel – RCA	1	E850427
	Ribbon Cable, 40 cond. 18" (46 cm)	1	E850438
	RF Cable, BNC – BNC, 36" (91.5 cm)	1	E980170
	TMP Cable, 10" (25.4 cm)	1	E850338
	DE9 Cable M-F, 36" (91.5 cm)	1	E980169
	Retaining Clip	1	E980228

**Note:** Some cables may have packages showing the original vendor's part number instead of the Elecraft part number.

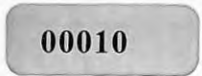





## P3 PCB Box – E850436

ILLUSTRATION	DESCRIPTION	QTY.	ELECRAFT PART NO.
	Serial Number Label (in protective envelope)	1	E850437
	P3 Front Panel Board with LCD and Switch Matrix.  <b>⚠ IMPORTANT:</b>  <b>Components on this board are easily damaged with careless handling. Leave it in its protective wrapping until instructed to remove it.</b>  <b>One pin has been cut on the 40-pin connector. This is intentional.</b>	1	E850426
	P3 Rear Panel I/O Board.  <b>Note that one pin has been removed from the 40-pin connector. This is intentional.</b>	1	E850386
	Header Shorting block, 2 pin (supplied mounted on the Rear Panel I/O board.)	1	E620055
	P3 Rear Panel RF Board	1	E850396



## P3SVGA Parts

If you purchased the P3SVGA option with your kit, the following parts are included.



ILLUSTRATION	DESCRIPTION	QTY.	ELECRAFT PART NO.
	<p>P3SVGA Circuit Board Assembly</p> <p> <i>ESD Sensitive.</i></p>	1	E850482
	<p>Jackscrew Nut, 4-40 (may be mounted on the Circuit Board Assembly Connector)</p>	2	E700078
	<p>Lock Washer, Inside Tooth, #4 (may be mounted on the Circuit Board Assembly Connector)</p>	2	E700010

## Transmit Monitor (Tx Mon) Parts

If you purchased the Transmit Monitor option with your kit, the following parts are included.

ILLUSTRATION	DESCRIPTION	QTY	ELECRAFT PART NO.
	TXMON PCB Assy <b>⚠ ESD Sensitive</b>	1	E850387
	W2 Sensor Cable RJ8 6' (183 cm)	1	E850638
	Coupler (power and frequency range chosen at time of order).	1	DCHF-200 DCHF-2000 DCV/U-200

### *P3TXMON Hardware Bag E850721*

ILLUSTRATION	DESCRIPTION	QTY	ELECRAFT PART NO.
	Screw, 1/4" (6.4 mm) Zinc, Pan Head	4	E700005
	Lock Washer, Split Ring #4	4	E700004
	Standoff, 5/8" (15.8 mm) 4-40 Hex	2	E700060

# Kit Assembly Instructions

## Preventing Electrostatic Discharge Damage

Sensitive components in your P3 are may be damaged by Electrostatic Discharge (ESD) in any location or climate unless you take specific steps to prevent such damage. Many components can be damaged by static discharges of only a few volts: far too little for you to notice.

ESD damage may not be apparent at first. The damaged components may not fail completely. Instead, the damage may result in below-normal performance for an extended period of time before you experience a total failure.

We strongly recommend you take the following anti-static precautions (listed in order of importance) to ensure there is no voltage difference between the components and any object that touches them:

- Leave ESD-sensitive parts in their anti-static packaging until you install them. The packaging may be a special plastic bag that allow static charges to flow harmlessly over their surface, or the component's leads may be inserted in conductive foam that keep them at the same potential. Parts which are especially ESD-sensitive are identified in the parts list and in the assembly procedures.
- Wear a conductive wrist strap with a series 1-megohm resistor that will constantly drain off any static charge that accumulates on your body. If you do not have a wrist strap, touch a ground briefly before touching any sensitive parts to discharge your body. Do this frequently while you are working. You can collect a destructive static charge on your body just sitting at the work bench.

### **WARNING**

**DO NOT attach a ground directly to yourself without a current-limiting resistor as this poses a serious shock hazard. A wrist strap must include a 1-megohm resistor to limit the current flow. If you choose to touch an unpainted, metal ground to discharge yourself, do it only when you are not touching any live circuits with any part of your body.**

- Use a grounded anti-static mat on your work bench.
- If you choose to use a soldering iron to work on your P3 for any reason, be sure your iron has an ESD-safe grounded tip tied to the same common ground used by your mat or wrist strap.

## Tools Required

1. #0 and #1 size Phillips screwdrivers. Use the screwdriver that best fits the screw in each step. To avoid damaging screws and nuts, a power screwdriver is *not* recommended.
2. Needle-nose pliers.
3. A 3/16" nut driver is handy for removing and replacing the jack screw nuts on the rear panel connector but do not over tighten when replacing. A nut driver can easily exert enough torque to twist the hex section off of the screw and ruin it.

The following tools are strongly recommended:

1. ESD wrist strap.
2. Static dissipating work pad.

## Assembly Procedure

### Overview of the Kit

The circuit boards are mounted on the front and rear panels and interconnected by cables as shown in Figure 1. The enclosure uses Elecraft's 2D fasteners at the corners of the panels which allow removing any combination of panels to gain access to the interior.

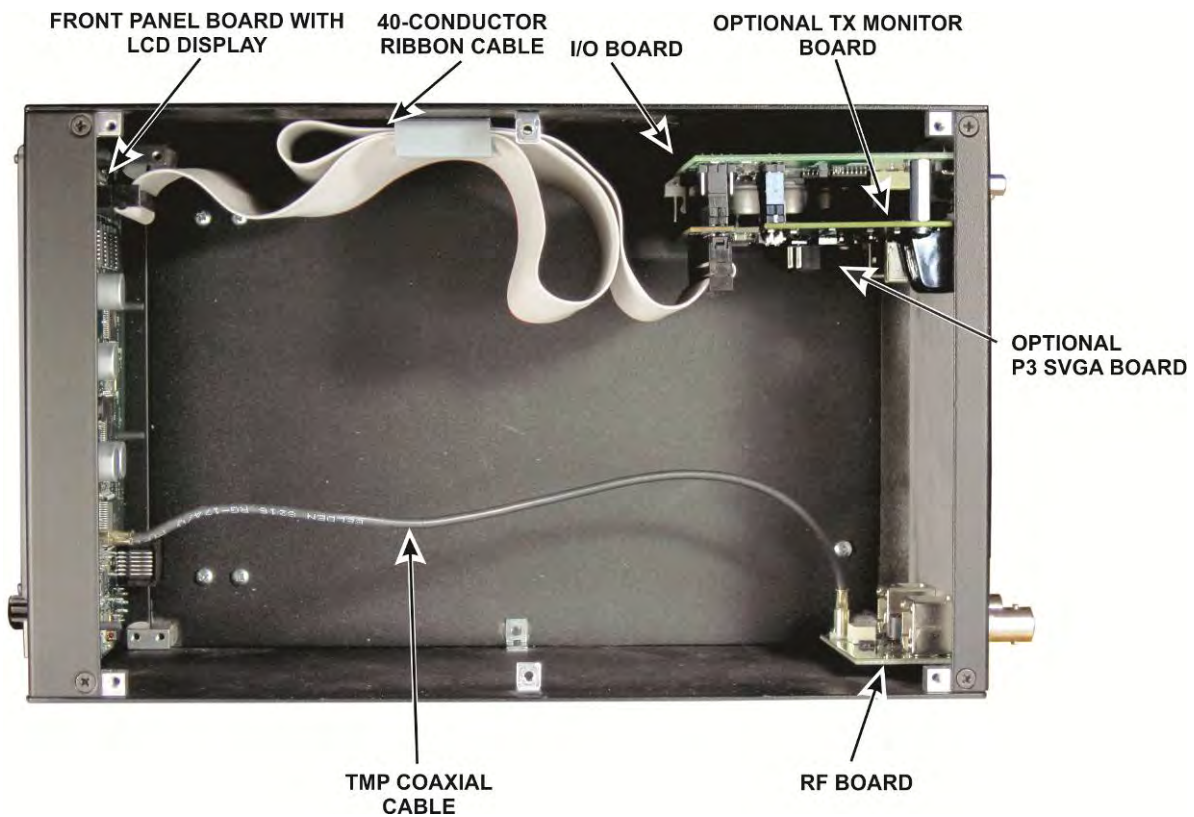

Figure 1 Assembled P3 with Top Cover Removed.

☐ Before starting construction, do a complete inventory, comparing the parts in your kit with the parts list beginning on 41, to familiarize yourself with all of the parts and to ensure the kit is complete, **but do not unwrap the front panel display board until instructed to do so in the assembly procedure.** If any parts are missing, contact Elecraft for a replacement (see, *Customer Service and Support* on page 8). Recommend you also keep the printed circuit board assemblies in their anti-static packaging until you are instructed to remove them.

### Front Panel Assembly

**⚠ CAUTION: The PC Boards are ESD-sensitive. Wear an ESD-safe wrist strap or touch a metallic ground regularly while handling the boards or at any time while working inside the P3. See *Preventing Electrostatic Discharge Damage* on page 47 for more information.**

☐ Carefully remove the front panel display board from its anti-static packaging, taking care not to damage the transformers or other components (Figure 2) or to allow the display panel to fall out of the soft rubber switch matrix (Figure 3). You may notice that one of the pins on 40-pin connector P200 has been cut off. That is intentional.

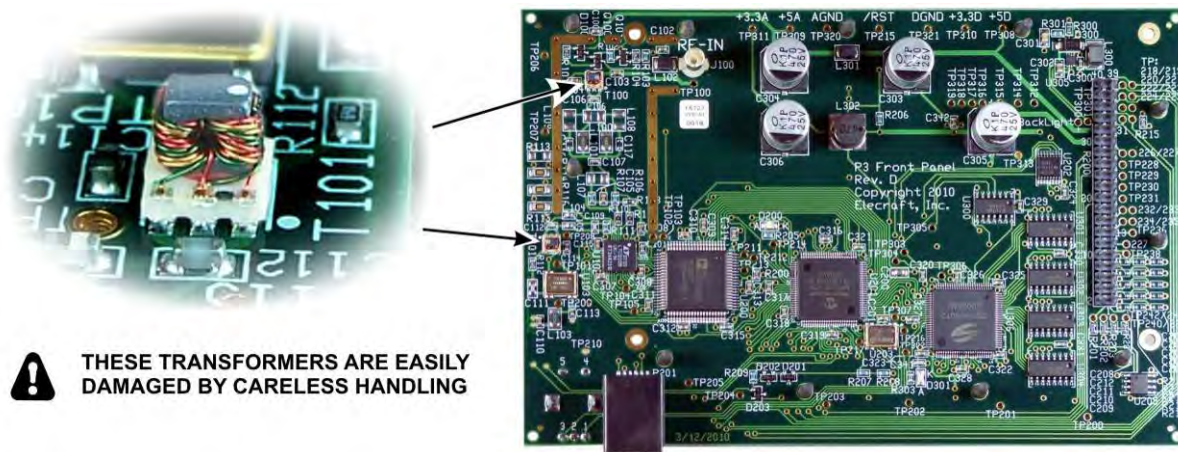

Figure 2. Front Panel Display Board Component Side.

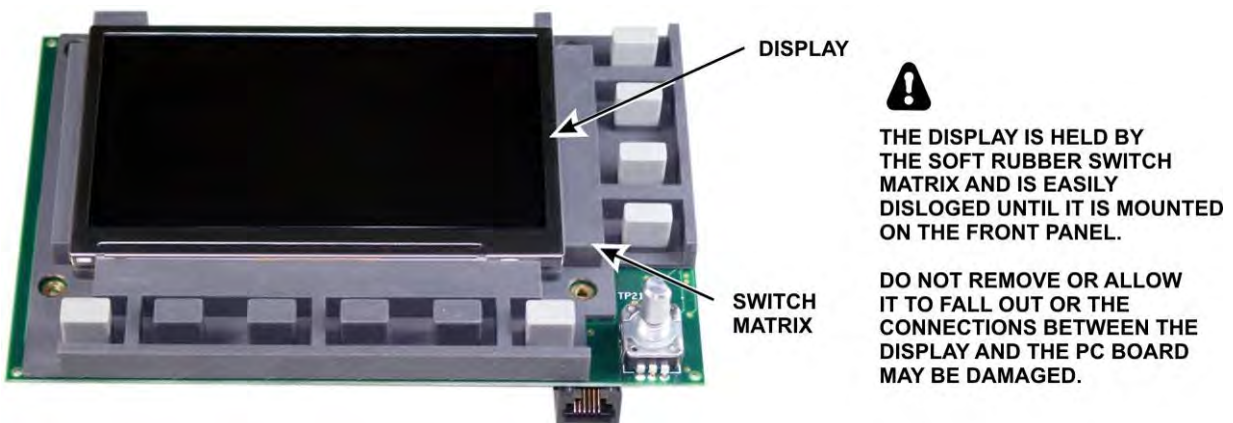

Figure 3. Display Panel in Front Panel Board.

☐ Inspect the display panel to ensure it is seated flat in the matrix as shown. Press it gently in place as needed but avoid touching the black surface and leaving fingerprints. Take care not to pull the display free as you may

damage the connections to the printed circuit board behind it. If you ever need to remove the display panel from the board, refer to *Replacing the LCD Display* on page 66 for detailed instructions.

- Mount four 2-56 5/16" (7.9 mm) standoffs on the front panel display board as shown in Figure 4. Be sure to place one lock washer between the standoff and the pc board as shown. This lock washer is important to establish the proper height of the standoff.

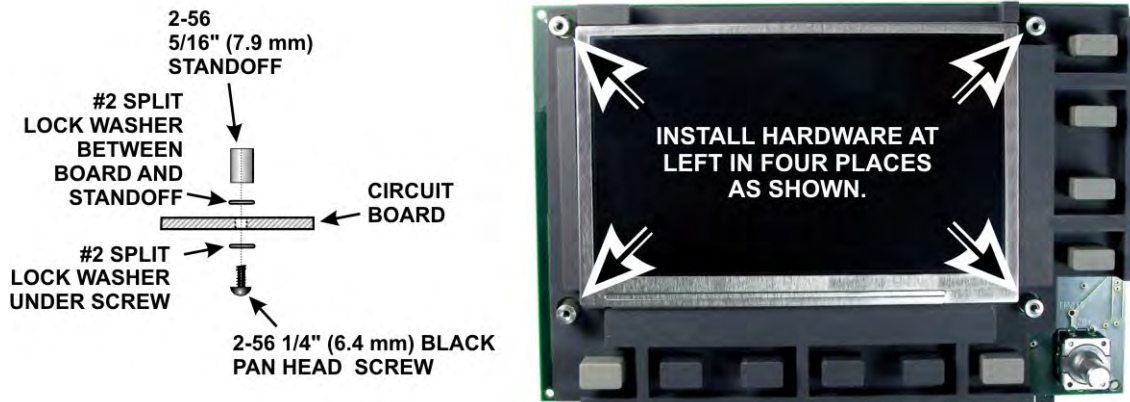

Figure 4. Mounting Standoffs on Front Panel Board.

- Locate the front panel. There are holes at each corner of the top and bottom flange and four holes around the opening for the display. The inside surface of the panel was masked during painting to ensure a small area of clean metal around each hole. Check each hole to ensure there was no tape left and the metal is clean and visible. This is important to ensure good grounding between the panels making up the cabinet.
- Remove the plastic display bezel from its protective wrapping and inspect it for dirt and dust, especially on the flat side that will face the display panel. Use a soft cloth if necessary to remove any objects clinging to the plastic. Similarly, inspect and clean the face of the display. If either requires further cleaning see *Cleaning the LCD Bezel* on page 65.
- Look closely at the edge of the bezel and note that the edge is slightly beveled on one side. This side will face away from the front panel.

□ Position the display board behind the front panel so all four standoffs line up with the holes in the panel. Be sure the buttons all pass through their respective holes in the panel. Place the plastic bezel over the display so its holes line up. Be sure the flat side of the bezel is toward the front panel and the side with the beveled edges is facing away from the panel (see Figure 5). Secure the bezel with four 2-56 1/4" (6.4mm) black pan head screws. Do not use lock washers. **Do not over-tighten the screws. You can distort or break the bezel.**



Figure 5. Bezel Mounted on Front Panel.

□ Check to ensure the knob has its spring insert in place, then press it onto the shaft. Be sure the flat on the shaft is aligned with the flat surface in the knob (see Figure 6). The control has a built-in switch so do not be surprised to hear a click when you press the knob onto the shaft. The knob will stand above the surface of the front panel to allow room for the knob to move when operating the switch. Also, some side-to-side movement of the knob is normal in a control of this type with a built in switch.

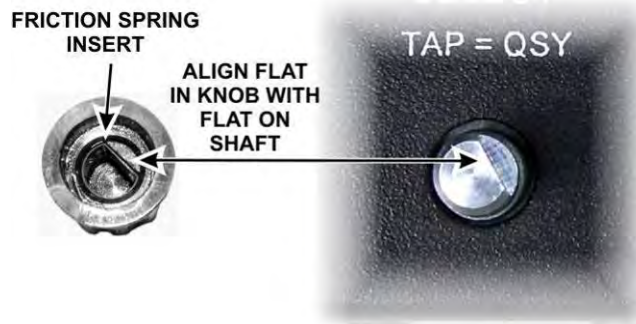

Figure 6. Installing the Knob.



Mount a 2D fastener at the top of the front panel assembly as shown in Figure 7. Do not use a lock washer. The 2D fasteners must always be oriented so the wide side of the fastener is toward the outside as shown. Tighten the fastener only enough to hold it in place. You will be loosening and adjusting all of the enclosure screws later as you finish the assembly and adjust the fit of all the panels.

**⚠ IMPORTANT: All of the 2D fasteners must be installed with the widest shoulder toward the outside. The enclosure screws on the top and sides use flat head screws while those on the bottom use pan head (rounded top) screws.**

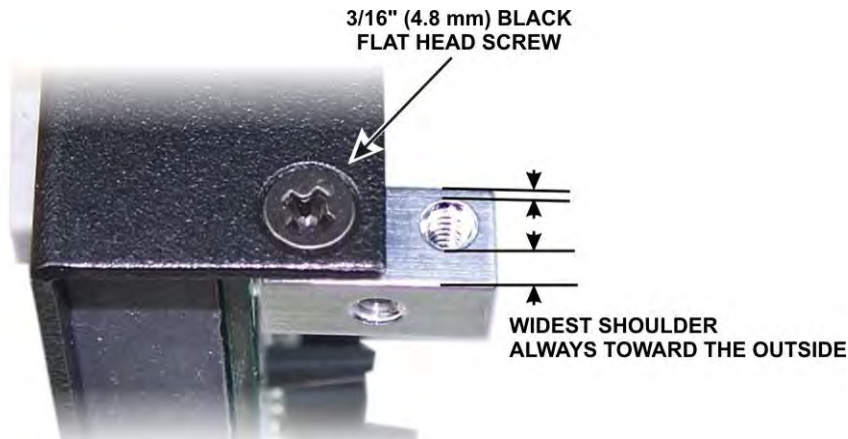

Figure 7. Installing 2D Fasteners.

Mount three more 2D fasteners on the front panel, one at each corner of the top and bottom flanges. Be sure to use pan (rounded) head screws in the bottom two holes.

Set the front panel assembly aside in a safe place.

### *Top and Bottom Covers*

Locate the top and bottom covers. Both covers have six holes for screws along the edges. The bottom cover has an additional six holes for the feet; four holes near the front end and two holes near the back. Also the bottom cover holes are *not* counter-sunk for flat-head screws.

At the back end of the bottom cover (with just two holes for feet) install a foot in each hole as shown in Figure 8. Be sure the feet are mounted on the bottom (fully-painted) side of the bottom cover.



Figure 8. Installing Rear Feet.

**INSTALLATION HINT:** Put the washer and screw in the foot opening and press your finger over the opening until the threads on the nut are caught by the screw. It may help to turn the cover over so gravity helps. Once the nut is started pull the foot away from the bottom cover while tightening the screw. The friction of the washer against the bushing inside the foot will keep the nut from turning as you tighten.

At the front end of the bottom cover, install the two feet and tilt stand as shown in Figure 9. Place the tilt stand with the ends inserted into the holes in the feet as shown before attaching the feet to the bottom cover. Use 4-40 7/16" (11 mm) zinc pan head screws with inside tooth lock washers and nuts just as you did for the rear feet.



Figure 9. Installing the Tilt Stand.

At the mid-point along each side of the bottom and top covers is a screw hole. Mount the four angle brackets in these holes as shown in Figure 10. Be sure all six holes of each cover have clean metal on the *inside* surface. **Do not remove paint on the outside surface!** Be sure to use pan head screws on the bottom cover brackets and flat head screws on the top cover brackets. The holes in the top cover are counter sunk for the flat head screws. Check to ensure the brackets are oriented as shown. If you install the bracket backwards the case parts will not fit correctly.



Figure 10. Installing Angle Brackets on the Covers.

Set the top and bottom covers aside in a safe place.

## Back Cover

- Locate the back cover. Check the area on the inside of the cover around each of the holes to ensure bare metal will contact the fasteners and connectors.
- The holes marked SENSOR, KEYBOARD, EXT. DISPLAY and AUX DATA are not used unless you purchased the optional P3SVGA and Tx Monitor modules. A plastic cover is provided for any holes that are not used at this time. It can be removed in the future should you decide to add either option. If you have both the P3SVGA and Tx Monitor options, skip the following steps and go directly to *Attaching the Serial Number Label* on page 55.
- Locate the hole cover. It is a transparent strip on a paper backing with adhesive that fits over the Sensor, Keyboard, Ext Display and Aux data holes on the back cover. Do not break the strip on the perforations. They are provided to allow you to easily remove individual sections as needed later. Remove the backing paper and place the strip on the inside surface of the back cover, aligned so the two round holes are over the corresponding holes above and below the EXT. DISPLAY connector opening in the cover and press it in place (see Figure 11). There is no adhesive over the areas that cover the openings so dust and dirt will not adhere to it.



Figure 11. Installing the Hole Cover.

Place a straight edge along the scored line on the hole cover and peel away the unwanted parts, depending upon which options you are installing. Figure 12 shows how to remove the covers from the KEYBOARD, EXT. DISPLAY and AUX DATA connector openings to install the P3SVGA option.

**⚠ If you have the TX Monitor option but not the P3SVGA, move the straight edge down below the scored line and remove only the top part of the cover over the SENSOR hole.**

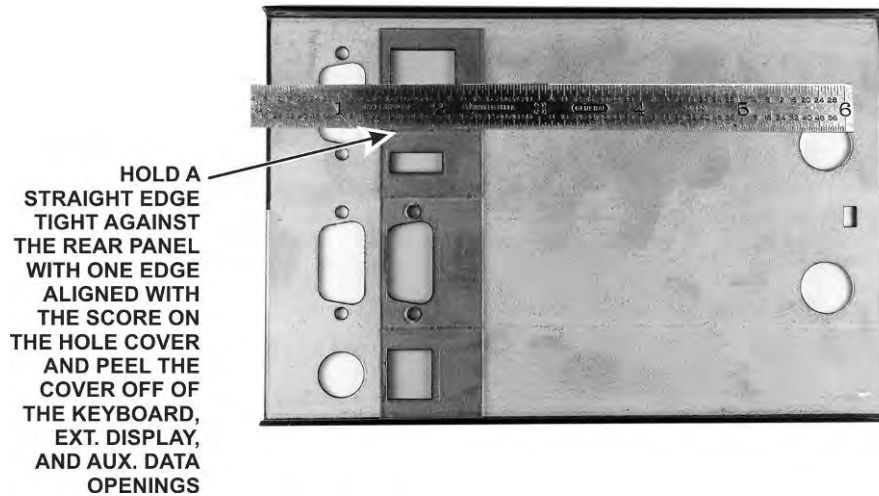

Figure 12. Preparing the Hole Cover to Install the P3SVGA Board.

### *Attaching the Serial Number Label*

Remove the protective backing from the Serial Number label and carefully position it on the outside of the rear cover as shown in Figure 13.

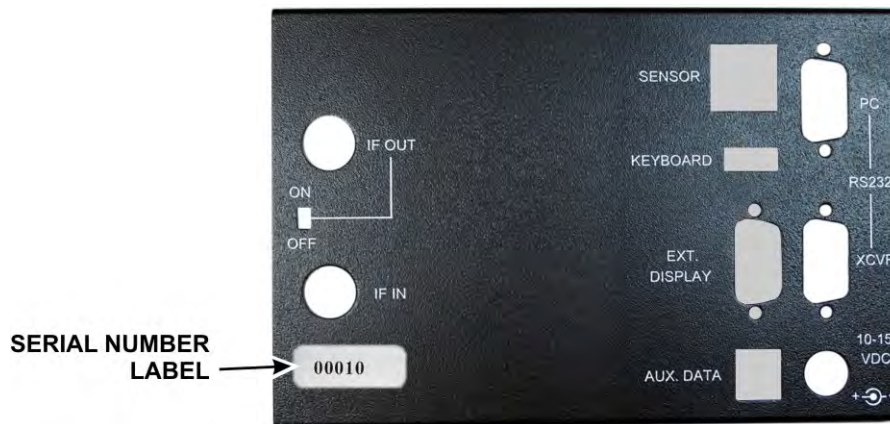

Figure 13. Attaching the Serial Number Label.

Mount a 2D fastener in the screw holes in the back cover top and bottom flanges just as you did for the front cover (see Figure 7 on page 52), using flat head screws in the counter-sunk holes on the top flange and pan head screws on the bottom flange. Be sure each fastener is oriented correctly with the widest shoulder toward the outside edge of the panel as shown in the figure.

□ Remove the I/O printed circuit assembly from its anti-static packaging and check to see if either of the two multi-pin connectors have jack screw nuts installed (see Figure 14). These are the nuts the jack screws on the connector shells screw into to secure them. If either connector has jack screw nuts installed, remove them.

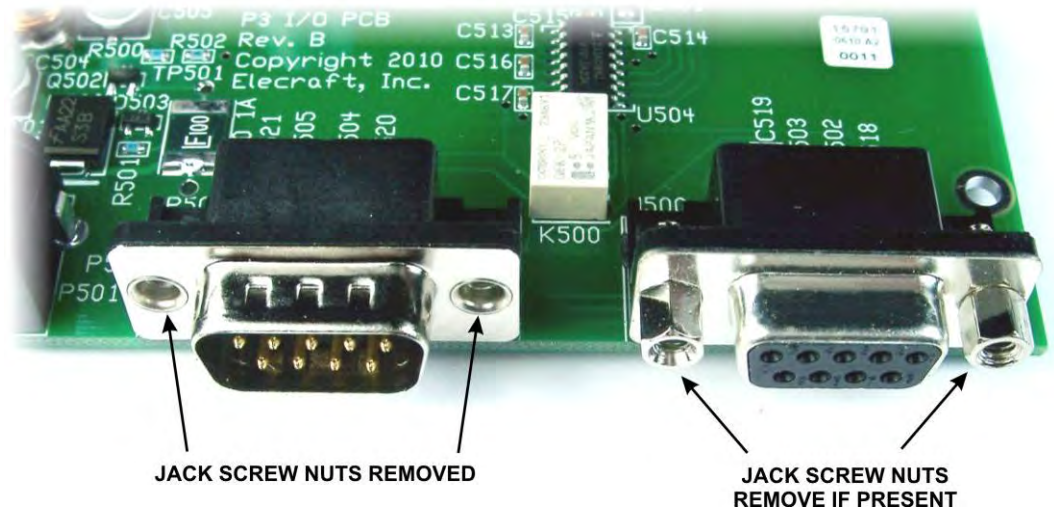

Figure 14. Preparing the I/O Board for Installation.

□ If you have the P3SVGA board to install at this time, check the connector and remove the jackscrew nuts if present, just as you did for the I/O board connectors (Figure 14). Mount the P3SVGA board on the I/O board as shown in Figure 15. Be sure the connectors are aligned so that all pins engage. To avoid over-stressing the boards, place the I/O board on a firm surface or support it with your fingers. You may need to rock the P3SVGA board slightly while pressing down to “walk” the pins into the connector/

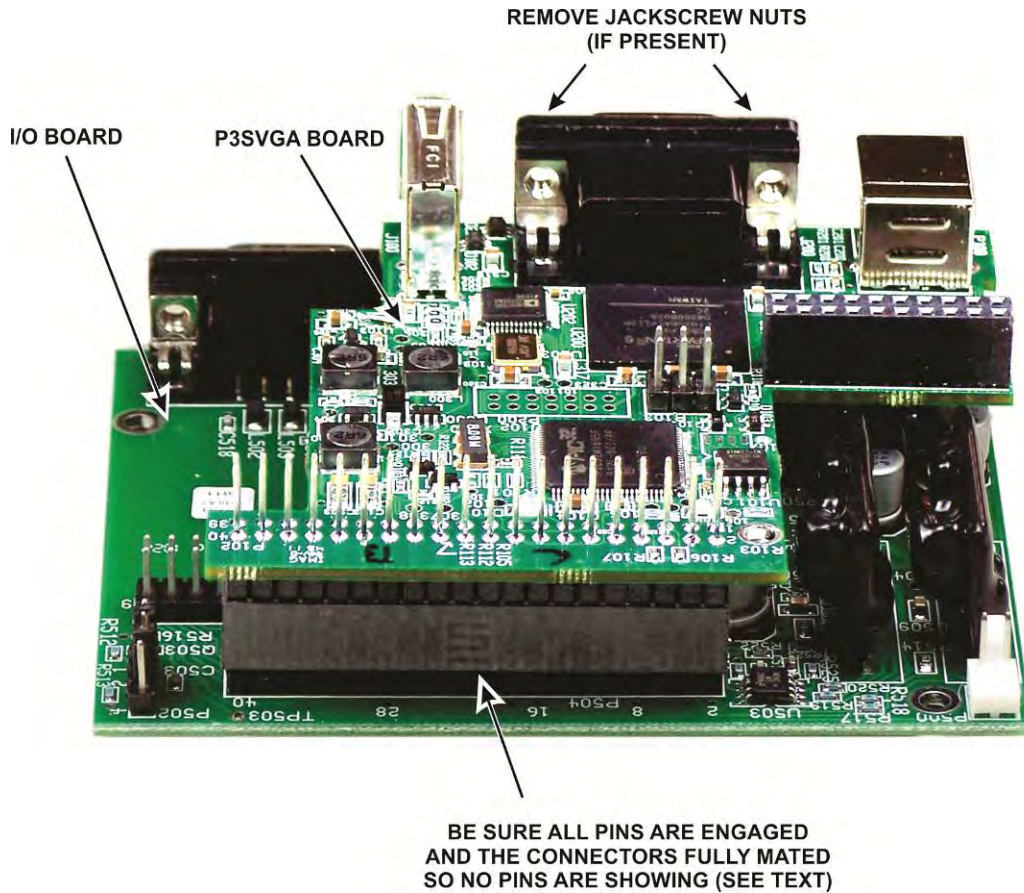

Figure 15. Mating the P3SVGA and I/O Boards.

- If you have the TX Monitor option, install it as follows:
  - Mount the two standoffs supplied with the option on the I/O board as shown in Figure 16.

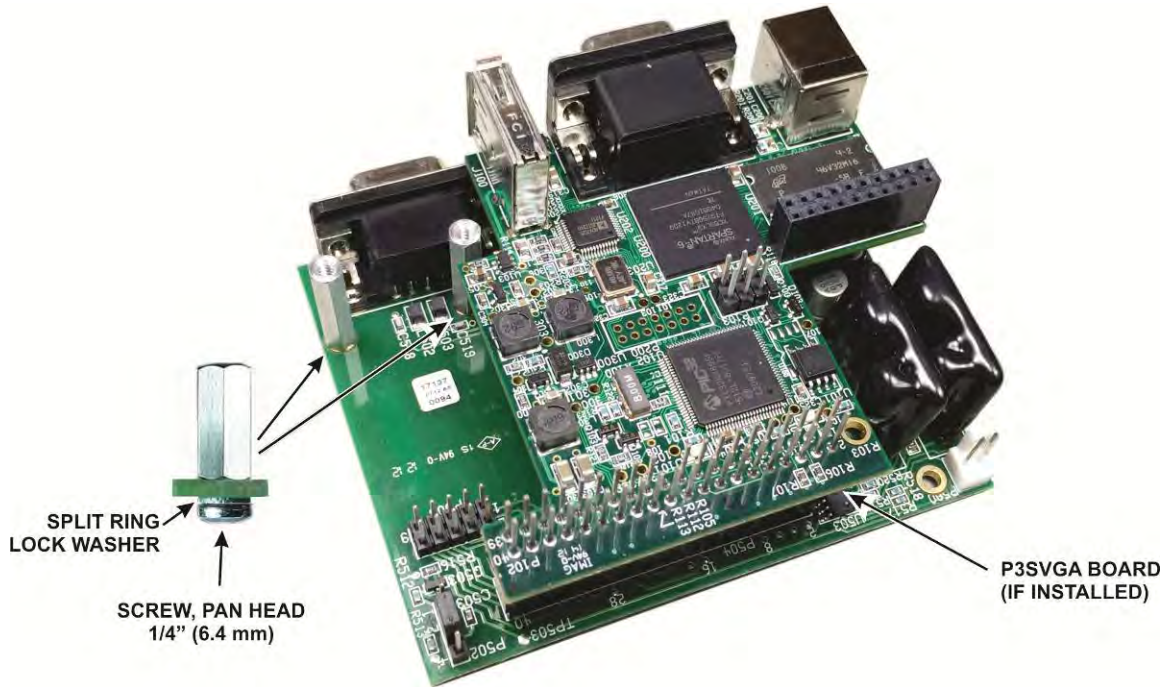

Figure 16. Mounting Tx Monitor Standoffs on the I/O Board.

- Mount Tx Monitor board on the I/O board as shown in Figure 17.

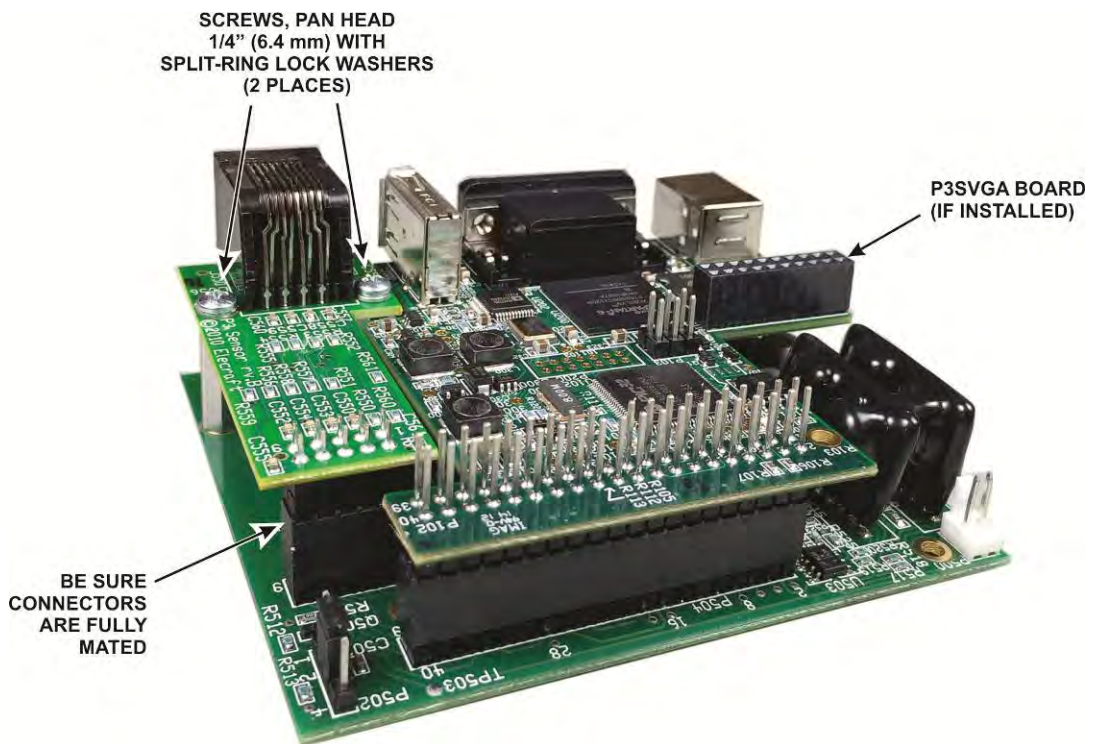

Figure 17. Mounting the Tx Monitor Board on the I/O Board.

## Installing the I/O Board Assembly

□ Mount the I/O board on the rear panel with the connectors in the RS232 PC and XCVR holes as shown in Figure 18. It is held in place by the jack screw nuts as shown.

**⚠ CAUTION: Do not over-tighten the jack screw nuts. It is possible to twist the hex nut section off of the threaded section with too much torque, especially if you are using a wrench to tighten them.**

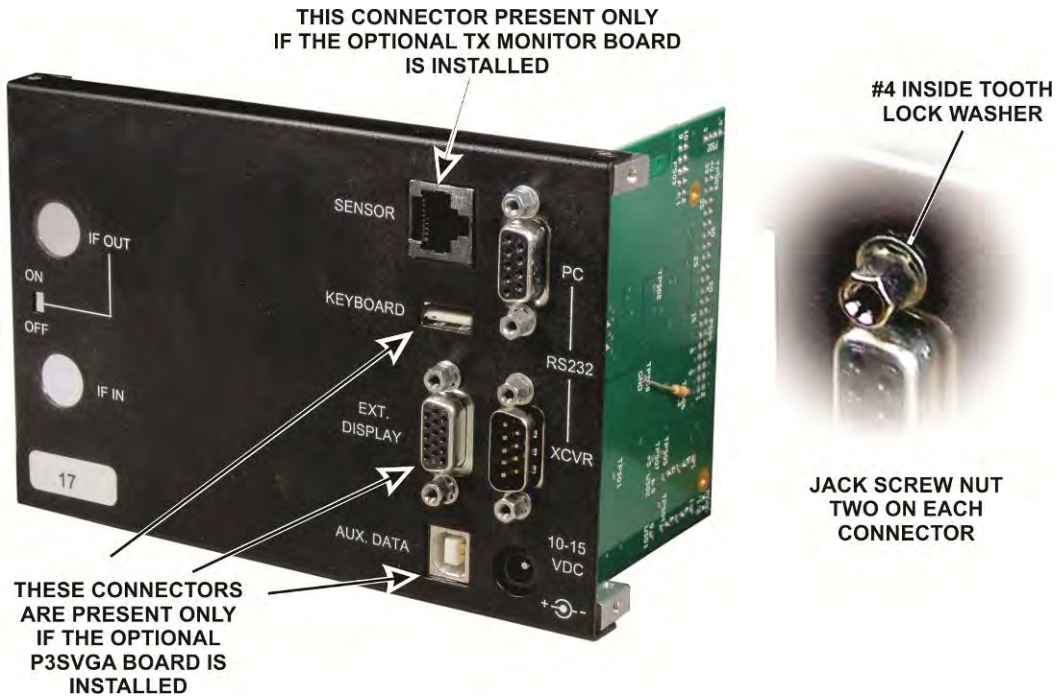

Figure 18. I/O Board Installed.



## Installing the RF Board

☐ Locate the RF Board, the four 7/16" (14.3 mm) inside tooth lock washers and the two 7/16" (14.3 mm) nuts.

☐ Mount the board on the rear panel as shown in Figure 19. Be sure two lock washers are between the BNC connectors and the inside surface of the rear panel and two lock washers are between the nuts and the rear panel as shown. **Tighten the nuts gently until they slightly compress the lock washers. That will hold the assembly securely in place. Over-tightening may place unnecessary strain on the RF board.**

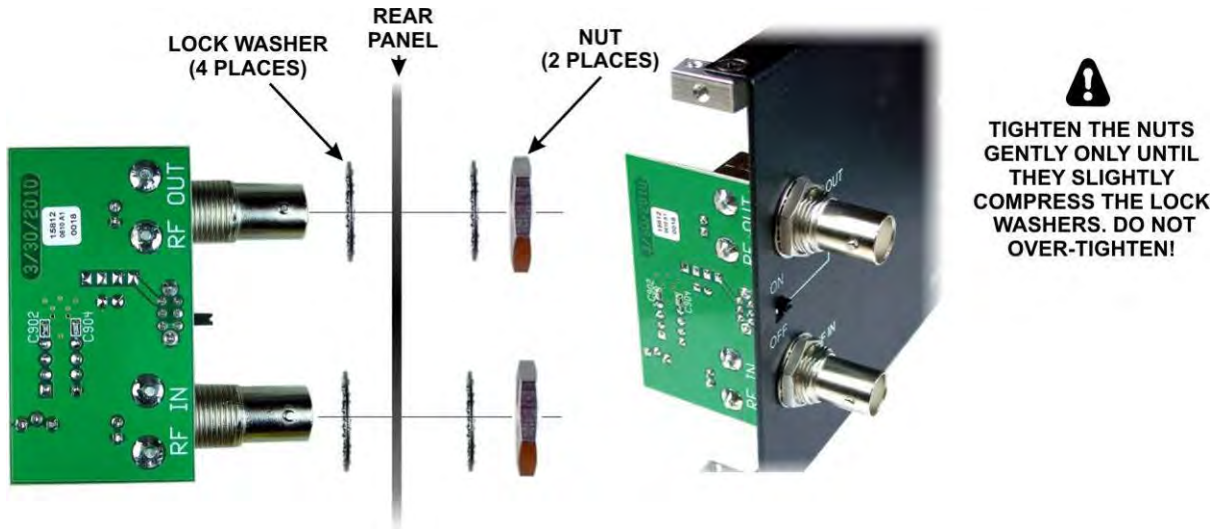

Figure 19. RF Board Installation.

### ⚠ NOTES:

1. The RF board connectors may be labeled RF OUT and RF IN while the rear panel is labeled IF OUT and IF IN. That is normal.
2. The SENSOR connector opening in the rear panel is for future use.

## Mounting the Rear Panel Assembly

Mount the rear panel assembly to the end of the bottom cover that has the two round feet using a 3/16" (4.8 mm) pan head screw into each 2D fastener. If the optional P3SVGA board is installed, note that a notch in the bottom of the board clears the screw for the rear foot (see Figure 20).

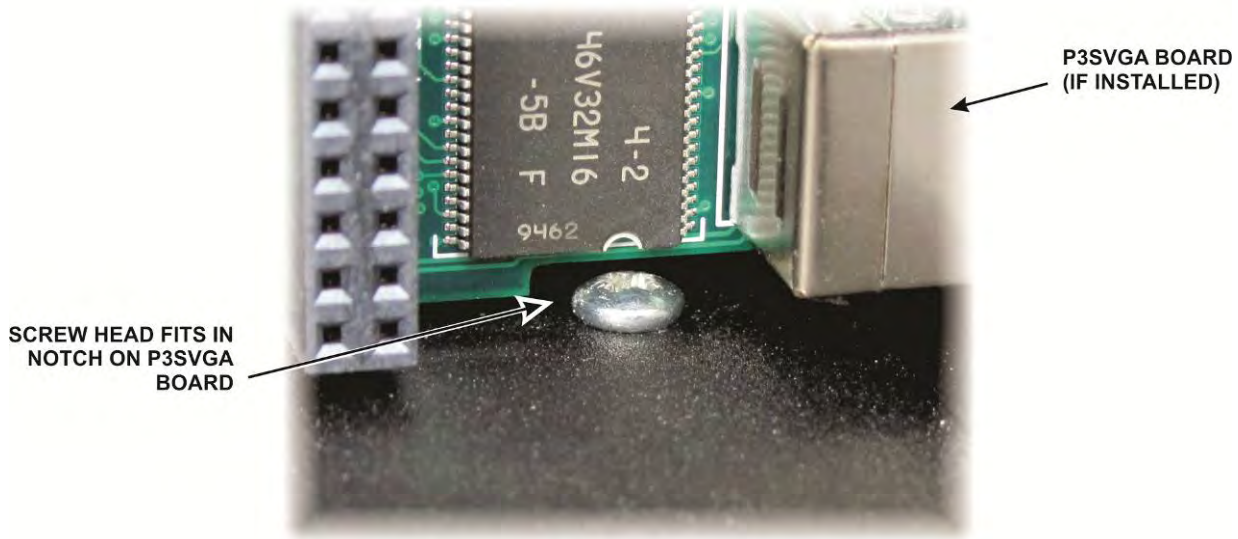

Figure 20. Clearance Notch in P3SVGA board.

**⚠ CAUTION:** Severe damage to your P3 may occur if the 40-conductor ribbon cable is not oriented correctly and properly mated to the connectors as described in the following steps.

## Final Assembly

Retrieve the front panel assembly and locate the 40-conductor ribbon cable. Note that one edge of the ribbon cable is colored, usually brown or red.

Plug the ribbon cable into P200 on the display board with the colored edge of the cable at Pin 1 (the bottom of the connector when the board is oriented normally). Be sure the connectors are properly aligned so that all pins engage and they are fully mated as shown in Figure 21). One pin has been removed from the connector on the pc board and the corresponding hole in the cable connector is plugged to help ensure they are properly aligned end-to-end but check carefully to ensure the connector is mated to both rows of pins.

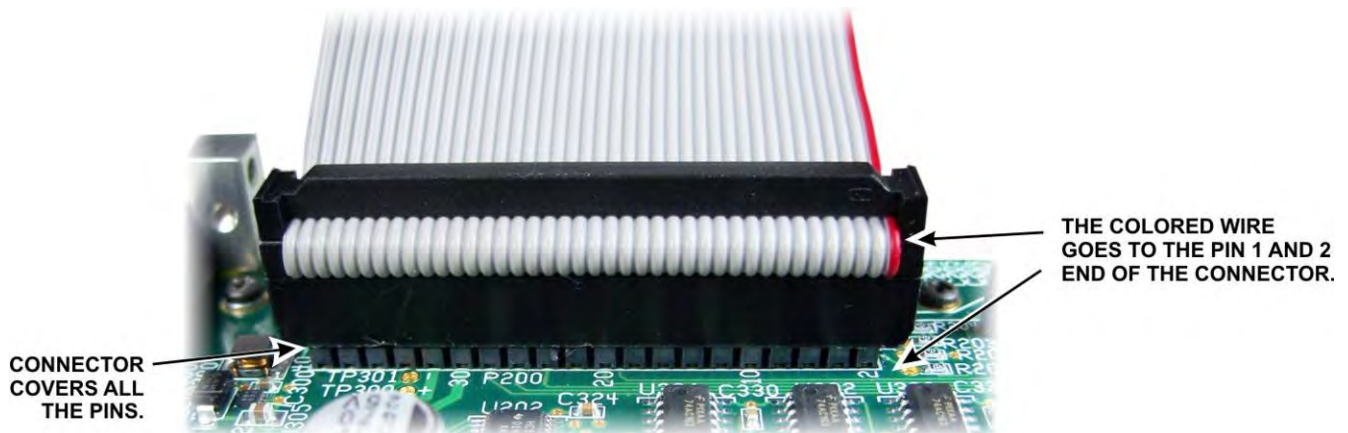

Figure 21. Mating the 40-pin Connectors.

- Mount the front panel assembly on the bottom cover end opposite the rear panel using a 3/16" (4.8 mm) pan head screw into each 2D fastener.
- Plug the free end of the ribbon cable into P504 on the I/O board or, if the P3SVGA board is installed, into P102 on the P3SVGA board. Be sure the red edge is at the Pin 1 end of the connector (the end nearest the bottom). To avoid stressing the board, support it with your fingers while mating the connector by placing your fingers on the side of the board opposite the connector and squeezing the connector in place with your thumbs. Be sure the connectors are properly aligned so that all pins engage the cable connector just as you did on the display board (see Figure 21).
- Locate the TMP coaxial cable. Plug one end into J902 on the RF board and the other end into RF IN, J100 on the front panel board. The connectors simply press into the sockets and are held in place by friction. If a connector refuses to engage, check for excess loose center conductor wires (see Figure 22).

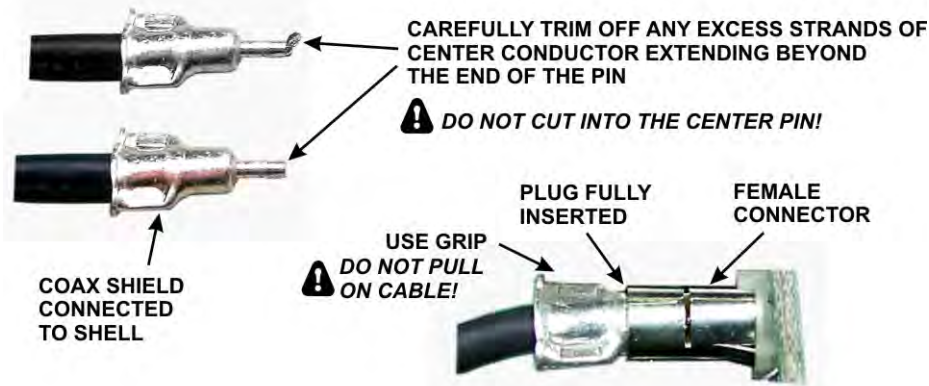

Figure 22. TMP Connectors.

- Check the position of the jumper block on P502 on the I/O board (in the top corner just above the ribbon connector) and place it according to how you want the **POWER** switch to operate (see *Configuration* on page 31).
- Inspect the inside surface of the side covers to ensure there is bare metal around each screw hold for good contact with the angle brackets or 2D fasteners. Be sure that you clean away paint on the inside surface, not the outside (see Figure 10, page 53). The screws holes are **not** countersunk on the inside surface of the panels. They are countersunk on the outside surface.

**⚠ IMPORTANT: Do not over-tighten the case screws in the following step or when mounting the top cover later. You can strip the threads or damage and scratch the screw heads.**

- Mount the side panels, using five 3/16" (4.8 mm) flat head screws in each panel. The center top hole will be filled when you install the top cover later. Although the panels are identical, they only fit one way so the holes align with the fasteners. If a screw binds or does not line up properly, loosen the other screws holding the 2D fastener or the screw into the L- bracket so it can move slightly for better alignment. If a side panel seems pushed away from the bottom cover at the center, check the L-bracket carefully. The usual cause is an L-bracket installed incorrectly (see Figure 10).

- Gather the ribbon cable into neat folds and place the clip on the cable to hold it in place as shown in Figure 23. The clip has ridges to grip the cable tightly. Use gentle folds. Avoid creasing the cable.

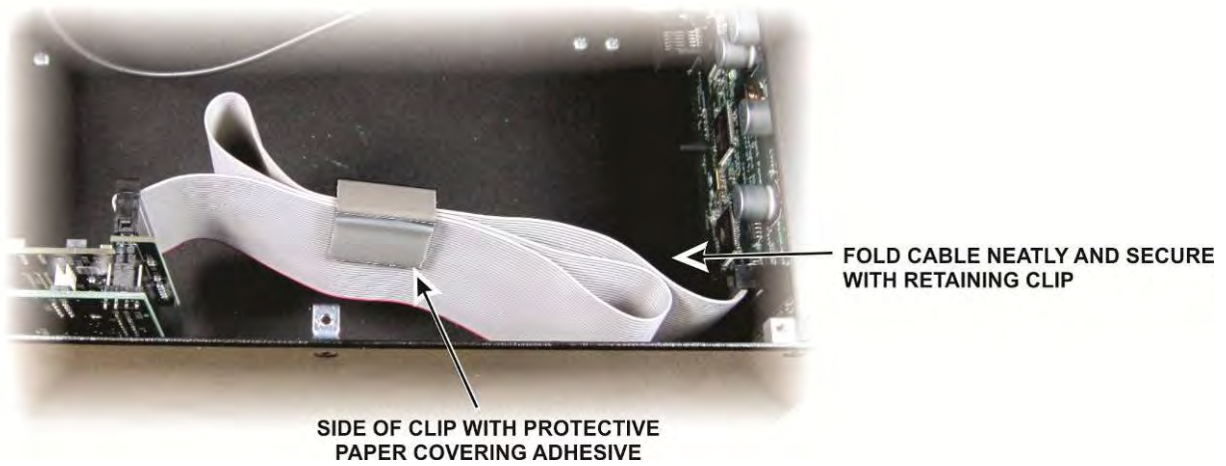

Figure 23. Placing Clip on the Ribbon Cable.

- Slide the ribbon cable through the clip to adjust the folds so the clip lies near the side panel without being pulled away by the cable (see Figure 24).
- Check the area of the side panel behind the clip to ensure it is free of dirt or oil that would interfere with the adhesive on the clip. Clean as necessary with a soft wipe moistened with a non-residue cleaner such as glass cleaner. Dry thoroughly.
- Remove the paper backing from the adhesive side of the clip and press it against the side panel as shown in Figure 24.

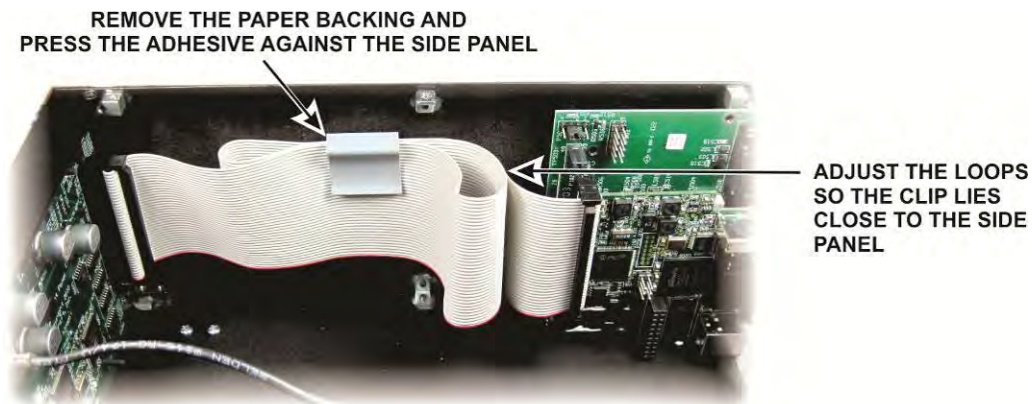

Figure 24. Clip Mounted on Side Panel.

Mount the top cover. Orient it with the notch to the rear. (The notch is to make the cover easy to remove with a fingernail or small tool if needed.) Secure the cover with six 3/16" (4.8 mm) flat head screws; four on the top and one through each side panel. If the angle brackets on the top cover do not fit properly, check the orientation of the L-bracket carefully. The usual cause is an L-bracket installed incorrectly (see Figure 10).

Inspect the enclosure from all sides, loosening and retightening screws while adjusting the panels for the best fit.

** IMPORTANT: Ensure that all case screws are tight but do not over-tighten the screws. You can strip the threads or damage and scratch the screw heads. . Good electrical contact between the enclosure panels and the circuit boards is essential for proper operation.**

That completes the assembly of your P3 Panadapter kit.

# Servicing the P3

**⚠ CAUTION:** The PC Boards inside the P3 are ESD-sensitive. Wear an ESD-safe wrist strap or touch a metallic ground regularly at any time while working inside the P3. See *Preventing Electrostatic Discharge Damage* on page 47 for more information.

## Accessing the PC Boards

There is a small slot at the back of the top cover that allows you to lift it easily with a fingernail or small tool once the screws are removed. The P3 with the top cover removed is shown in Figure 1 on page 48.

The P3 uses Elecraft's unique 2D fasteners which allow you to remove the top, bottom, front, rear, either side or any combination of panels independently. The fasteners are shown in Figure 7 on page 52.

**⚠ If a case screw is too tight to remove, it is probably because tightening the other screws in that fastener caused it to bind against the side of the screw hole. Loosen the other screws in that fastener to free it.**

The top, bottom and sides are supported at the center by L-brackets (Figure 10 on page 53).

The TMP connectors on the coaxial cable joining the front panel and RF boards are friction fit. To remove, pull on the metal ears on the connector. A slight twisting motion will help free a tight connector. ***Pull on the metal ears. Do not pull on the coaxial cable*** (see Figure 22 on page 62).

The rear-panel pc boards are held in place by their connector hardware (see page 60).

Remove the knob to remove the front panel board. The knob is held by friction (see Figure 6 on page 51).

The front panel board is secured to the front panel by the four screws at the corner of the LCD display. The LCD panel is held in place by friction against the rubber key matrix that surrounds it. Handle the assembly carefully to avoid dislodging the LCD. If you need to remove the LCD, see *Replacing the LCD Display* on page 66.

If you need to replace the front panel display board, transfer the four standoffs shown in Figure 4 on page 50 to the new board. ***Be sure to replace the lock washers between the standoff and the pc board as shown in the figure.*** Do not over-tighten the screws holding the plastic bezel and pc board on the front panel.

When reassembling, be sure the 40-conductor ribbon cable is not twisted. The colored edge should go to the pins 1 and 2 end of the connectors on the circuit boards. Pins 1 and 2 are on the end nearest the bottom of the P3 when they are installed. Be sure you have the connectors aligned so they engage all the pins. Note that one pin is missing and the corresponding hole is plugged to help you align the connectors, but it is still possible to leave one row of pins exposed.

**⚠ CAUTION:** Severe damage to your P3 may occur if the 40-conductor ribbon cable is not oriented correctly and properly mated to the connectors as described above.

## Cleaning the LCD Bezel

When the power is off and the LCD is dark, fingerprints and dust become clearly visible on the bezel covering the LCD screen. Avoid rubbing the bezel. It is easily scratched. Use a very soft cloth and gentle pressure. If the bezel requires more extensive cleaning or cleaning on the inside surface, remove the front panel assembly, lay it face up and then remove the four screws holding the bezel. Note that this will also release the front panel circuit board with the LCD. Mild liquid dish soap is a good cleaner and has the effect of dissipating dust-attracting static charges. Blot the bezel dry rather than wiping it.

If the LCD itself is dirty, use a soft cloth to wipe it clean. If necessary, dampen the cloth slightly with a mild cleaner (lens cleaner for eye glasses is good). The front surface of the LCD is a plastic polarizing filter that is essential for its operation. This filter is easily scratched.

## Replacing the LCD Display

Remove the front panel board with the LCD display from the P3 front panel. **Be careful not to damage the tiny transformers on the component side of the board (see Figure 2).** Place the board on your work table with the top of the board nearest you. Arrange a book or other object about level with the key matrix against the bottom of the front panel board to support the LCD when you free it from the key matrix (see Figure 25).



Figure 25. Removing LCD Panel from Rubber Key Matrix.

Gently pry up the top edge of the LCD panel to free it from the switch matrix and fold it over onto the support as shown. Don't strain the two delicate ribbon cables or their connectors.

Use a fingernail to open the connectors and free the cables (see Figure 26). Be especially careful with the smaller connector. Note it opens from the end farthest from the cable. The white latch opens only slightly.

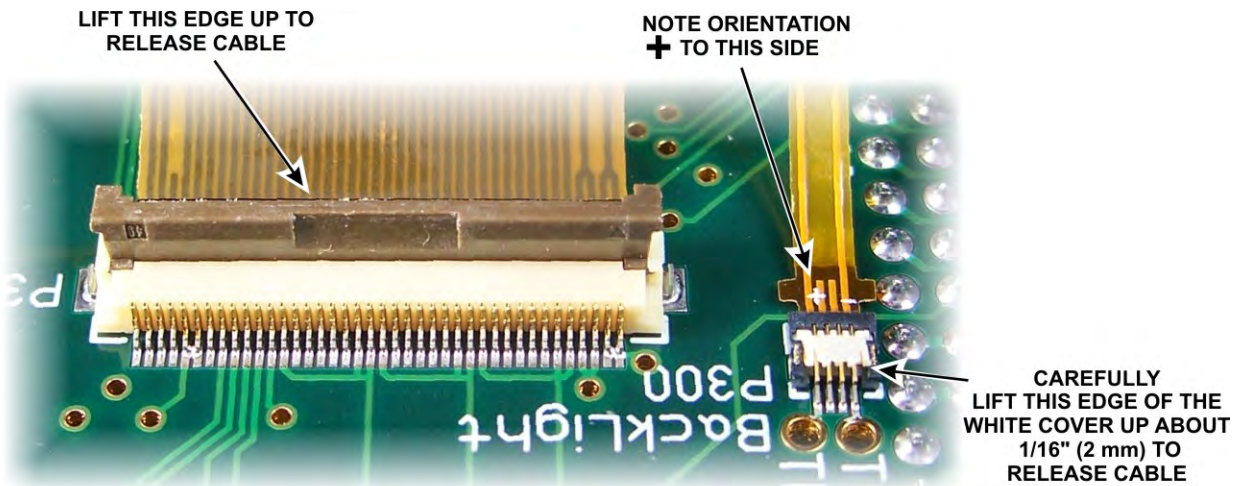

Figure 26. LCD Cable Connectors Opened.

When replacing the cables, be sure the smaller backlight cable is oriented with the + as shown.

Gently replace the LCD in the switch matrix. Be sure it is fully seated so the edge of the LCD panel is flush with the surrounding rubber matrix.