



ELECRAFT® KX3

ULTRA-PORTABLE 160-6 METER, ALL-MODE TRANSCEIVER

KIT ASSEMBLY MANUAL

Revision H, December 14, 2016

E740164

Copyright © 2016, Elecraft, Inc.

All Rights Reserved

Contents

Introduction.....	1
Customer Service and Support.....	1
Preventing Electrostatic Discharge Damage.....	3
Choosing an Anti-Static Mat.....	3
Overview of the Kit.....	4
Tools Required for Assembly.....	5
Unpacking and Inventory.....	5
Assembly Procedure.....	7
Front Panel Assembly.....	8
Bottom Cover Assembly.....	20
Final Assembly.....	37
Setup and Operation.....	42
Appendix A Illustrated Parts List.....	A1



Elecraft manuals with color images may be downloaded from
www.elecraft.com.

Introduction

This manual will guide you through assembly of your Elecraft KX3 transceiver. We're confident that you'll find the KX3 easy to build, even if you've had no prior kit-building experience.

Every modern transceiver is complex, and the KX3 is no exception. But all of the circuits are contained on a few factory-assembled and tested circuit boards. Also, virtually all of the alignment of your KX3 is handled in firmware using the KX3's built-in test capabilities.

⚠ Do not handle the circuit boards without first taking the ESD precautions listed on page 3.

If you should have difficulty, you'll have our full support via phone and e-mail. In addition, we hope you'll join our growing and enthusiastic community of owner/builders via the Elecraft reflector.

Further information about the Elecraft KX3, including specifications, installation, and operation instructions, can be found in the Owner's Manual.

Customer Service and Support

Technical Assistance

You can send e-mail to k3support@elecraft.com and we will respond quickly – typically the same day Monday through Friday. If you need replacement parts, send an e-mail to parts@elecraft.com. Telephone assistance is available from 9 A.M. to 5 P.M. Pacific time (weekdays only) at 831-763-4211. Please use e-mail rather than calling when possible since this gives us a written record of the details of your problem and allows us to handle a larger number of requests each day.

Repair / Alignment Service

If necessary, you may return your Elecraft product to us for repair or alignment. (Note: We offer unlimited email and phone support, so please try that route first as we can usually help you find the problem quickly.)

IMPORTANT: You must contact Elecraft before mailing your product to obtain authorization for the return, what address to ship it to and current information on repair fees and turnaround times. (Frequently we can determine the cause of your problem and save you the trouble of shipping it back to us.) Our repair location may be different from our factory address. We will give you the address to ship your kit to at the time of repair authorization. *Packages shipped to the factory address without authorization will incur an additional shipping charge for reshipment to our repair depot.*

Elecraft 1-Year Limited Warranty

This warranty is effective as of the date of first consumer purchase (or if shipped from the factory, the date the product is shipped to the customer). It covers both our kits and fully assembled products. For kits, before requesting warranty service, you should fully complete the assembly, carefully following all instructions in the manual.

Who is covered: This warranty covers the original owner of the Elecraft product as disclosed to Elecraft at the time of order. Elecraft products transferred by the purchaser to a third party, either by sale, gift, or other method, who is not disclosed to Elecraft at the time of original order, are not covered by this warranty. If the Elecraft product is being bought indirectly for a third party, the third party's name and address must be provided at time of order to ensure warranty coverage.

What is covered: During the first year after date of purchase, Elecraft will replace defective or missing parts free of charge (post-paid). We will also correct any malfunction to kits or assembled units caused by defective parts and materials. Purchaser pays inbound shipping to us for warranty repair; we pay shipping to return the repaired equipment to you by UPS ground service or equivalent to the continental USA and Canada. For Alaska, Hawaii, and other destinations outside the U.S. and Canada, actual return shipping cost is paid by the owner.

What is not covered: This warranty does not cover correction of kit assembly errors. It also does not cover misalignment; repair of damage caused by misuse, negligence, battery leakage or corrosion, or builder modifications; or any performance malfunctions involving non-Elecraft accessory equipment. The use of acid-core solder, water-soluble flux solder, or any corrosive or conductive flux or solvent will void this warranty in its entirety. Also not covered is reimbursement for loss of use, inconvenience, customer assembly or alignment time, or cost of unauthorized service.

Limitation of incidental or consequential damages: This warranty does not extend to non-Elecraft equipment or components used in conjunction with our products. Any such repair or replacement is the responsibility of the customer. Elecraft will not be liable for any special, indirect, incidental or consequential damages, including but not limited to any loss of business or profits.

Preventing Electrostatic Discharge Damage

Sensitive components may be damaged by Electrostatic Discharge (ESD) simply by touching them or a circuit board containing them unless you take specific steps to prevent such damage. Damage may occur with static discharges far too little for you to notice.

A damaged component may not fail completely at first. Instead, the damage may result in below-normal performance for an extended period of time before you experience a total failure.

Parts which are especially ESD-sensitive are identified in the parts list and in the assembly procedures.

We strongly recommend you take the following anti-static precautions (listed in order of importance) to ensure there is no voltage difference between the components and any object that touches them:

- Leave ESD-sensitive parts in their anti-static packaging until you install them. The packaging may be a special plastic bag that allow static charges to flow harmlessly over their surface, or a component's leads may be inserted in conductive foam that keep them at the same potential.
- Wear a conductive wrist strap with a series 1-megohm resistor that will constantly drain off any static charge that accumulates on your body. If you do not have a wrist strap, touch a ground briefly before touching any sensitive parts to discharge your body. Do this frequently while you are working. You can collect a destructive static charge on your body just sitting at the work bench.

WARNING

DO NOT attach a ground directly to yourself without a current-limiting resistor as this poses a serious shock hazard. A wrist strap must include a 1-megohm resistor to limit the current flow. If you choose to touch an unpainted, metal ground to discharge yourself, do it only when you are not touching live circuits with any part of your body.

- Use a grounded anti-static mat on your work bench (see below).
- If you pick up a pc board that was not placed on an anti-static mat or in an anti-static package, touch first a ground plane connection on the board such as a connector shell or mounting point.
- If you use a soldering iron to work on a circuit board, be sure your iron has an ESD-safe grounded tip tied to the same common ground used by your mat and wrist strap.

Choosing an Anti-Static Mat

An anti-static mat must bleed off any charge that comes in contact with it at a rate slow enough to avoid a shock or short circuit hazard but fast enough to ensure dangerous charges cannot accumulate. Typically, a mat will have a resistance of up to 1 Gigaohm (10^9 ohms). Testing a mat requires specialized equipment, so we recommend that you choose an anti-static mat that comes with published resistance specifications and clean it as recommended by the manufacturer. Testing has shown that many inexpensive mats that do not specify their resistance have resistance values much too high to provide adequate protection, even after they were cleaned and treated with special anti-static mat solutions.

Suitable anti-static table mats are available from many sources including:

- U-line (Model 12743 specified at 10^7 ohms)
- Desco (Model 66164, specified at 10^6 to 10^8 ohms)
- 3M™ Portable Service Kit (Model 8505 or 8507, specified at 10^6 to 10^9 ohms)

Overview of the Kit

The KX3 has a two part enclosure that opens for access to the batteries and for adding options. Figure 1 shows the assembled KX3 with the enclosure open.

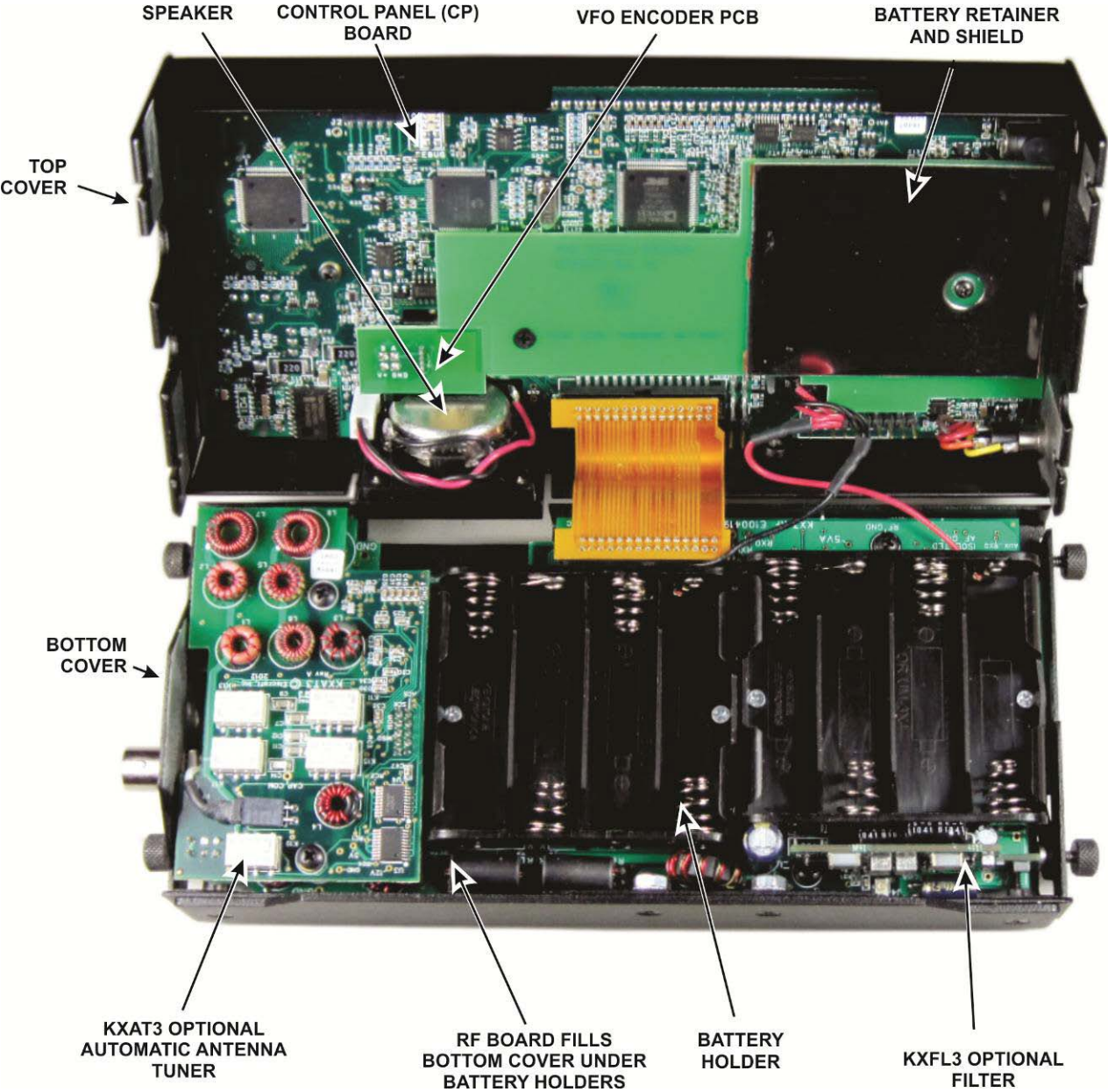

Figure 1. Complete KX3.

All of the basic KX3 circuits are contained on the two larger pc boards: the Control Panel (CP) board in the top cover and the Radio Frequency (RF) circuit board in the bottom cover. Options plug into these boards, such as the KXAT3 ATU and the KXFL3 filter shown here..

Tools Required for Assembly

1. ESD Protection (see *Preventing Electrostatic Discharge Damage*, pg 3)
2. #0 and #1 size Phillips screwdrivers. To avoid damaging screws and nuts, a power screwdriver is *not* recommended. Always use the screwdriver that best fits the screw in each step. You may need a second screwdriver for tightening certain screws (see page 36)
3. Needle-nose pliers, 4" to 6" is ideal.
4. Soft cloth or clean, soft static dissipating pad to lay cabinet panels on to avoid scratching.
5. Tweezers are handy for positioning parts in cramped spaces.
6. Straight-edge rule for checking clearances (see Figure 13, pg 13) .
7. Flush cutters (or sharp knife) for trimming nylon screws to length (see Figure 30, pg 22)
8. 3/16 nut driver (optional for mounting standoffs).

Unpacking and Inventory

CAUTION

Do not handle the circuit boards without anti-static protection! Doing so may damage sensitive components. See *Preventing Electrostatic Discharge Damage* on page 3 for important information handling the boards.

Before starting construction, do a complete inventory, comparing the parts in your kit with the parts list in Appendix A, to familiarize yourself with all of the parts and to ensure the kit is complete. When inventorying, look in the sealed envelopes to identify their contents, but not mix them up. A paper clip or piece of tape will hold the envelopes closed after you check their contents. Note that a few extras of some screws, nuts and washers may have been included on purpose.

All dimensions given in the assembly procedure are provided in both US Customary (often called English) and metric measurements. The native dimensions of the parts are in US Customary units. Approximate metric equivalents are given to assist those more familiar with the metric system to identify the correct parts.

Screws

A number of different types and sizes of screws and washers are used in the assembly. It is very important that you use the screw specified in each location or your finished KX3 may not fit together properly. In some places, using the wrong size screw may damage components. The following various screw types and sizes specified in the text are shown in Figure 2. Images are shown for comparing relative sizes. Due to the printing process used, they may not be exactly to scale. The lengths of the screws called for in the text are measured as shown.







SCREW AS IDENTIFIED IN TEXT	RELATIVE SIZE	MEASURING SCREW LENGTHS
2-56 5/32" (4.0 mm) BLACK PAN HEAD		FROM BOTTOM OF PAN HEAD TO END OF THREADED SHAFT
4-40 3/16" (4.8 mm) BLACK FLAT HEAD		
2-56 1/4" (6.4 mm) BLACK PAN HEAD		FROM TOP OF FLAT HEAD TO END OF THREADED SHAFT
4-40 1/4" (6.4 mm) BLACK NYLON PAN HEAD		
2-56 9/32" (7.2 mm) ZINC FLAT HEAD		FROM TOP OF FLAT HEAD TO END OF THREADED SHAFT
4-40 5/16" (7.9 mm) BLACK FLAT HEAD		
4-40 3/8" (9.5 mm) BLACK PAN HEAD		

Figure 2. Screws Used to Assemble Your KX3.

Standoffs

A number of threaded standoffs are used. Standoffs with 2-56 and 4-40 threads are used in the kit with lengths of 3/16" (4.8 mm) and 5/16" (7.9 mm). Standoff lengths are measured as shown in Figure 3. If you place the standoffs side-by-side on your table, you can see which are shorter and longer by eye.

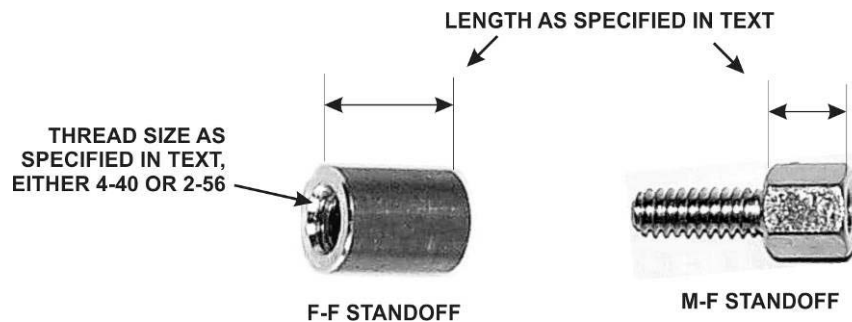

Figure 3. Typical Standoffs.

Assembly Procedure

IMPORTANT ASSEMBLY INFORMATION

- **Check off the steps as you finish each one.** Skipping a step is easy to do without taking a moment to be certain that you completed the previous step. This can result in serious damage to your KX3 or, as a minimum, having to disassemble it to correct the mistake.
- **Use your rule to check the length of screws and standoffs before installing them.** Some components are only 1/16" different from others but using the wrong size may result in parts not fitting correctly, possibly damaging electrical and mechanical components. See *Screws* and *Standoffs* on pg 6 for measurement instructions.
- **Start all the screws in an assembly before tightening.** When mounting parts with multiple screws or adjacent parts that fit together, start all the screws in the threads before tightening any of them. If you find that a screw is binding, loosen the other screws to free it, and then re-tighten.
- **Ensure all screws are tight but do not over-tighten.** Do not attempt to turn screws and nuts beyond the point at which the lock washer is compressed. Screws without lock washers should be tightened only until you feel significant resistance to further turning. Do not attempt to turn screws or nuts 1/4 turn beyond "tight".
- **Threads can be easily stripped** if too much force is applied when tightening screws. Use the correct size hand tool and apply only moderate torque. Do not use a power screwdriver!
- **Do not adjust the turns on any toroids.** The position of the turns on the cores of many toroids has been adjusted at the factory to produce exactly the inductance needed for the circuit to work properly. Any attempt to adjust their position or to make a coil look "nicer" may seriously degrade circuit performance.
- **Remember your ESD protection.** Failure to observe ESD precautions may result in your KX3 not operating at all, or operating but not meeting normal factory performance specifications due to damaged components. See Preventing Electrostatic Discharge Damage on pg 3.
- **Handle PC Boards by their Edges.** Avoid unnecessary mechanical stress on any pc board components by careless handling.

Front Panel Assembly

□ Inspect the inside surface and tabs at the ends of the KX3 front panel sheet metal and remove the masking tape from the areas shown in Figure 4. Failure to provide good electrical contact at all the points shown may seriously degrade the performance of your KX3. The tape is not ordinary masking tape. It is a strong plastic tape. You can loosen most pieces by pushing a blunt tool through the hole from the other side. The Allen wrench supplied for mounting the VFO knob will fit the smaller holes. If the tape breaks, you can grab the broken edges with your needle nose pliers and peel it off. Optionally, you can press on the edge of the tape with your fingernail or blunt tool (Figure 5) to peel up the edge of the tape enough to grab an edge with your needle nose pliers. If you find any adhesive residue left behind, place a piece of ordinary cellophane tape on the area and then peel it off. The residue will generally come off with the tape.



Figure 4. Front Panel Clean Contact Areas.

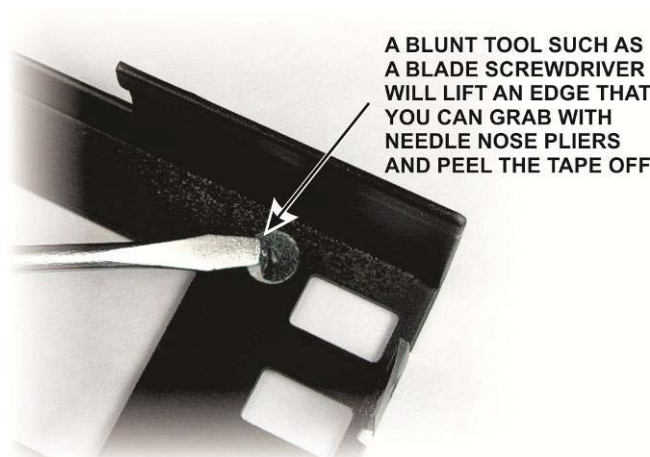

Figure 5. Removing Masking Tape.

- Inspect the inside surface of the side panels. Remove any masking tape and ensure the metal is clean in the areas shown in Figure 6.

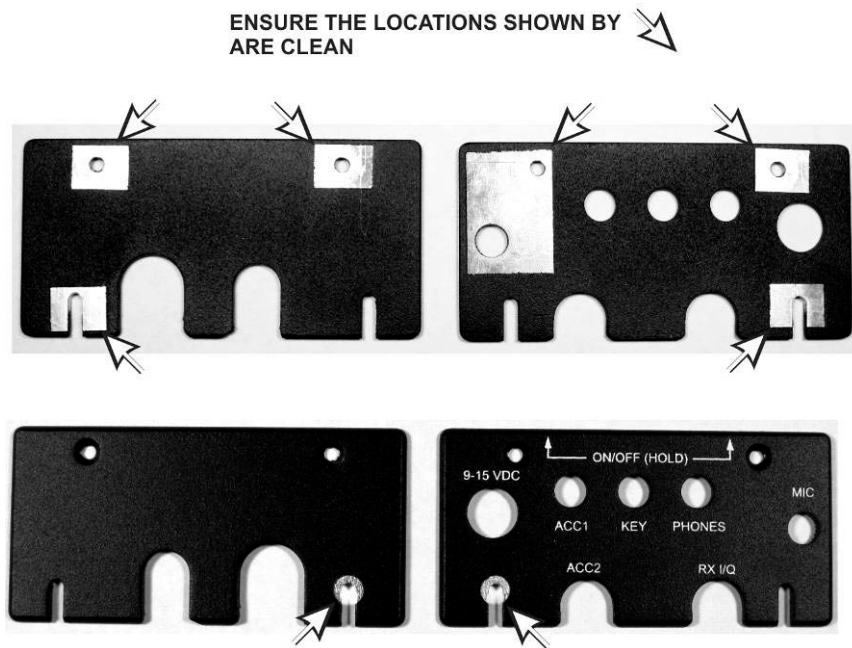

Figure 6. Side Panels Clean Contact Areas.

⚠ NOTE: Areas of the bottom cover also need to be clean. If you wish to do all the metal cleaning at once, turn to pg 20 before returning here to continue the assembly.

- Locate the speaker and dress the cable attached to it as shown in Figure 7. This is important to ensure the speaker is oriented correctly when you install it.

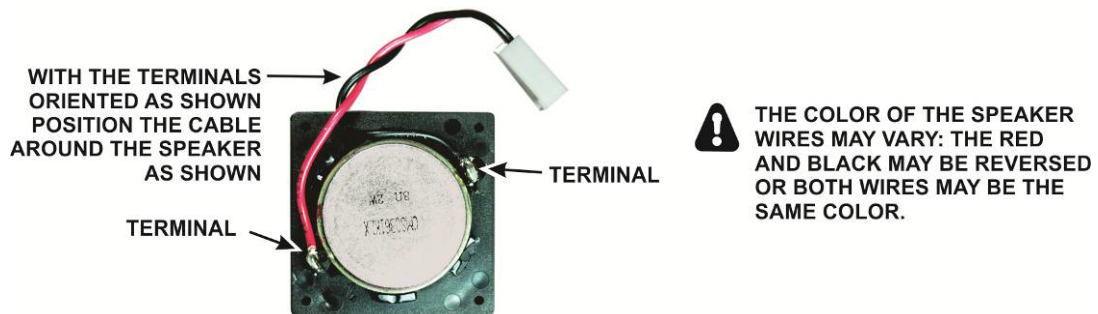

Figure 7. Dressing the Speaker Cable.

⚠ The speaker contains a very strong magnet that easily picks up hardware, bits of wire, etc. Be sure nothing is picked up by the speaker. Check both the cone in the front and the magnet at the back.

Place the speaker with the cone upwards and place the gasket on the frame as shown in Figure 8.



① PLACE THE GRILLE CLOTH BETWEEN THE SPEAKER AND THE SHEET METAL AND POSITION THE SPEAKER SO THE TERMINALS ARE AS SHOWN

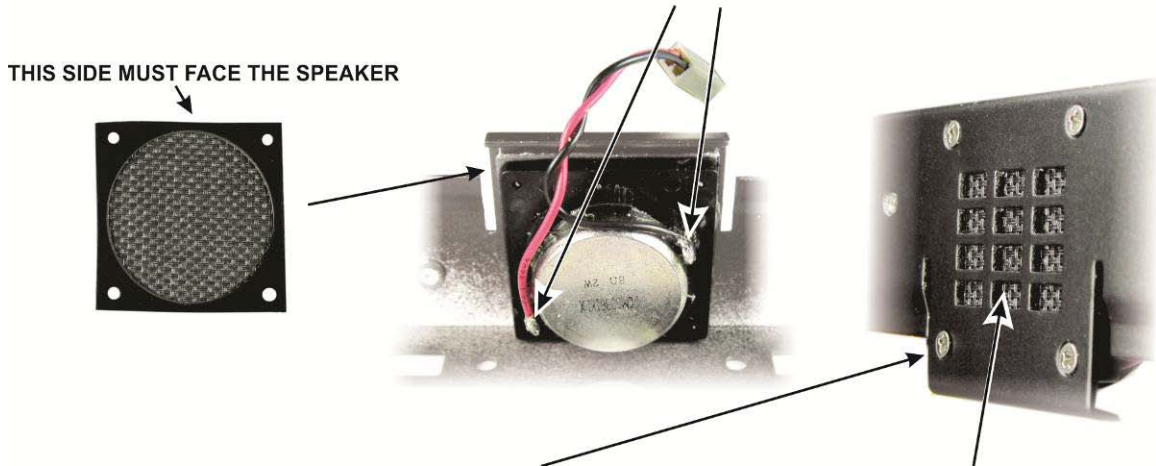

② SECURE THE SPEAKER WITH FOUR 2-56 9/32" (7.2 mm) ZINC FLAT HEAD SCREWS

③ ENSURE THE GRILLE CLOTH LIES FLAT AGAINST THE SHEET METAL

⚠ THREAD SCREWS IN ONLY UNTIL THE HEADS REACH THE PANEL. DO NOT TIGHTEN FURTHER OR YOU WILL STRIP THE THREADS IN THE PLASTIC SPEAKER FRAME.

Figure 8. Installing the Speaker.

□ Taking ESD precautions, remove the control panel (CP) board assembly from its protective envelope. Handle the assembly carefully to avoid damaging it or smudging the face of the LCD. Install the three standoffs as shown in Figure 9. Be sure you put the correct size hardware in each location and that you include all of the lock washers shown.

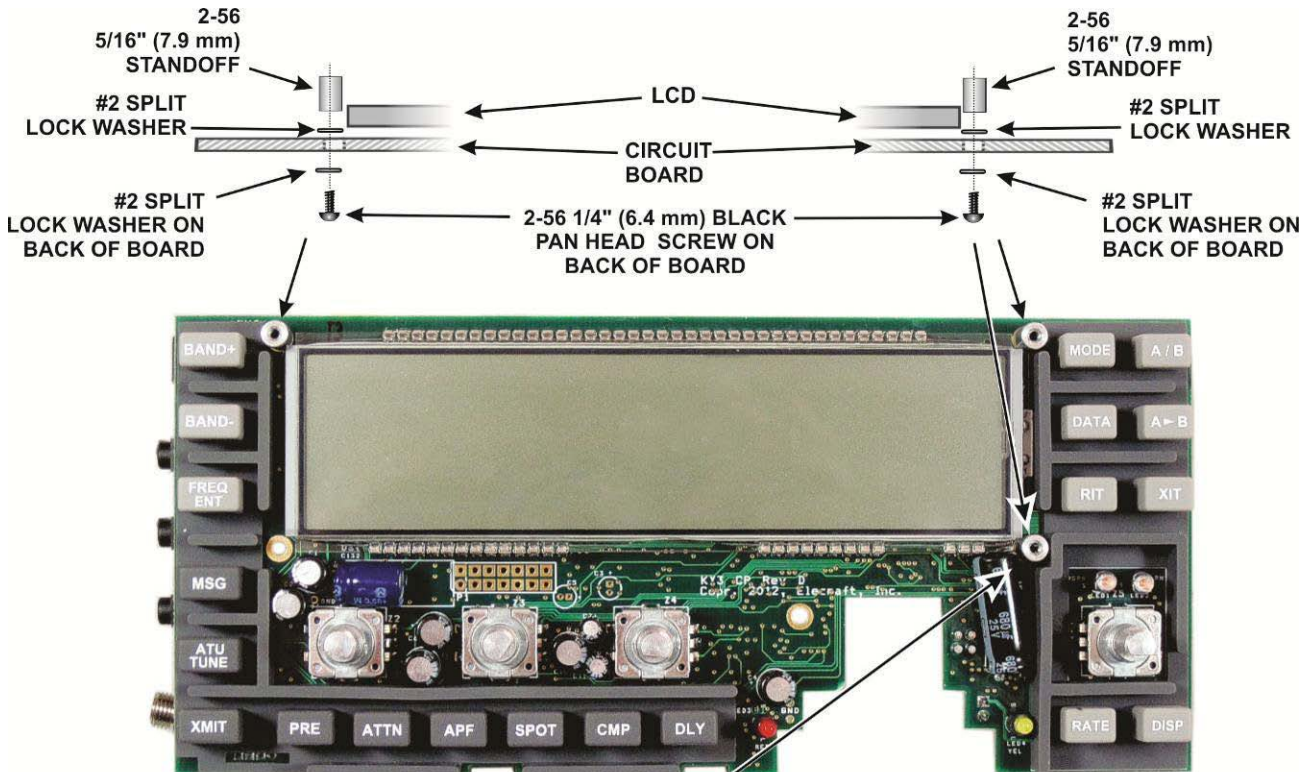

- ⚠ WHEN MOUNTING THIS STANDOFF:**
- IF NEEDED, GENTLY PUSH THE TOP OF THE LARGE CAPACITOR ASIDE TO MAKE ROOM FOR THE STANDOFF.
 - SOME BUILDERS FIND THAT IT IS EASIER TO INSTALL THE LOCK WASHER HERE BY CAREFULLY CENTERING IT OVER THE HOLE ON THE PC BOARD AND THEN BRINGING THE SCREW UP FROM BEHIND THROUGH THE BOARD AND THE LOCK WASHER.

Figure 9. Installing CP Board Standoff Hardware – Part 1.

Install the standoff on the CP board as shown in Figure 10. Note that a M-F standoff is used instead of a screw on the back of the board.

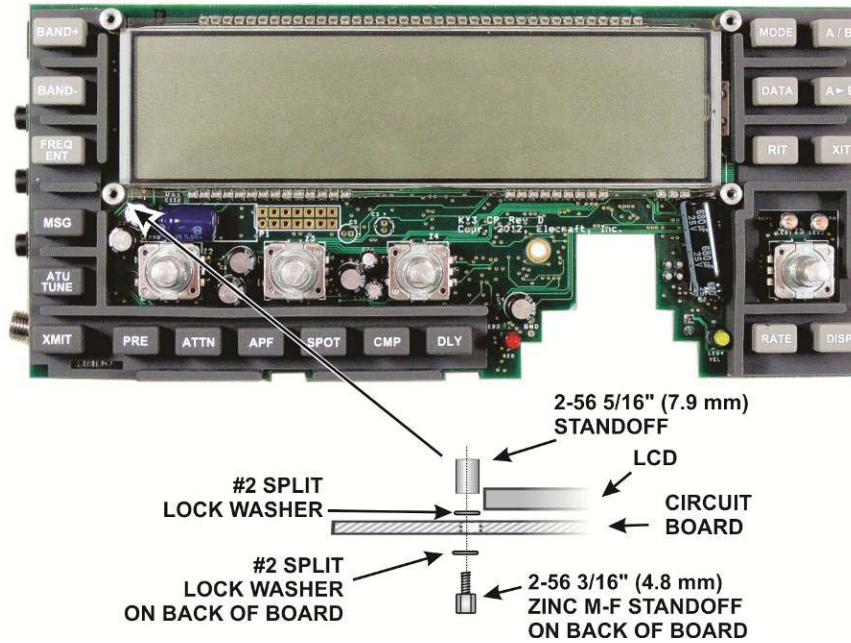

Figure 10. Installing CP Board Standoff Hardware - Part 2.

Install the remaining standoff on the CP board as shown in Figure 11. Note that this standoff uses larger 4-40 hardware and a M-F standoff on the back side of the board.

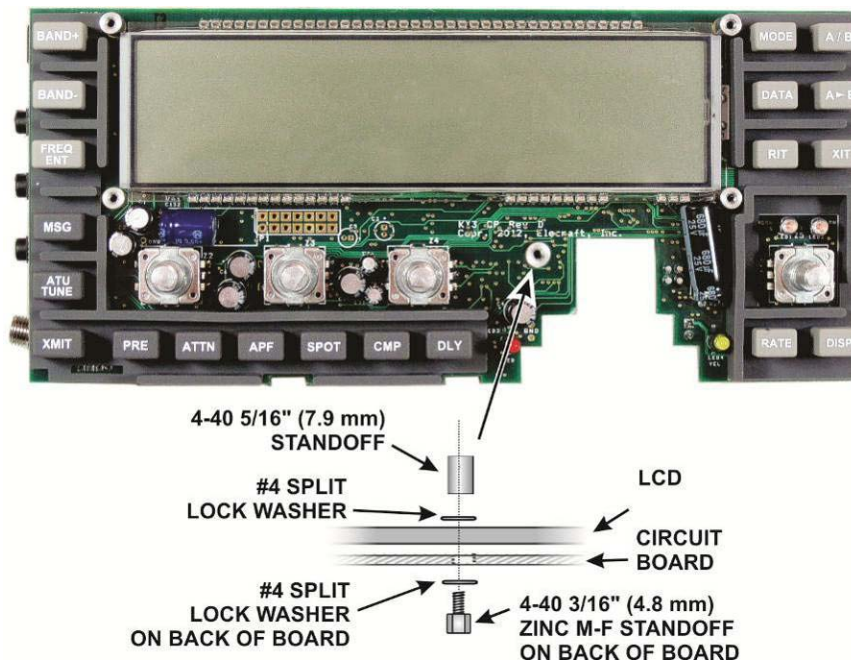

Figure 11. Installing CP Board Standoff Hardware - Part 3.

☐ Turn the control panel board assembly over and inspect it to be sure that the standoffs are in the correct locations as shown in Figure 12. Also, confirm that you have placed a lock washer between each standoff and screw and the pc board.

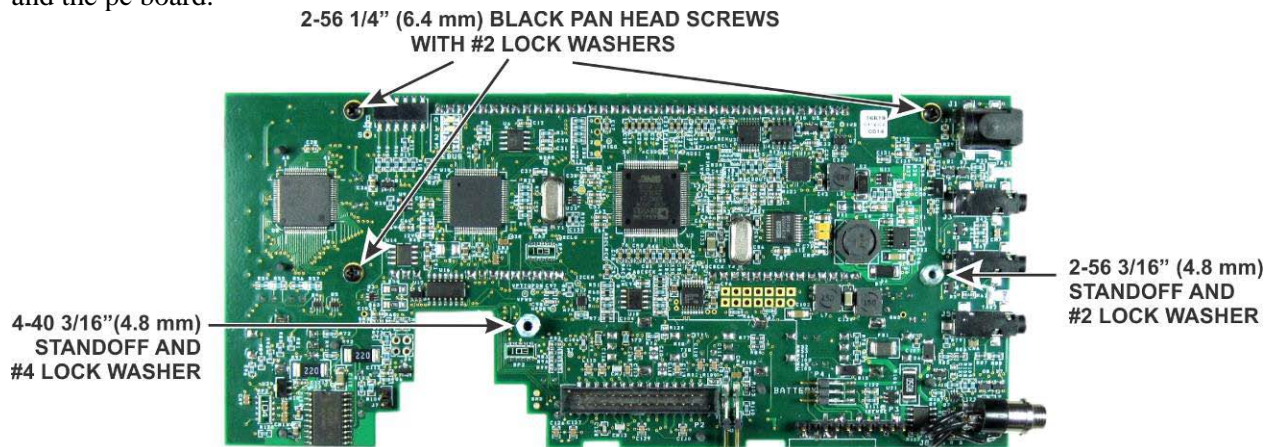

Figure 12. CP Board Standoff Hardware - Back.

☐ On the front side of the board, place a straight edge across the top of two standoffs as shown in Figure 13 and confirm that the straight edge does not touch the LCD at any point. If it does, most likely you left out one of the lock washer spacers shown in Figure 9. Move the straight edge to the remaining two standoffs and repeat the test.

⚠ CAUTION!

If the LCD touches the straight edge in this test, you will break the display when you install it in the front panel sheet metal. Correct the problem before proceeding.

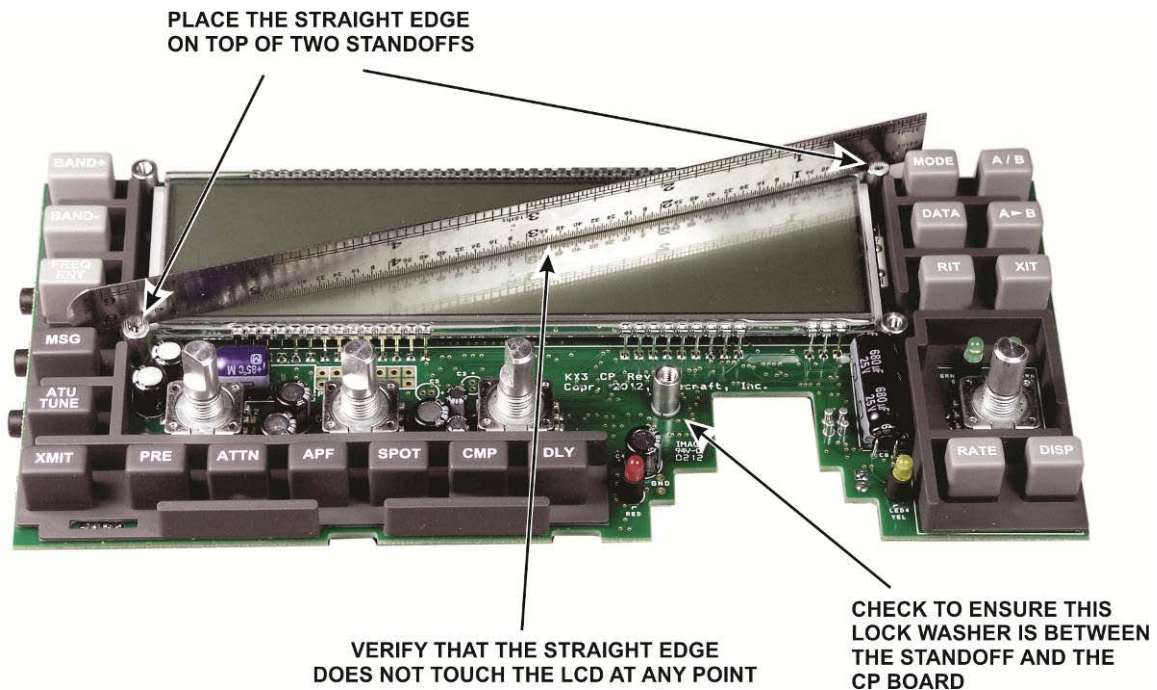

Figure 13. Checking Standoffs.

- Verify that you placed a lock washer between the 4-40 standoff and the pc board as shown in Figure 13.
- Inspect the front of the display for smudges or dust. Remove smudges by wiping it gently with a soft cloth. Blow off any dust.
- Locate the plastic bezel and inspect it for dust or smudges. If necessary, you can wash it with mild dish soap. Dry it with a soft cloth to avoid scratches.
- Place the front panel over the CP board as shown in Figure 14. You will need to reach under the CP board and lift it up into position with the four encoders through the corresponding holes in the front panel. While positioning the CP board:
 - Be sure all of the switch covers are aligned in the holes so you can feel each switch operate when pressed. All of the switches should stand slightly above the panel.
 - Verify that all four LEDs are aligned with the holes in the front panel.
 - No hardware is used on the four encoder shafts.
- Place the bezel on the front panel and secure it, and the CP board inside, as shown in Figure 14.

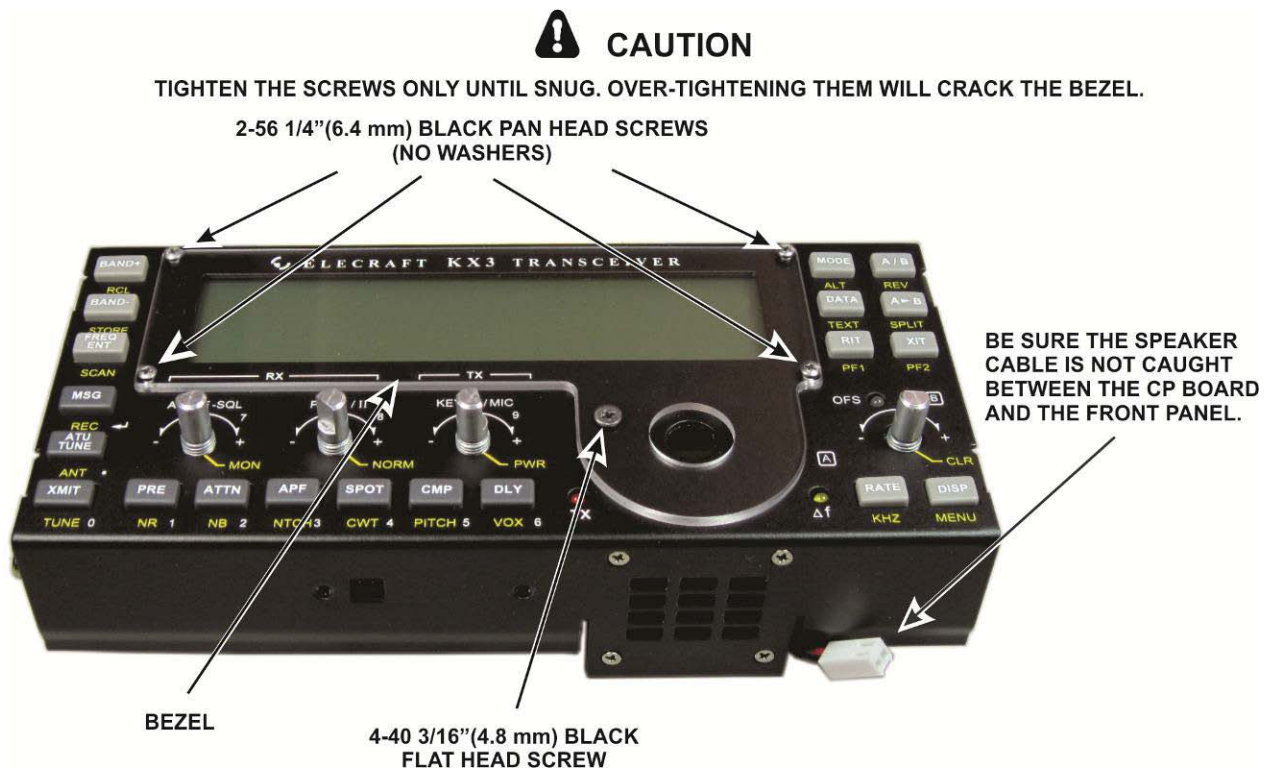

Figure 14. Placing the CP Board in the Front Panel.

- Test all of the front panel pushbutton switches to ensure they move easily in the panel openings without binding. If any do bind, loosen the bezel screws as needed to adjust the rubber so it will move freely, and then retighten everything.

- Locate the VFO encoder, lock washer and two hex nuts. Thread one nut onto the shaft until it reaches the end of the threads as shown in Figure 15. Note that a small gap between the nut and the encoder body is normal.

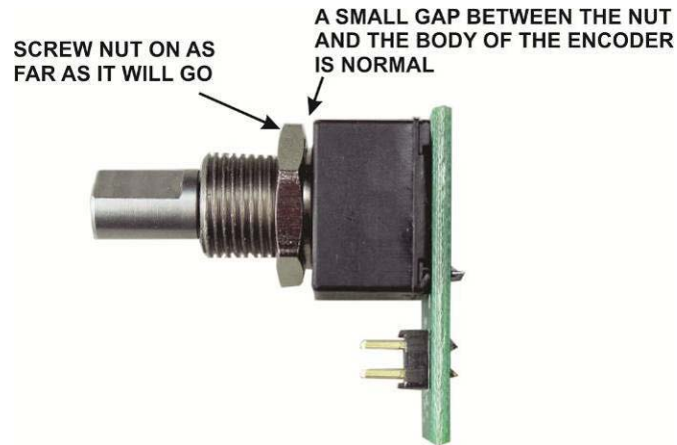

Figure 15. Preparing the VFO Encoder for Installation.

- Carefully position the encoder with its shaft through the opening in the front panel while mating the four pins with J6 (see Figure 16).

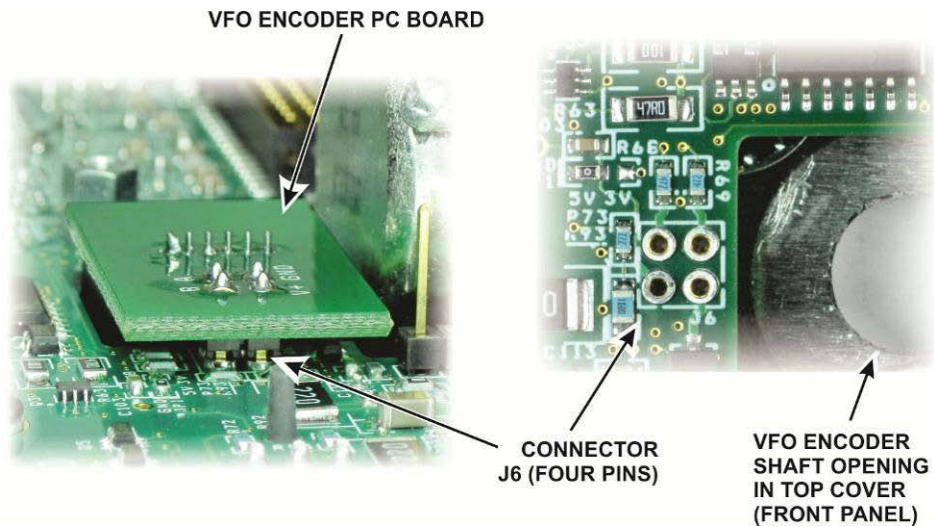

Figure 16. Installing the VFO Encoder.

- Plug the speaker connector into J7 next to the VFO encoder board (see Figure 17).

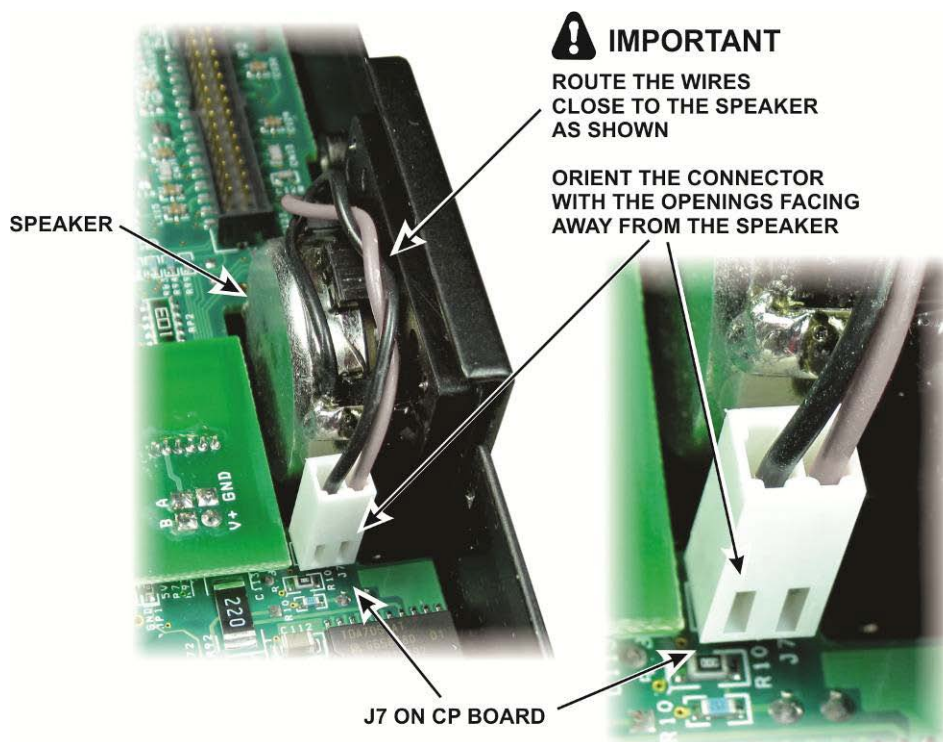

Figure 17. Connecting the Speaker to the CP Board.

! Be certain you oriented the speaker plug as shown in Figure 17. Reversing it may result in intermittent or distorted audio from the speaker.

- Turn the front panel assembly over and lace the lock washer and remaining hex nut on the VFO encoder. Tighten the nut using your needle nose pliers since there is very little space for a wrench or nut driver. Tighten only until the nut is snug and pressing into the teeth on the lock washer. Do not over tighten or you may force the encoder to turn, damaging the encoder pc board and possibly the CP board too.

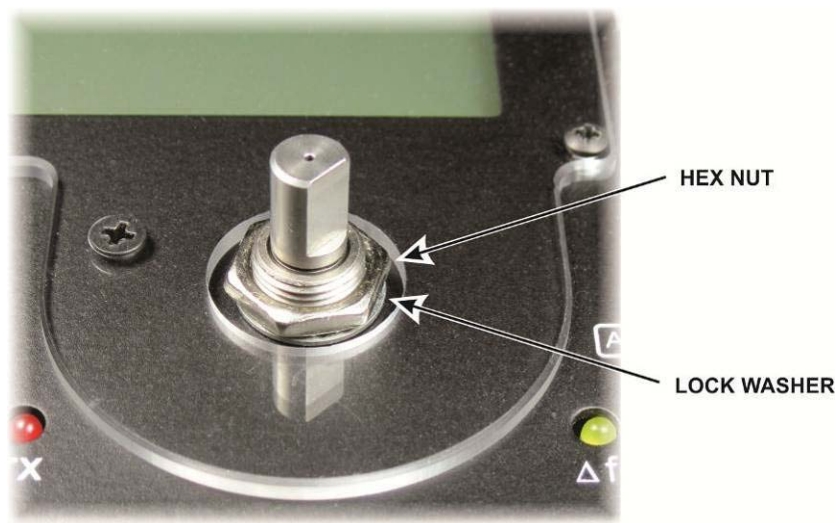

Figure 18. Encoder Mounting Hardware.

□ Install the side panels as shown in Figure 19. The MIC connector is supplied with the finish nut threaded onto it. Remove the nut and replace it as shown after mounting the side panel.

4-40, 3/16" (4.8 mm) BLACK FLAT HEAD SCREWS - TWO IN EACH END PANEL

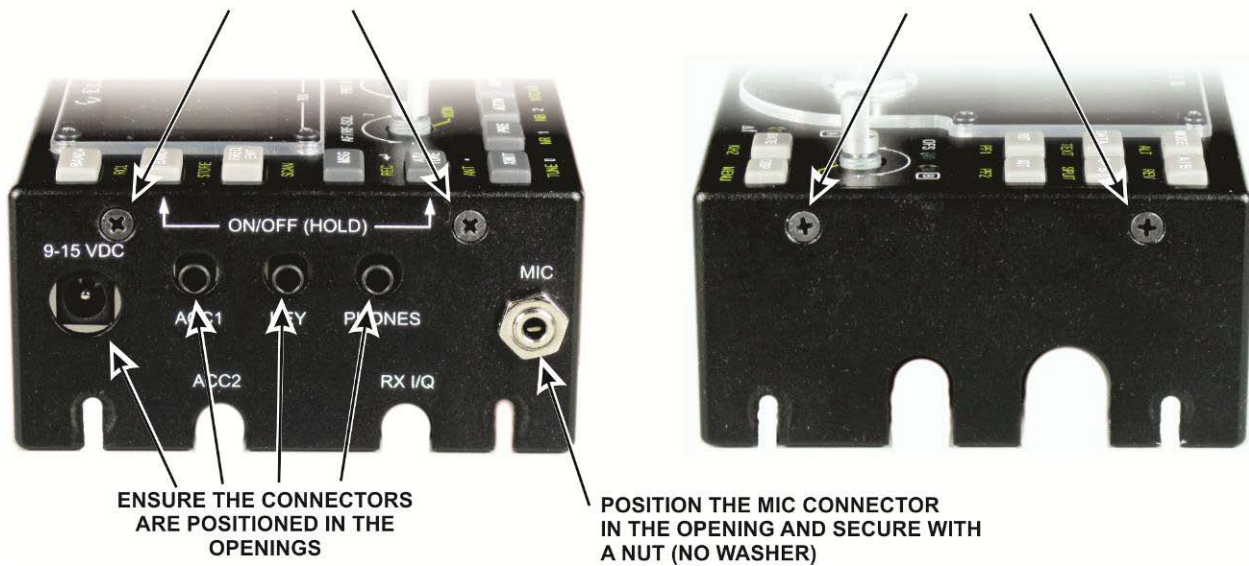

Figure 19. Mounting the Side Panels.

□ Mount the large knob on the VFO encoder shaft as shown in Figure 20. Best practice is to align the set screw with the flat on the shaft. Adjust the height of the knob for the desired amount of friction against the felt washer. A good starting point is to let the weight of the knob determine the pressure. The rubber finger grip slides off to allow adjustment later.

⚠ Some set-screws turn stiffly in the knob, making it difficult to tell when it has reached the encoder shaft. Try yours before placing the knob on the shaft to see how much torque is required. Also, exercising it this way may loosen the fit slightly.



Figure 20. Mounting the VFO Knob.

Press small knobs on the four remaining encoder shafts. These knobs are all the same size and are held in place by a friction spring as shown in Figure 21. Align the flat in the knob with the flat on each shaft before pressing each knob in place. If they are a tight fit, support the CP board with your fingers while pressing each knob in place. In addition to the rotating encoder, each knob has a switch that is actuated by pressing the knob toward the panel. You will feel the switch action when you press each knob onto the shaft.

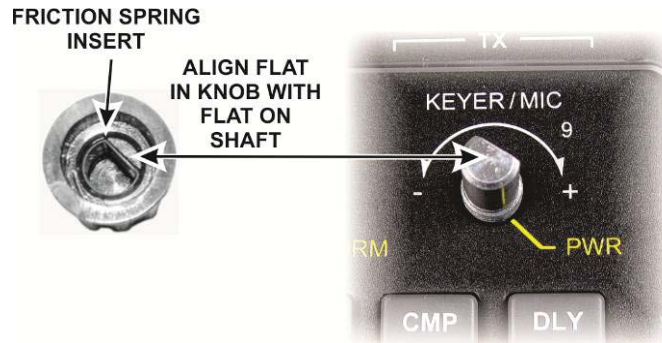

Figure 21. Mounting Friction Knobs.

⚠ If you purchased the KXBC3 Battery Charger and Real Time Clock option with your kit, skip the following step and both steps on the following page. Instead turn to Installing the KXBC3 Module in your KXBC3 manual and follow the steps there to mount the module, and then resume assembly of your KX3 with *Bottom Cover Assembly* on page 20.

Mount the nylon standoff on the battery retainer as shown in Figure 22. Be sure you place it in the correct location with the head on the lettered side of the retainer. The hole for the screw is countersunk on that side as well.

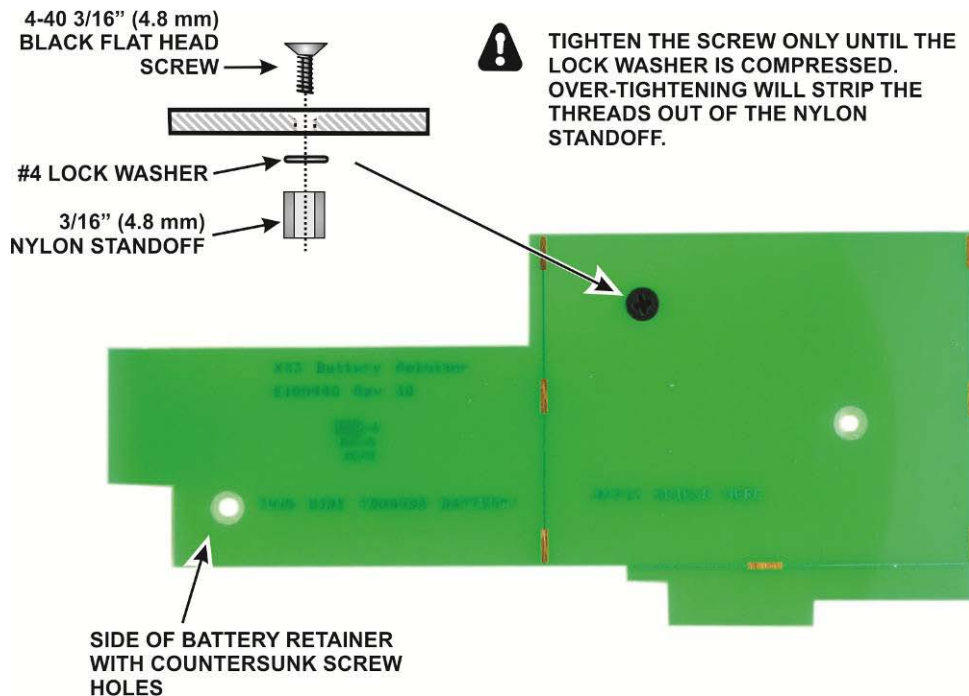

Figure 22. Mounting Nylon Standoff on the Battery Retainer.

Locate the area on the battery retainer marked “Affix Shield Here”. Peel the protective back covering off of the large metal shield and align the shield carefully with the lines and edges of the retainer as shown in Figure 23 with the hole over the screw opening. Work over the entire surface, squeezing the shield against the retainer. You may notice a slight dimple appear where it covers the screw installed in the previous step. That is normal.

⚠ CAUTION!

If the shield is not firmly attached to the battery retainer it may cause a short circuit to the internal batteries.

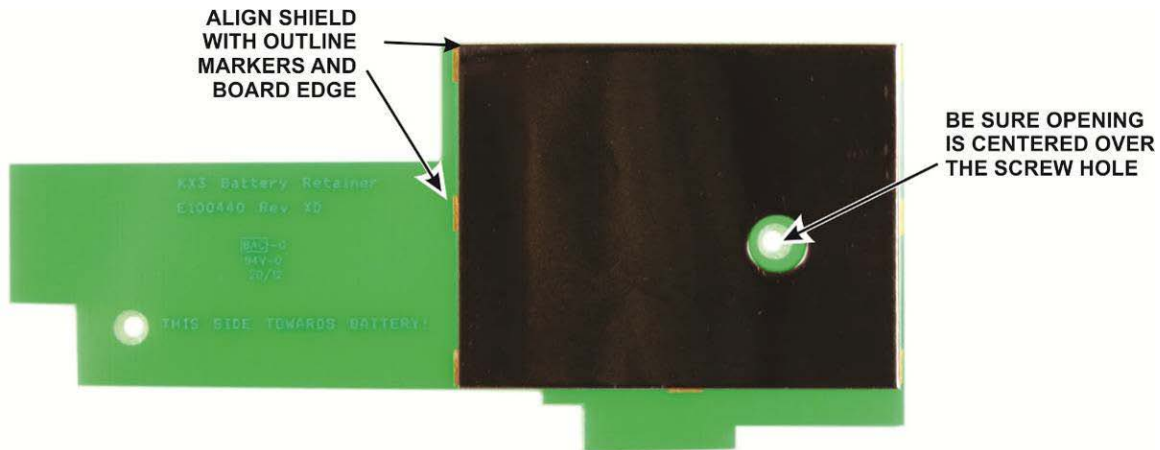

Figure 23. Positioning the Shield on the Battery Retainer.

Mount the battery retainer on the two standoffs on the CP board as shown in Figure 24. Note that the nylon standoff you installed on the retainer earlier (Figure 22) simply rests against the CP board.

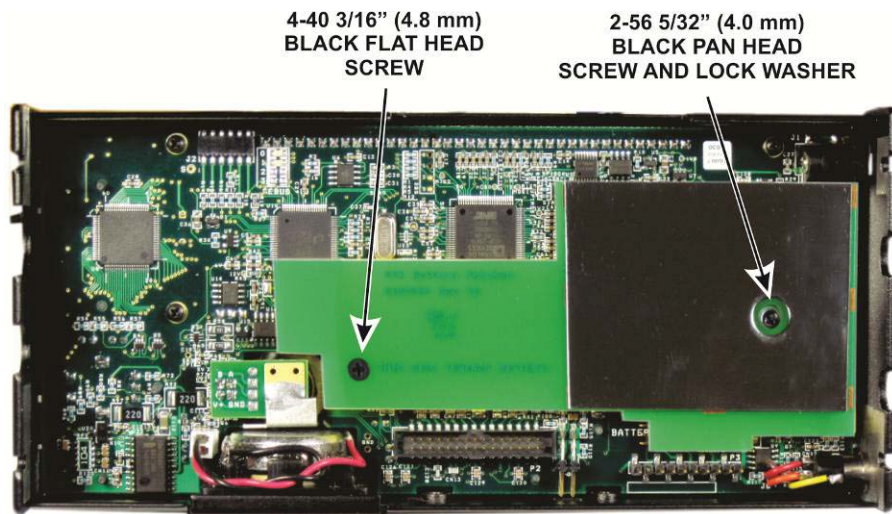

Figure 24. Installing the Battery Retainer.

Bottom Cover Assembly

Remove any masking tape from the bottom cover sheet metal and ensure the metal is clean in the areas around the four screw holes in the bottom and the areas on the sides shown in Figure 25. Good electrical contact with the hardware at all of these points is very important for proper operation of your KX3.

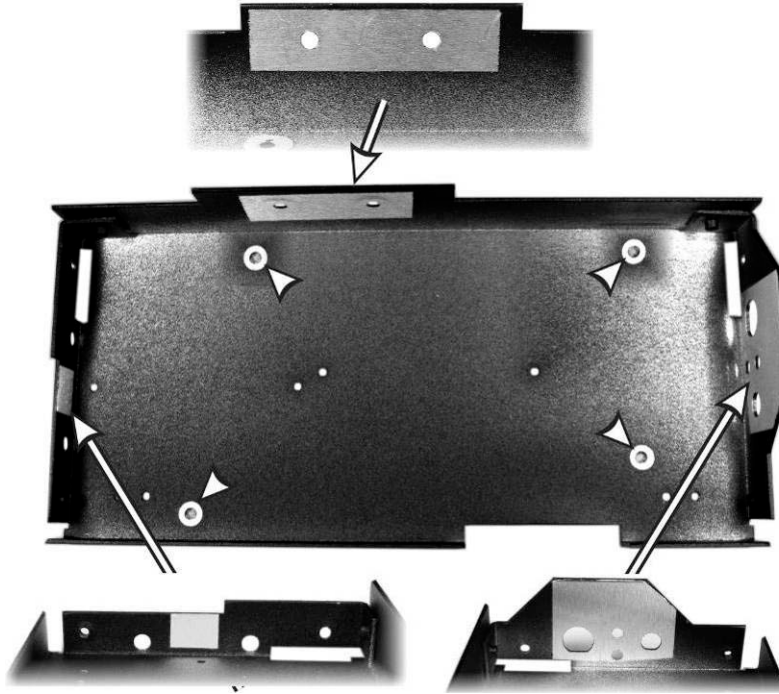

Figure 25. Bottom Cover Clean Contact Areas Inside.

Inspect the outer surface at each end of the bottom cover. Remove any masking tape and ensure the metal is clean in the areas shown in Figure 26.

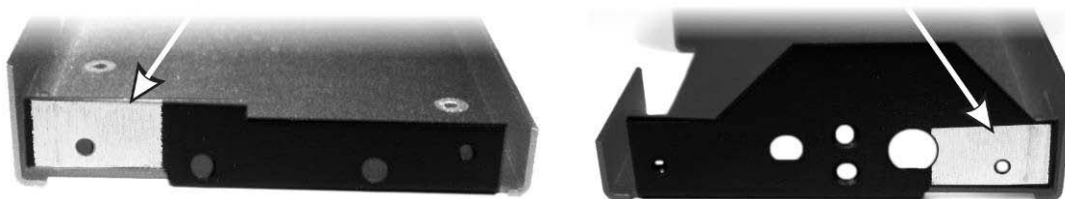

Figure 26. Bottom Cover Clean Contact Areas Outside.

- Peel the protective cover off of the back of the self-adhesive serial number label and affix it to the bottom cover as shown in Figure 27.

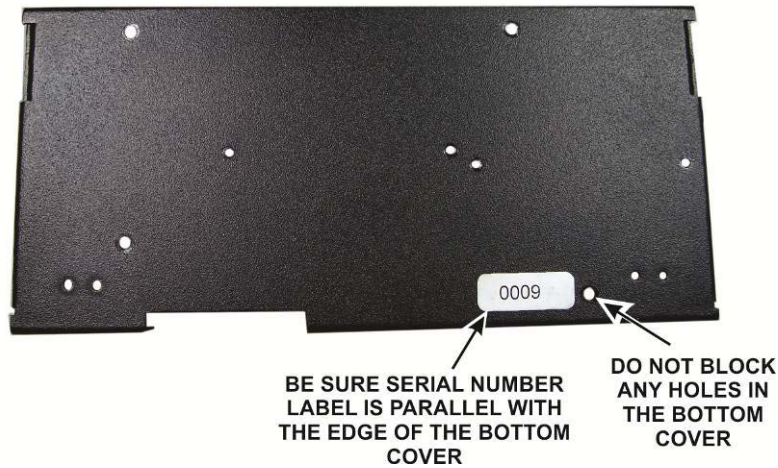

Figure 27. Placing the Serial Number on the Bottom Cover.

- Mount two of the four rubber feet on the bottom cover using **nylon** screws as shown in Figure 28. First clear any paint out of the threads with one of the black 4-40 thumbscrews. Orient the feet so that the heads of the screws are recessed in the large openings in the feet.

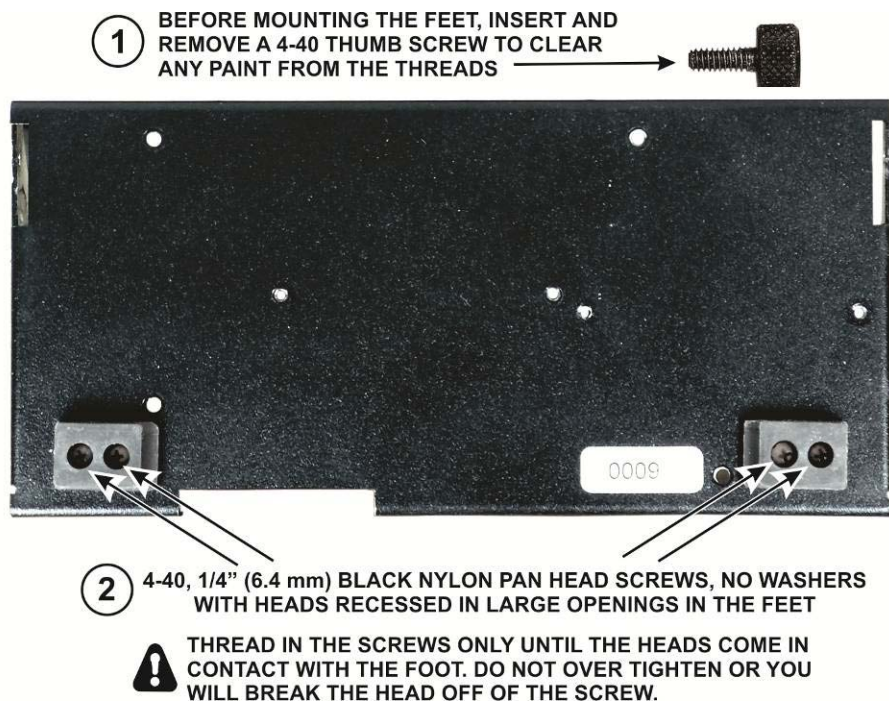

Figure 28. Mounting Rubber Feet on Bottom Cover.

- On the inside of the bottom cover, trim all four nylon screws flush with the cover.

- Use the black thumb screw to clear any paint from the threaded holes in the tilt legs (see Figure 29).
- Slide the remaining two rubber feet onto the tilt legs as shown in Figure 29. The feet are held in place by friction. Be sure you work the feet all the way onto the legs as shown.

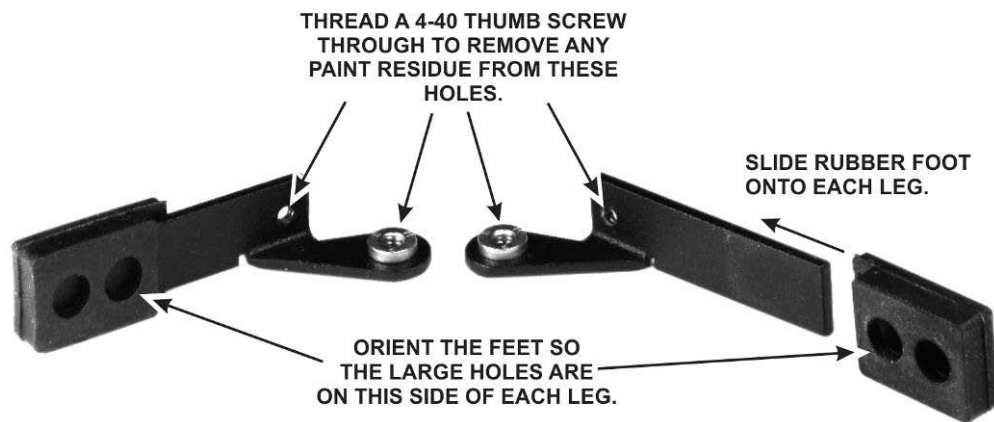

Figure 29. Preparing Tilt Legs for Installation – Part 1.

- Install a flat fiber washer and black nylon screw on each tilt leg as shown in Figure 30. Note the orientation of the screw as well as the rubber foot that you installed earlier. They must be as shown for the foot to work properly.

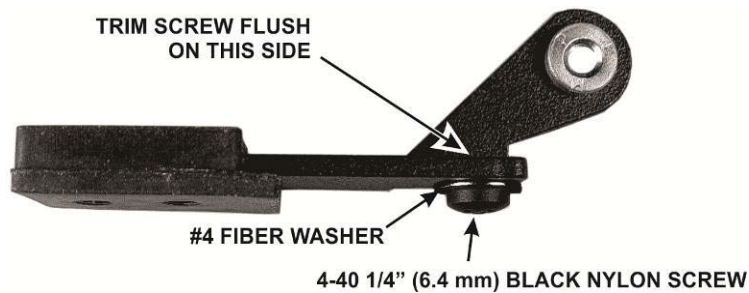

Figure 30. Placing Nylon Bumpers on the Tilt Legs.

- Verify that you trimmed the screws flush with the legs as shown in Figure 30. Set the legs aside. They will be installed later.

- Install the four #4 (larger) standoffs in the bottom cover as shown in Figure 31.

⚠ CAUTION! Place the lock washers between the standoff and the bottom cover as shown. If they are left out the cover will strike the RF pc board when it is installed.

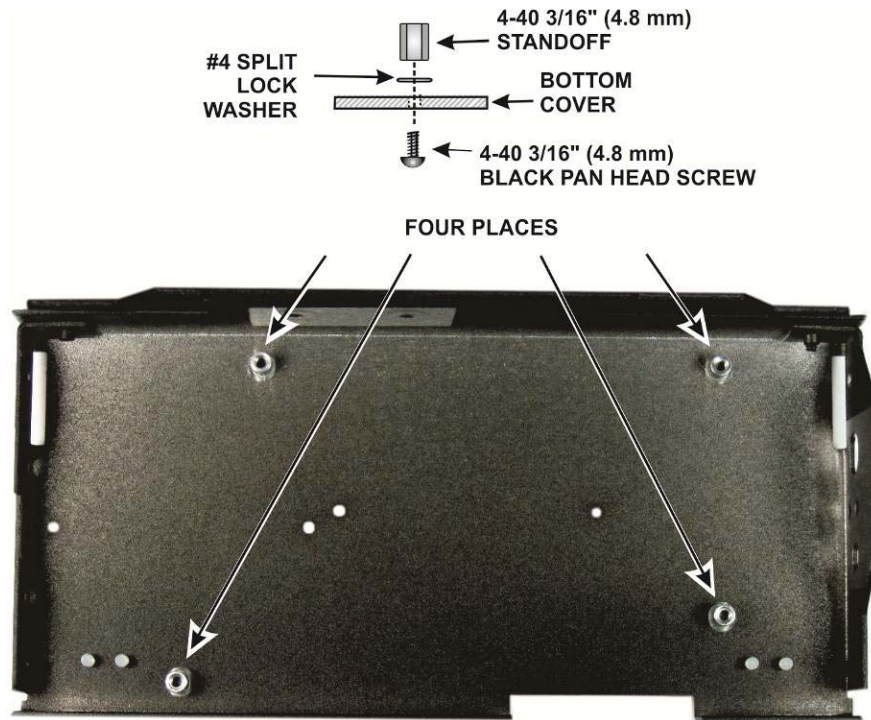

Figure 31. Installing 4-40 Standoffs in the Bottom Cover.

Install the four #2 (smaller) standoffs in the bottom cover as shown in Figure 32. **Place the lock washers between the standoffs and the cover as shown to provide proper clearance for the RF board when it is installed. Leaving the washers out may result in damaged components on the RF board.**

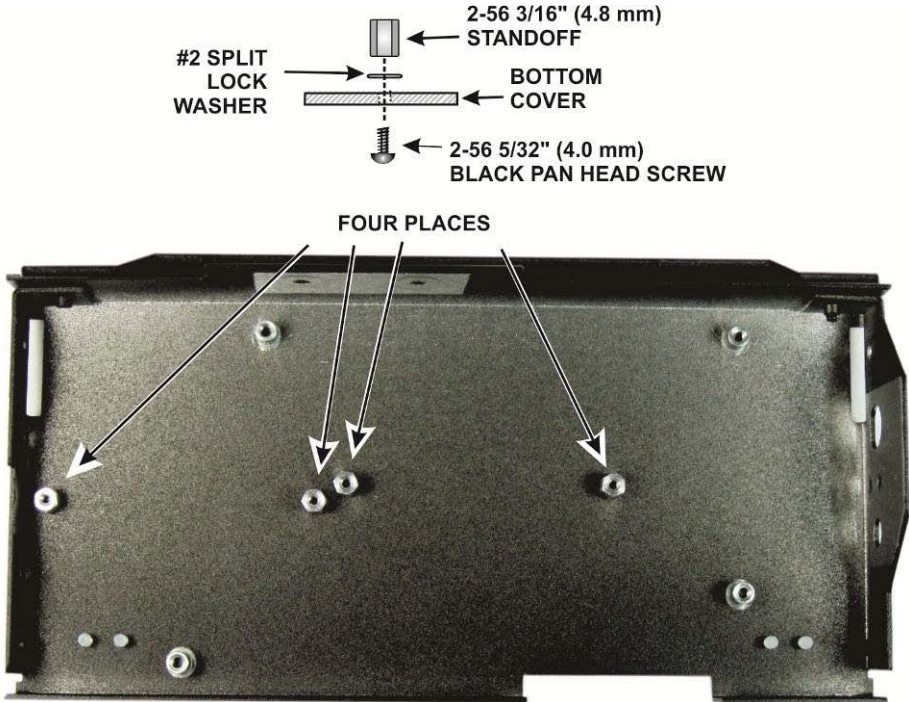

Figure 32. Installing 2-56 (Smaller) Standoffs in the Bottom Cover.

□ If you haven't done so already, remove the new heat sink from the paper wrapper. The side of the heat sink that will face the KX3 has been masked keep it free of the powder coating (see Figure 33). Remove the masking tape covering this area of the heat sink. The tape is strong. You can peel up one corner with a sharp tool and then pull the tape off of the metal as shown in the figure.

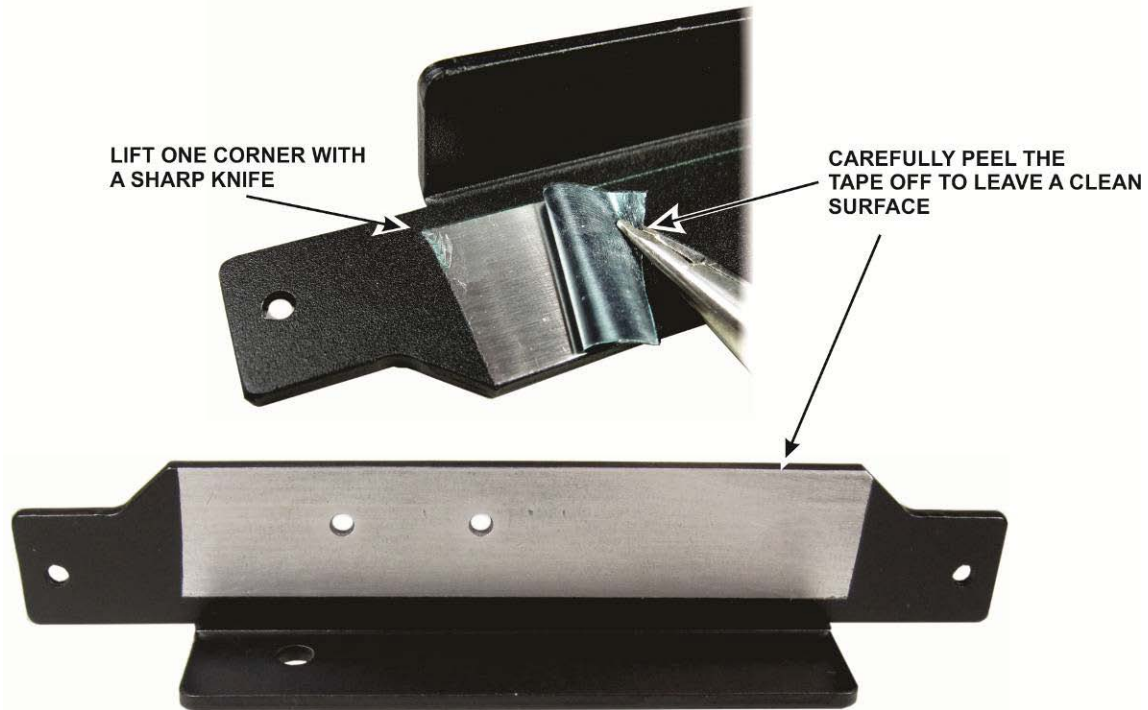

Figure 33. Removing Tape from the Heat Sink.

□ Lay the heat sink down on your work table as shown Figure 34 with the two 4-40 flat head screws in the holes as shown. The screw size is not important. They are there only to help you align the thermal pad over the bare metal area. (The figure shows two 3/8" {9.5 mm} screws.)

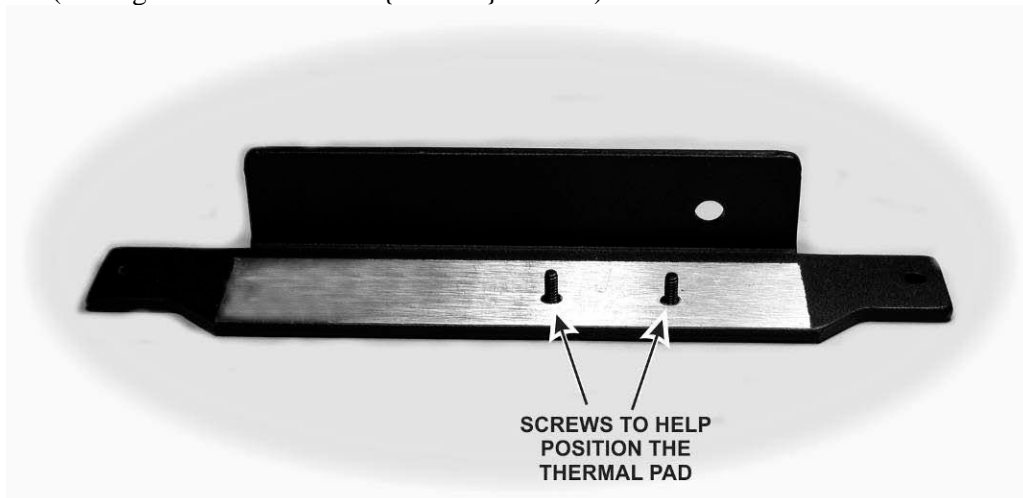

Figure 34. Heat Sink Ready for Thermal Pad.

☐ Locate the thermal pad and carefully separate the *clear* protective coating from one side. There are three layers: a clear plastic protective film, the very thin thermal pad itself, and a white plastic protective film. The three layers are shown in Figure 35. **Remove only the clear plastic protective film to expose the adhesive surface of the thin white thermal pad underneath.** A sharp knife is handy for separating the layers. Work carefully to avoid separating the very thin thermal pad from the white plastic underneath. The thermal pad wrinkles easily if it is allowed to separate from the white plastic and will not work properly unless it remains flat.

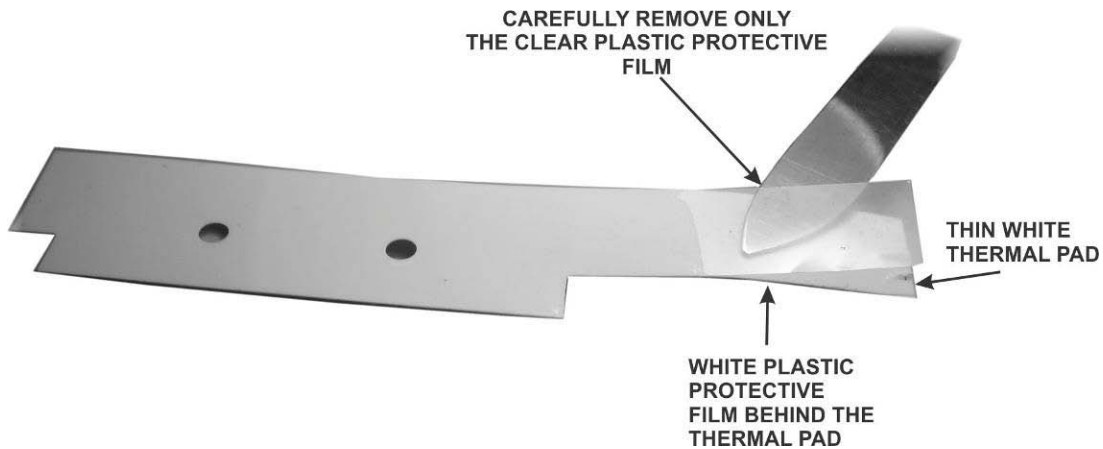

Figure 35. Preparing the Thermal Pad.

☐ Carefully position the thermal pad on the heat sink as shown in Figure 36. Be sure the thermal pad is against the metal and the white plastic protective film is facing upward. Rub the center area of the thermal pad to help it adhere to the metal. Remove the screws and return them to the proper parts envelope.

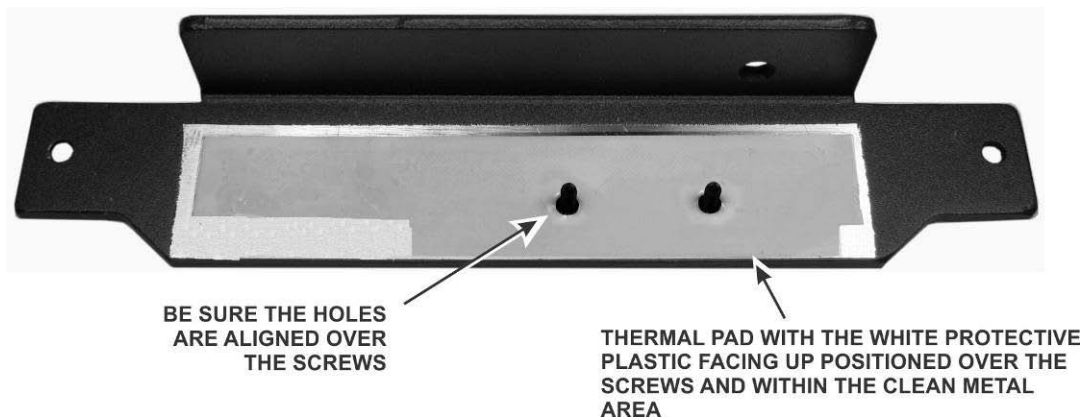

Figure 36. Placing the Thermal Pad on the Heat Sink.

Remove the clear plastic protective cover from the thermal pad as shown Figure 37. Be sure the thermal pad remains attached to the metal and does not fold or wrinkle.

⚠ Keep the exposed adhesive surface of the thermal pad clean.

CAREFULLY PEEL THE WHITE
PLASTIC PROTECTIVE COVER
OFF OF THE THERMAL PAD.
USE A SHARP KNIFE AS NEEDED
TO PICK UP ONE CORNER BUT
BE CAREFUL TO AVOID LIFTING
THE THERMAL PAD



Figure 37. Removing the Clear Plastic Protective Cover from the Heat Sink.

Place the KX3 bottom cover assembly upside down as shown in Figure 38. Attach the cover with the black flat head screws as shown. Carefully place the heat sink on the enclosure and secure it with the screws shown. The thermal pad presses against the powder coating on the bottom cover. Although the thermal pad is tacky, the heat sink can be moved as needed to align the screw holes.

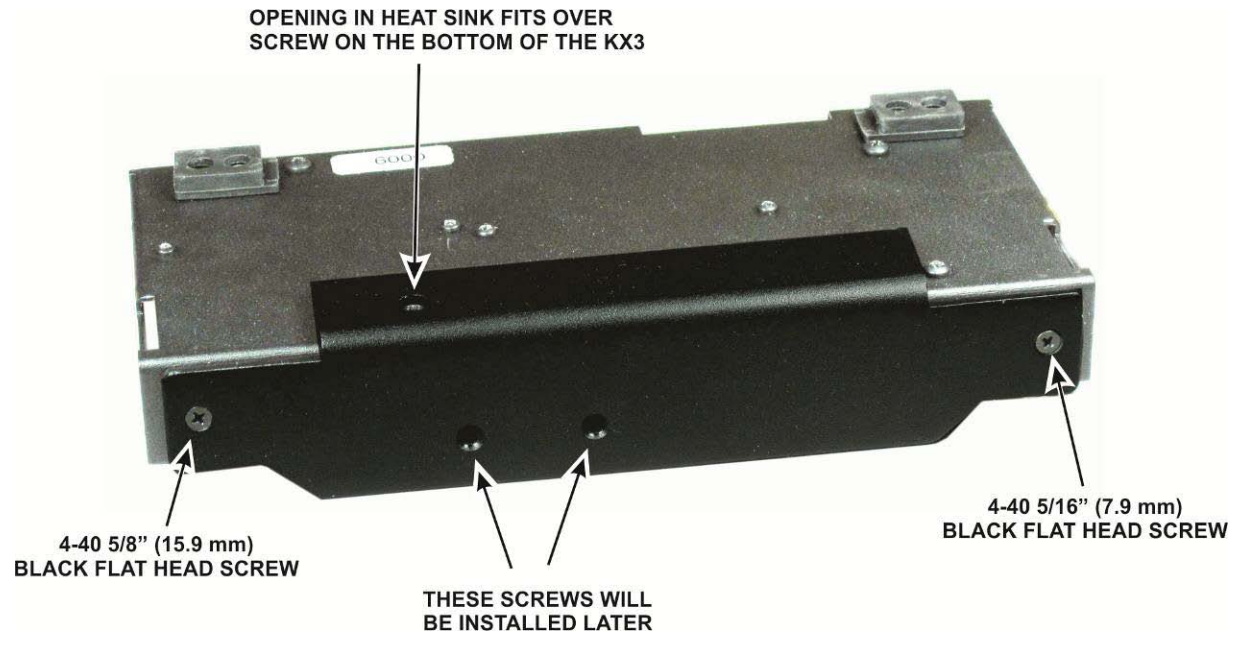

Figure 38. Mounting the Heat Sink on the Bottom Cover.

Locate the antenna connector assembly with the low-pass filter (LPF) attached and carefully slide the spacer over the cable and toroid and up onto the threaded portion of the connector (see Figure 39).

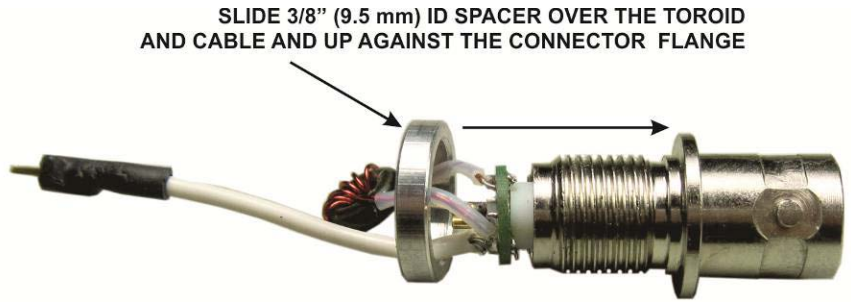

Figure 39. Putting the Spacer on the Antenna Connector.

□ Mount the antenna connector assembly in the largest hole in the bottom cover end plate as shown in Figure 40. Note that the hole has a flat side. Align it with the flat on the connector.

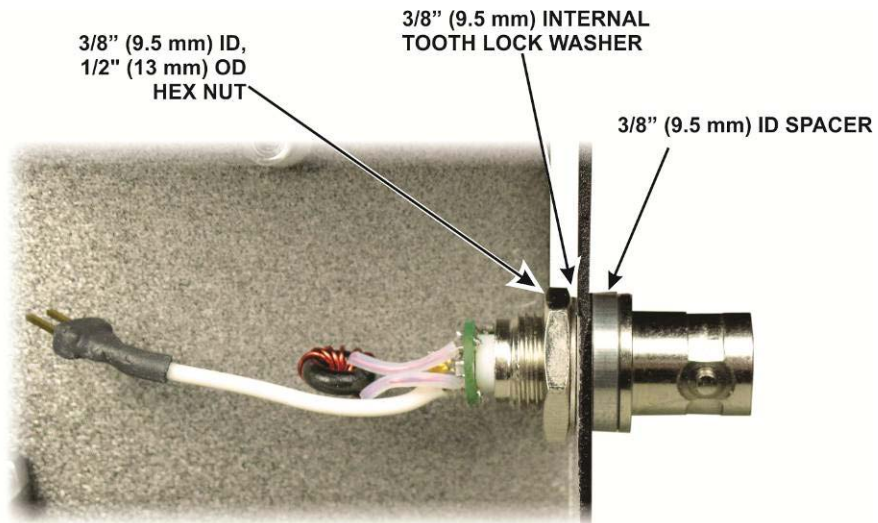

Figure 40. Antenna Connector Mounted on Bottom Cover.

□ Carefully bend the leads to position the toroid underneath the antenna connector as shown in Figure 41. **Be sure the toroid does not rest against the bottom cover.**

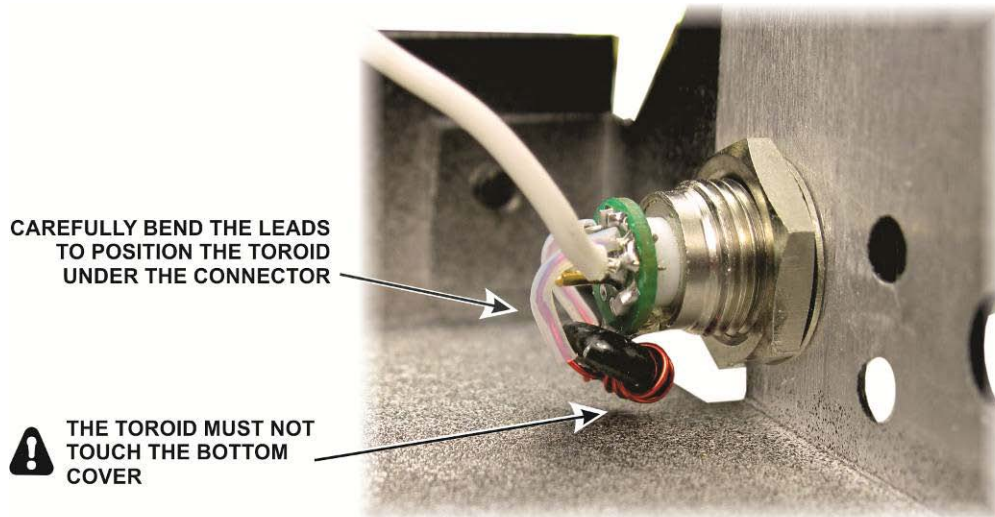

Figure 41. Positioning the LPF Toroid Under the Antenna Connector.

□ Taking ESD precautions remove the RF board from its protective envelope and mount the shield in the square outline on the pc board. Peel the protective back covering off of the shield and align the shield carefully with the outline on the RF board as shown in Figure 42. Press on the shield to ensure it is well adhered to the RF board.

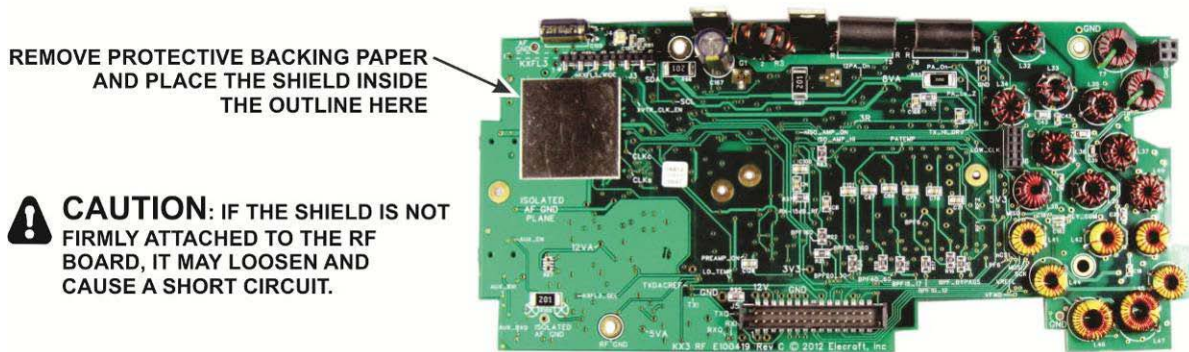

Figure 42. Installing the RF Board Shield.

□ Bend the wire attached to the antenna connector upward so it will be above the RF board after it is installed. Place the RF board in the bottom cover as shown in Figure 43. Put the end of the board with the shield into the bottom cover first so the connectors on the bottom of the board fit into the openings in the end of the cover. Bend the lead to the antenna connector up as shown. When the board is lying flat against the standoffs secure it with the hardware shown.

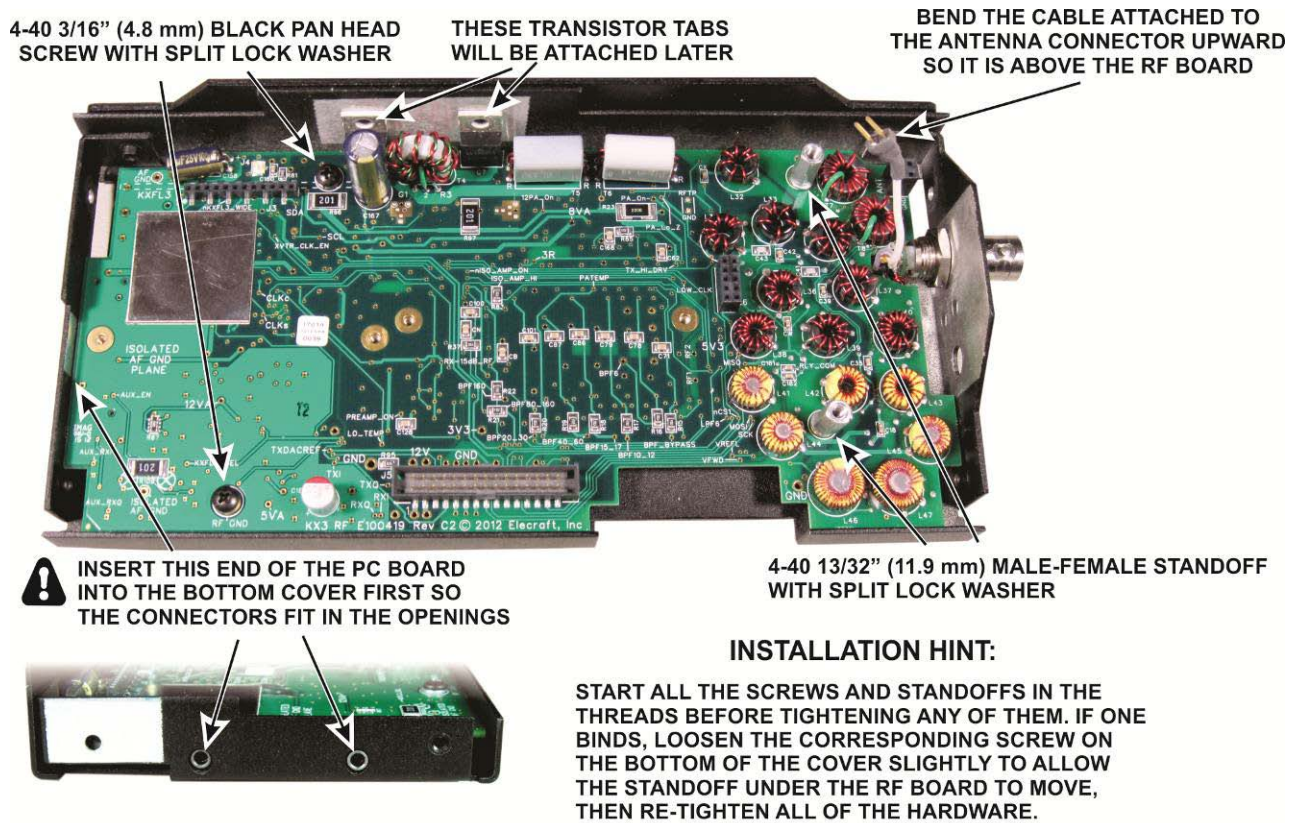

Figure 43. Installing RF Board in the Bottom Cover.

Check the spacing between transformer T7 and the standoff shown below. If they are touching, carefully push T7 away. There might not be as much space between them as shown. All that is required is that they are not in actual contact.

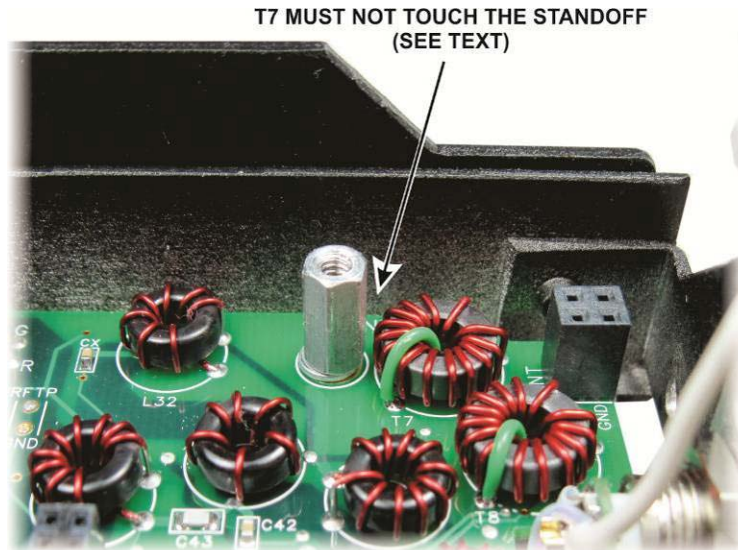

Figure 44. Checking T7 Clearance.

Thread 2-56 screws into the remaining four holes in the RF board as shown in Figure 45, make adjustments as necessary for them to fit just as you did in the previous step and then remove them. These screws will be replaced later to secure the battery holders.

**TEMPORARILY THREAD 2-56 5/16" (7.9 mm) ZINC FLAT HEAD SCREWS PART WAY TO ENSURE HOLES ARE ALIGNED.
REMOVE THE SCREWS WHEN FINISHED. THEY WILL BE USED TO INSTALL THE BATTERY HOLDERS LATER.**

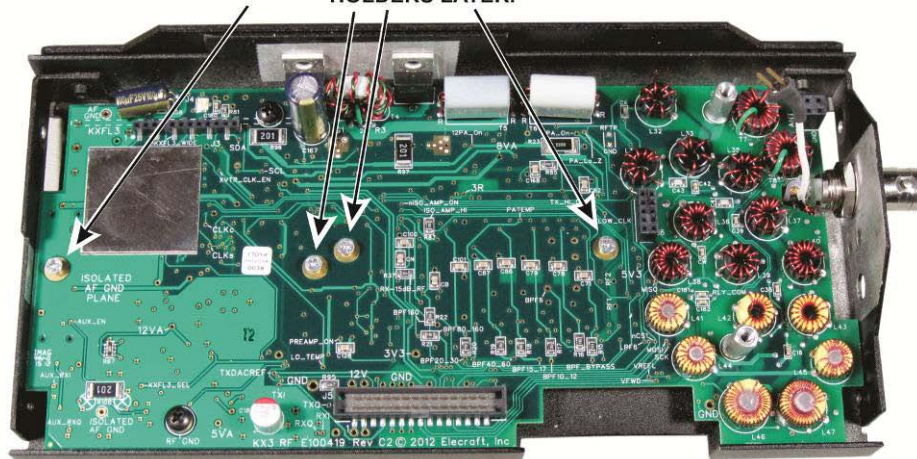

Figure 45. Checking the Alignment of the Battery Holder Standoffs.

Secure the tabs for the two transistors to the bottom cover as shown in Figure 46. The metal tabs on these transistors are at ground potential so there is no need to insulate them from the bottom cover, nor is a heat transfer compound such as silicon grease needed.

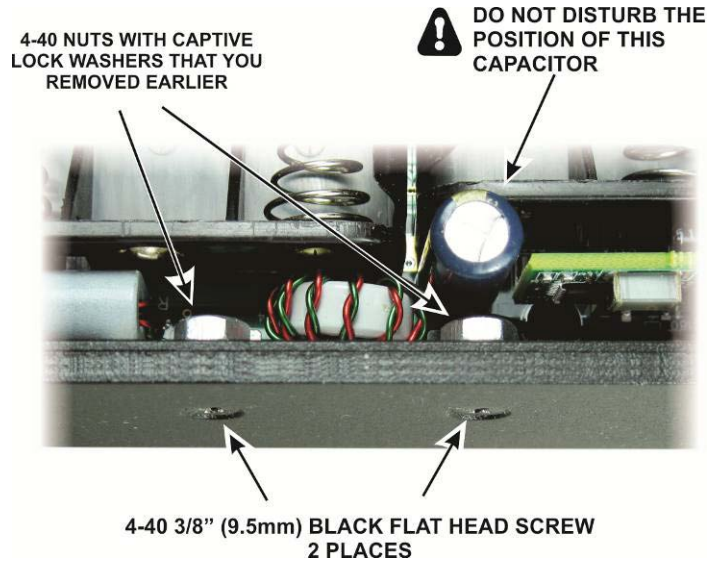

Figure 46. Securing the Tabs for Q6 and Q7 on the RF Board to the Bottom Cover.

Insert the plug in the hole next to the antenna connector as shown in Figure 47. The hole is not round, so the plug is a tight fit. The plug snaps in place.

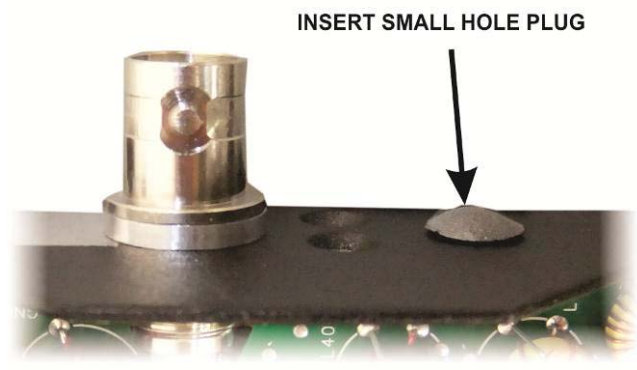

Figure 47. Installing the Hole Plug.

If you have the KXAT3 ATU option to install at this time, mount the KXAT3 board as shown in Figure 48 using the hardware provided with the KXAT3 option. Be especially careful to ensure that all the pins on both connectors engage with their opposites on the RF Board. It is normal for part of the length of the connector pins to be visible when the connectors are properly mated.

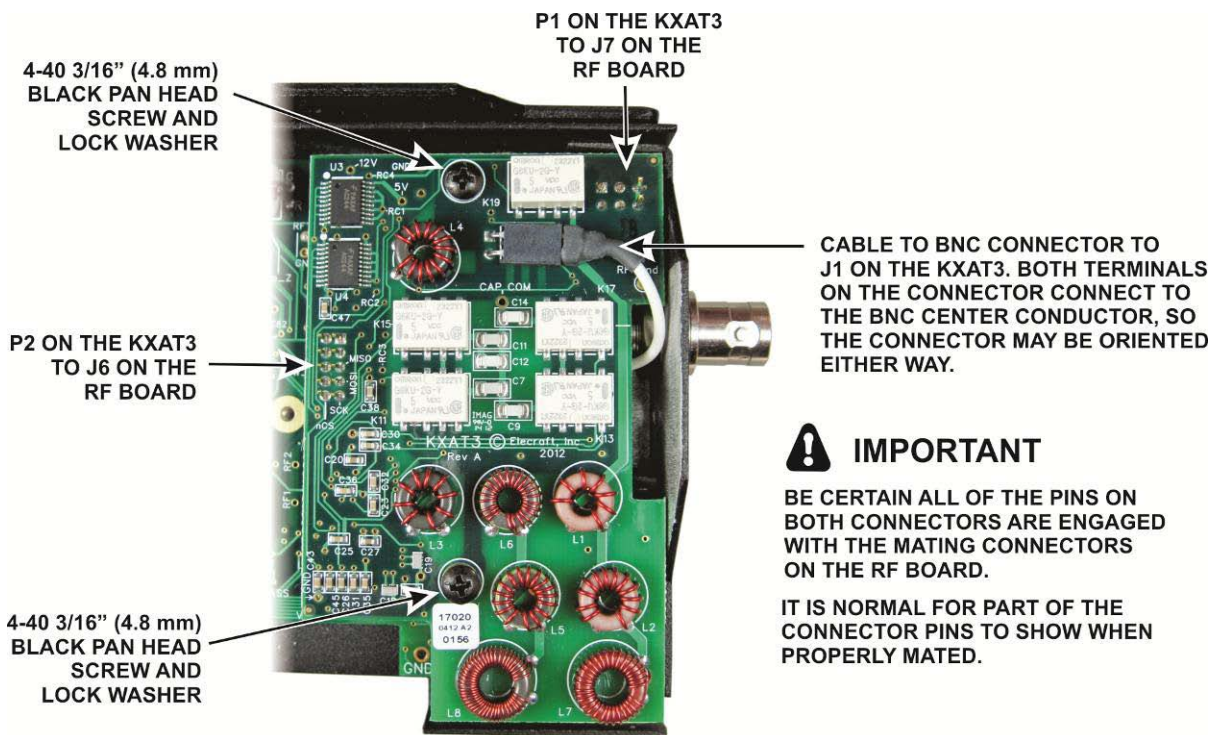

Figure 48. Installing the KXAT3 ATU.

If you did not install the KXAT3 in the previous step, plug the wire from the antenna connector into J7 on the RF board as shown in Figure 49. Be sure the connector is oriented so that both pins engage J7 on the side marked ANT.

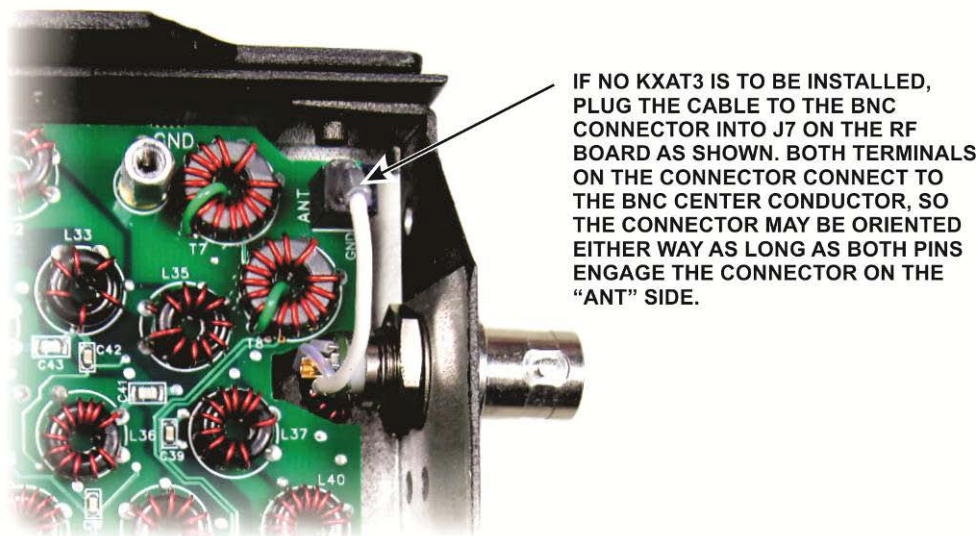

Figure 49. Connecting the Antenna Cable to the RF Board.

☐ If you have the KXFL3 filter option, install it as shown in Figure 50, otherwise skip this step. The connector for the KXFL3 board is at the opposite end of the RF board from the antenna connector and near the shield you installed on the RF board earlier.

- First loosen the screw at the end of the heat sink so the board does not strike it and insert it as shown with pin 1 of the KXFL3 board in the connector hole closest to the end of the KX3. Note that two holes in the female connector are not used. The KXFL3 board has only ten pins.
- Replace the screw through the bottom cover and heat sink so it passes through the hole in the KXFL3 board. It does not make electrical contact with the board. It is there to ensure the board cannot be dislodged by rough handling of the KX3. If the screw strikes the board instead of entering the hole, you have the KXFL3 plugged in incorrectly.

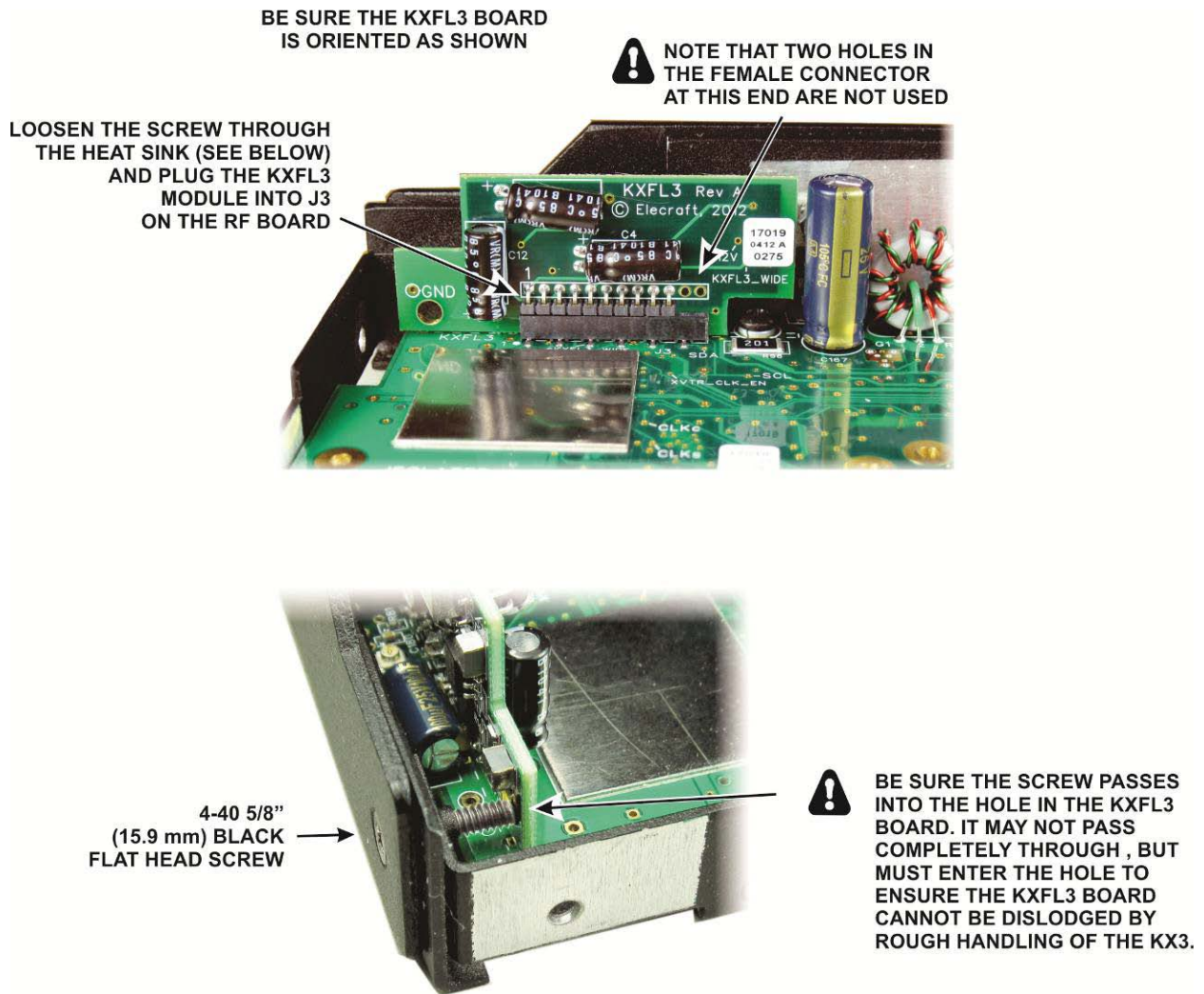

Figure 50. Installing the KXFL3.

□ Install the two battery holders as shown in Figure 51. Orient the holders and route the wires as shown. Press down on the holder while starting each screw and be sure you hold the screw vertically so it does not damage the first threads in the standoff beneath the RF board. It is normal for the screws to press against the sides of the battery holders.

⚠ CAUTION! Be certain the battery holders are installed so the wires are as shown below with the shrink-wrapped splices well clear of the multi-pin connector. It may be possible to reverse the holders so shrink-wrapped splices are jammed against the multipin connector. That would cause the splice to fail or break the insulation on the wires and cause a short circuit.

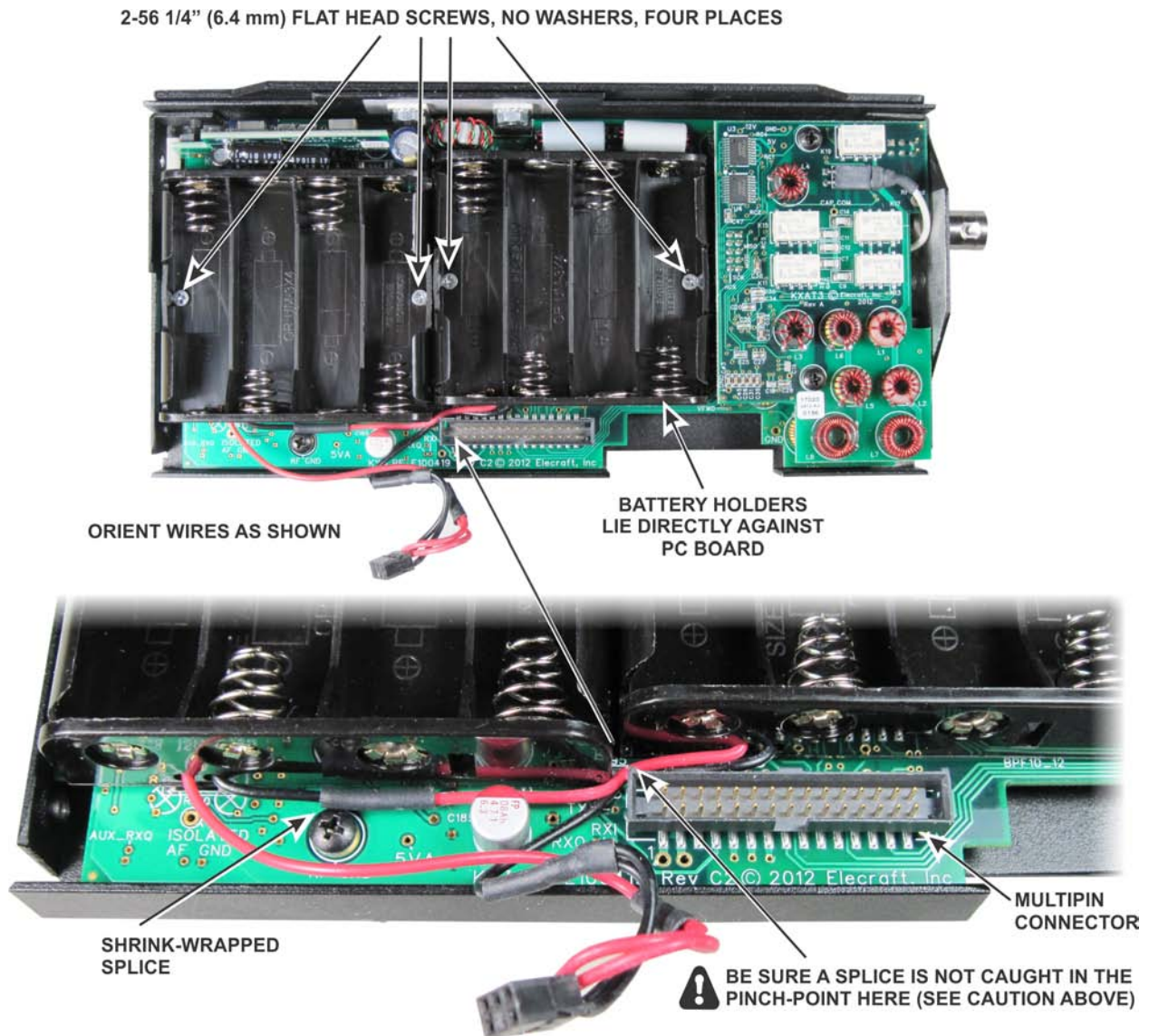
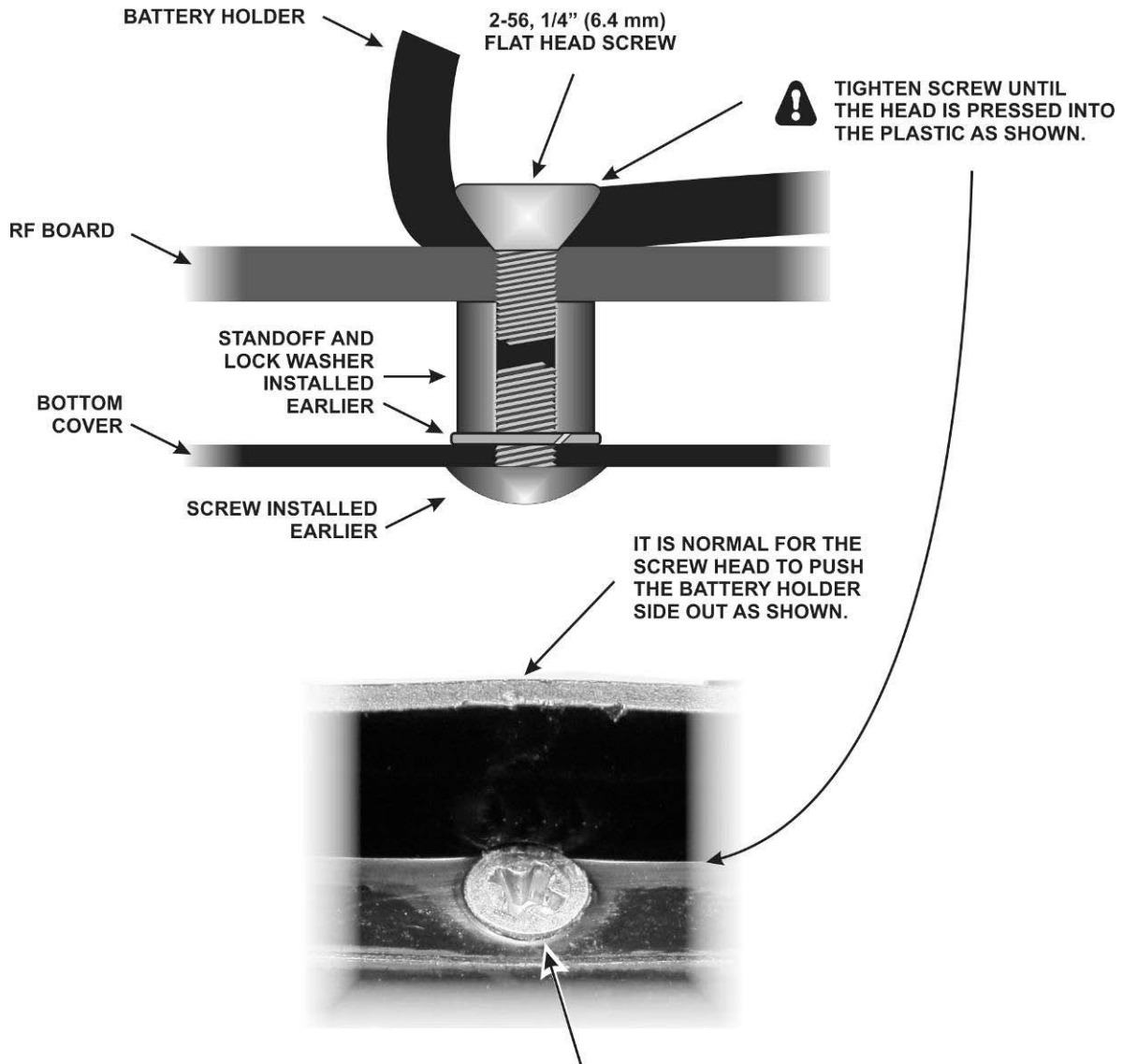

Figure 51. Installing the Battery Holders.

☐ Tighten all four screws that you just installed in the battery holders until the heads are sunk into the plastic as shown in Figure 52. You may need to stand the assembly on the heat sink and put a second screwdriver on the corresponding screw on the bottom cover to keep the standoff from turning while you tighten the screw in the battery holder.

⚠ CAUTION! Failing to tighten the battery holder screws as described may result in extensive damage to your KX3.



⚠ CAUTION! THE SCREW MUST BE TIGHTENED UNTIL THE HEAD SINKS INTO THE PLASTIC AS SHOWN, OTHERWISE IT CAN PRESS AGAINST AND BREAK THROUGH THE PLASTIC SHEATH ON THE CELL, CAUSING A SHORT TO GROUND THAT MAY RESULT IN EXTENSIVE DAMAGE TO YOUR KX3.

Figure 52. Final Tightening Battery Holder Screws.

Final Assembly

☐ Turn the bottom cover assembly over and install both tilt feet as shown in Figure 53. Do not tighten the thumb screw until the top cover assembly has been fitted. Without the thickness of the side panels on the top cover the screw will strike the RF pc board.

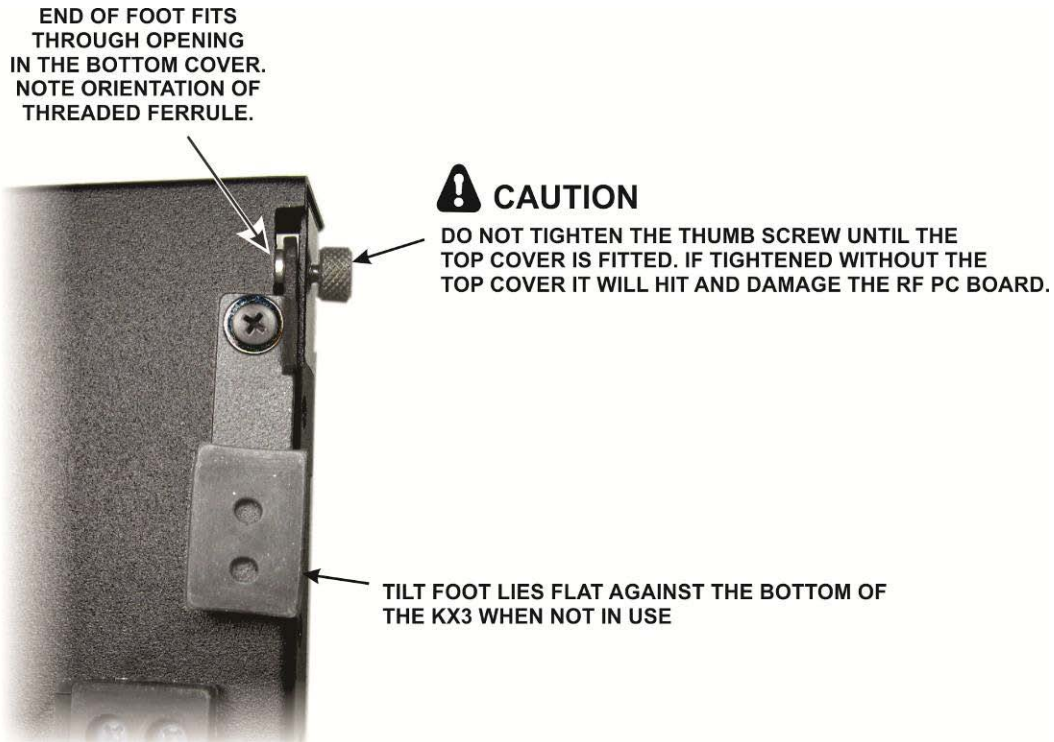

Figure 53. Installing the Tilt Feet.

☐ Fit the top and bottom covers together as shown in Figure 54. Be sure the battery cable is out of the way and not trapped between the covers. It will be installed later. Secure the covers with four thumb screws. Two of the screws are already in place holding the rear feet.



Figure 54. Test Fitting the Top and Bottom Covers Together.

□ Turn the KX3 over and check the gap between the place where the top cover folds under the bottom below the speaker and the bottom cover as shown in Figure 55. A gap as shown is critical to avoid the speaker vibrating the top cover against the bottom cover causing a buzzing sound. If needed, separate the top and bottom covers and adjust the fit as shown in Figure 56.

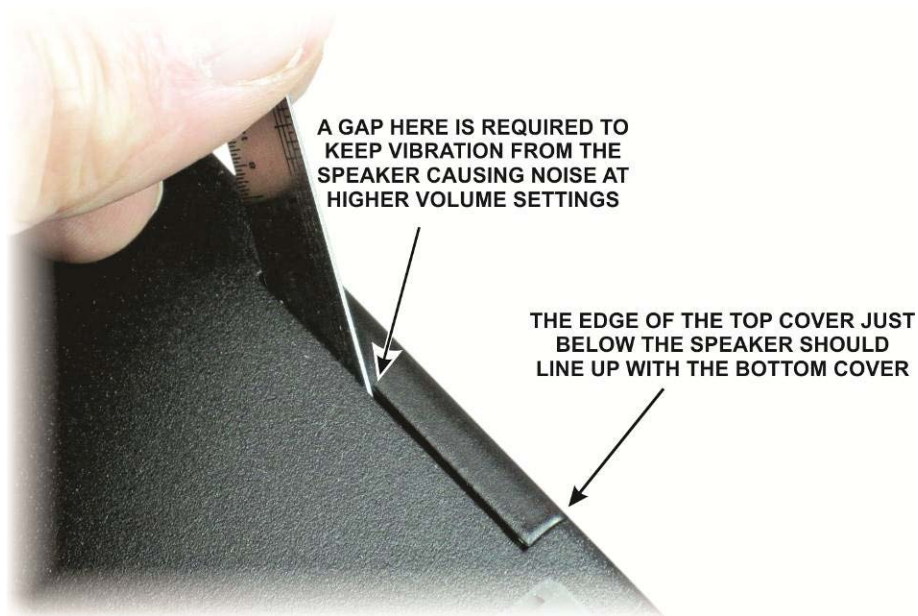
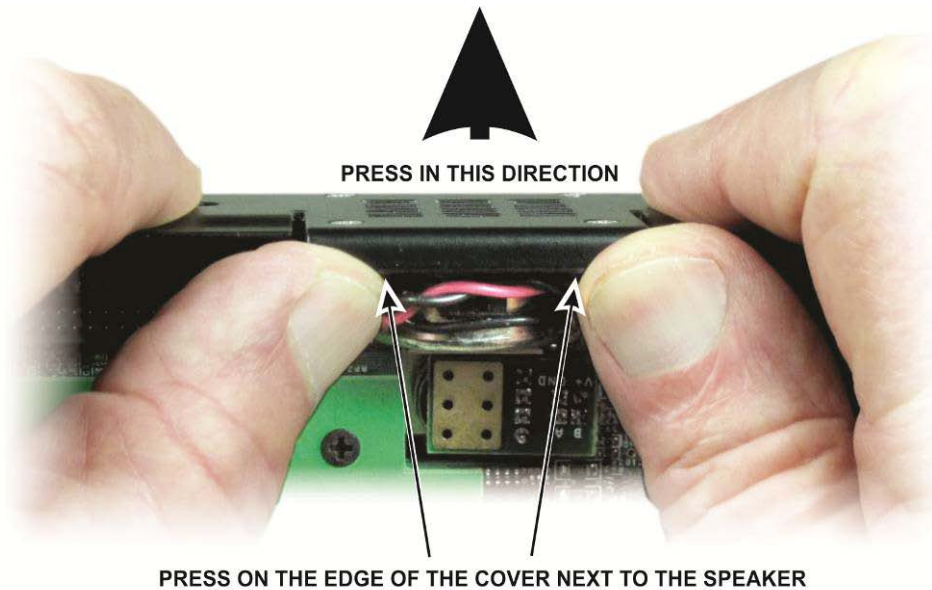

Figure 55. Checking the Cover Fit.



CAUTION: TO AVOID BENDING THE COVER TOO MUCH, DO NOT TRY TO MAKE THE ADJUSTMENT IN ONE TRY. WORK IN SMALL STEPS, CHECKING THE RESULTING GAP AFTER EACH ADJUSTMENT.

Figure 56. Adjusting the Cover Fit.

Separate the KX3 top and bottom covers. Set the bottom cover on its feet and locate the flex cable that will join the RF board to the CP board (see Figure 57).

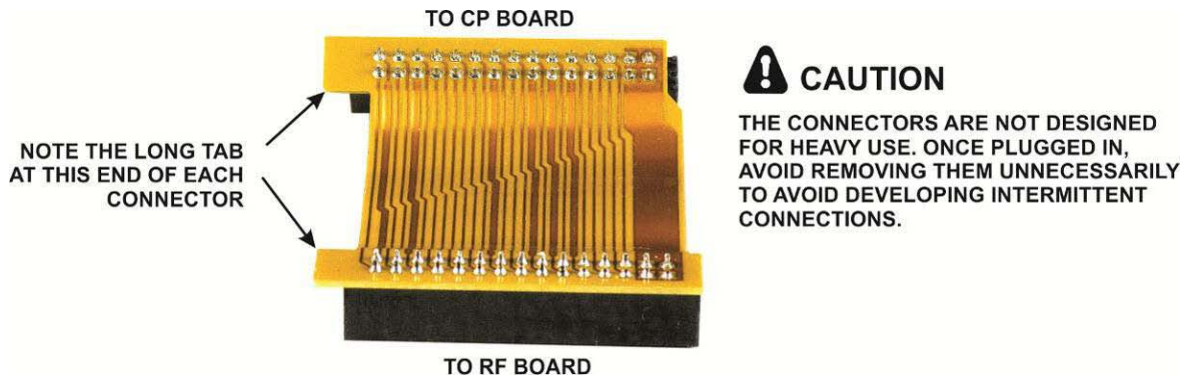

Figure 57. Flex Cable.

Plug the flex cable into P2 on the CP board as shown in Figure 58. Be sure it is oriented with the long tab on the cable toward the speaker as shown.

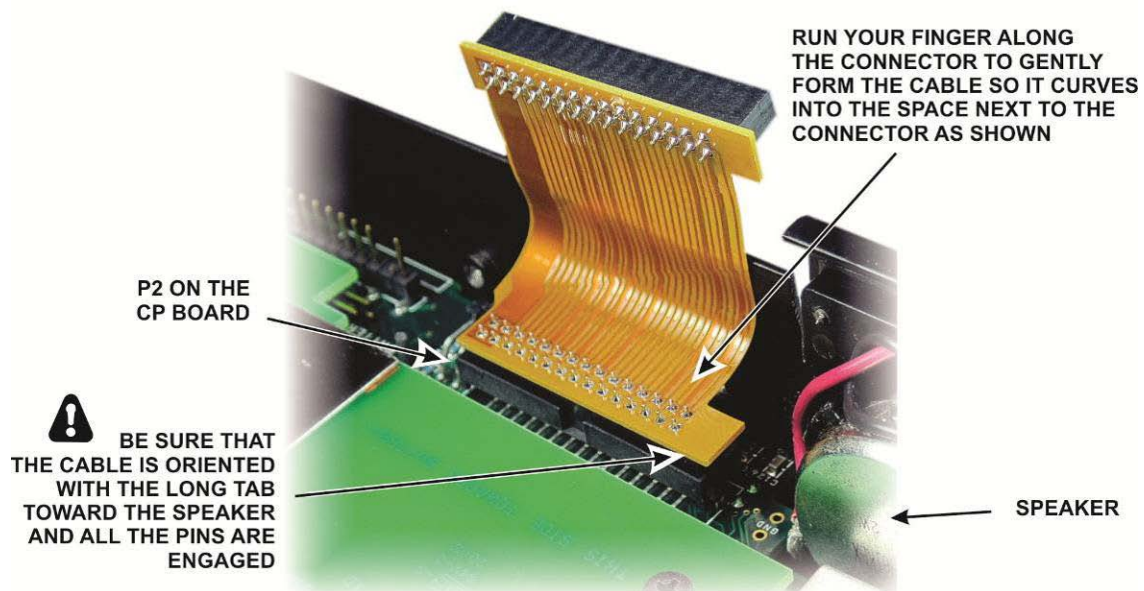

Figure 58. Plugging the Flex Cable into the CP Board.

Set the top cover assembly next to the bottom cover and connect the flex cable and battery cable as shown in Figure 59. Ensure the speaker cable is still routed over the speaker as shown so it won't be trapped between the battery holders and the CP board when the cover is closed.

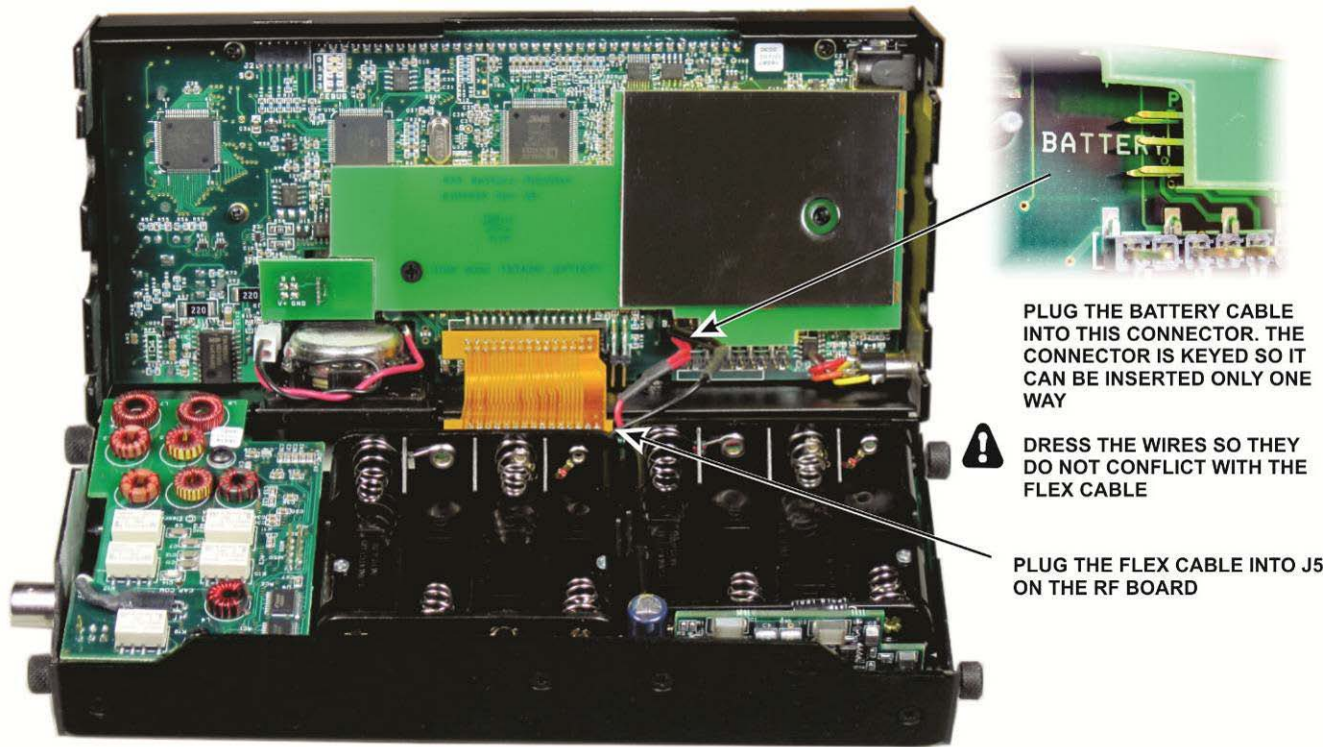

Figure 59. Connecting the Flex and Battery Cables.

☐ If you wish to install the internal battery, you may do so now. When installing the battery always inspect the sheath around each cell for damage. The sheath provides critical insulation to avoid short circuits. Many cells, especially single-use (not rechargeable) alkaline cells, have the entire cell casing connected to the positive terminal which is separated from the negative terminal at the bottom end of the cell by a thin insulator (see Figure 60). If the plastic sheath is damaged, the bottom spring contact in the battery holder can bridge the insulation, shorting the cell. The resulting heat can do extensive damage to the KX3. Damage to the sheath along the sides of the cells can also cause short circuits by touching the metal shield on the battery retainer. Refer to your owner's manual for more information about recommended battery types and battery care.

! CAUTION

NEVER USE A CELL WITH ANY DAMAGE TO THE PLASTIC SHEATH. THE CELL BELOW HAS HAD A LARGE SEGMENT OF THE SHEATH REMOVED TO SHOW THE CONSTRUCTION CLEARLY, BUT EVEN A SMALL TEAR ON THE SIDE OR AT THE BOTTOM CAN ALLOW A SHORT CIRCUIT TO OCCUR RESULTING IN SEVERE DAMAGE TO YOUR EQUIPMENT.

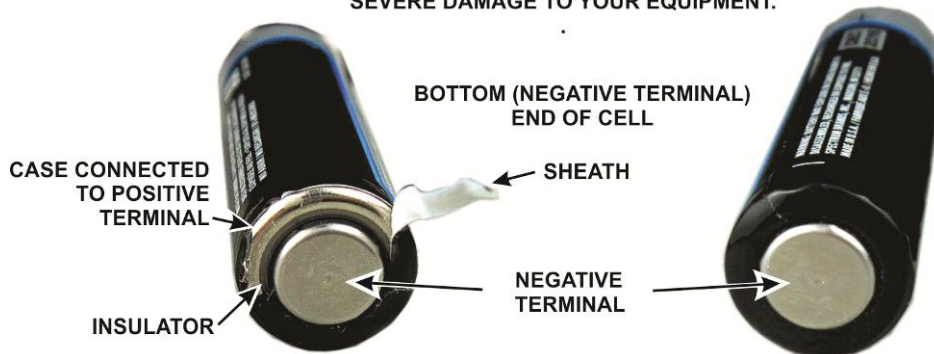

Figure 60. Checking Battery Cells.

☐ Close the top and bottom covers and secure them with thumb screws as shown in Figure 61.

⚠ CAUTION: As you close the covers ensure that the flex cable folds into the space next to the CP board connector as shown. Do not allow it to fold toward the battery holders. If the flex cable resists pushing into the space next to the CP board connector, use your finger to gently crease it along the edge of the connector as shown in Figure 58.

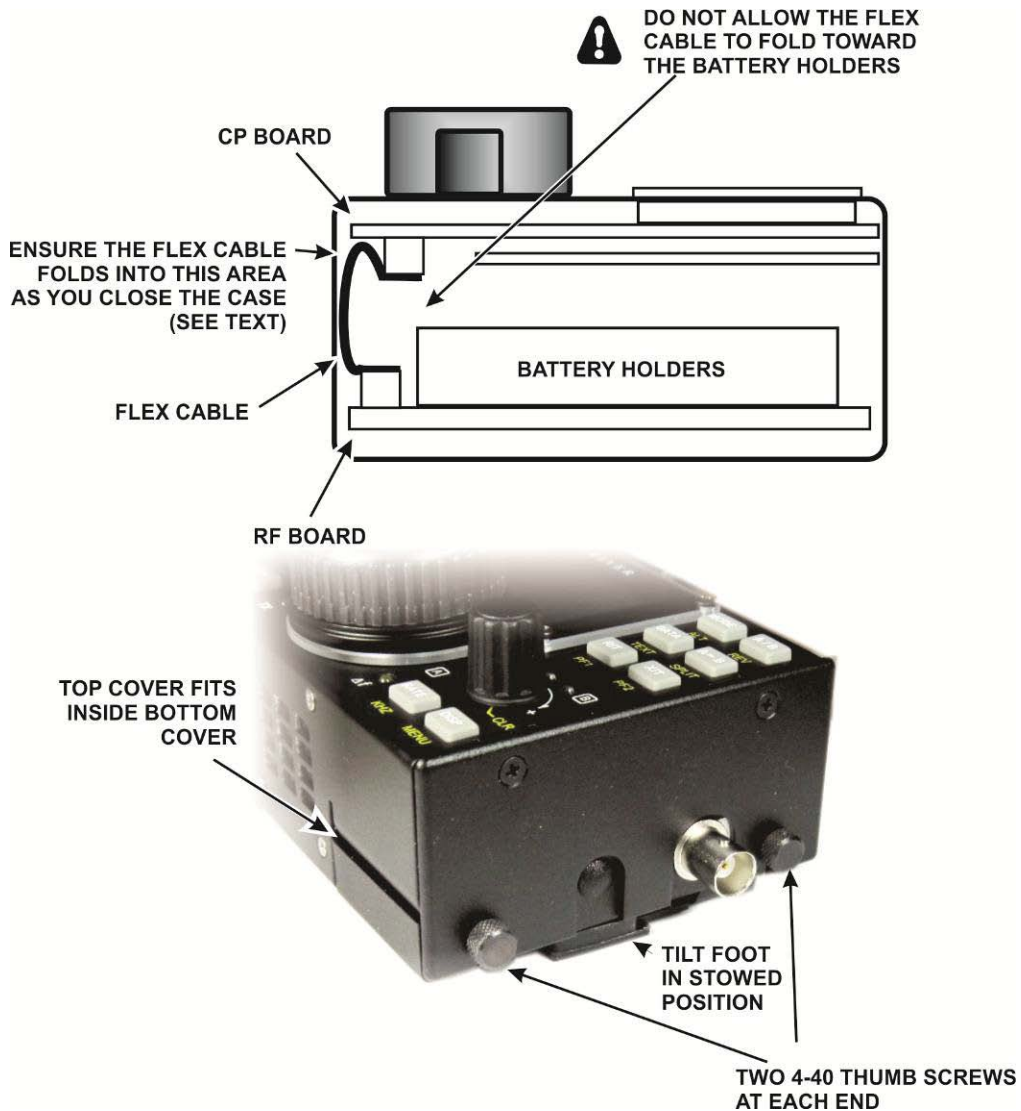

Figure 61. Closing the KX3.

⚠ Be sure the thumb screws are loose when adjusting the tilt legs to position your KX3. The thumb screws thread into the legs, and forcing a leg into position without loosening the thumb screw may tighten the thumb screw so much it becomes very difficult to loosen.

Setup and Operation

KX3 Setup and Operation instructions are included in the KX3 Owner's Manual supplied with your kit. If you purchased the KXBC3 NiMH Battery Charger and Real Time clock option, Setup and Operation instructions for the charger and real-time clock are included in the KXBC3 manual supplied.

IMPORTANT!

1. **If you installed the KXAT3 or KXFL3 options you must enable them. See *Option Module Enables* in your KX3 Owner's manual. Be sure to cycle the KX3 power off, then on again after enabling the modules.**
2. **If you installed the KXBC3 Battery Charger and Real Time Clock option, perform the *Initial Tests* described in the manual that came with the KXBC3.**
3. **If you received the optional KXFL3 filter with your kit, you do not need to perform the Receiver Sideband alignment procedure referenced in the Owner's manual and described in detail in the KXFL3 option manual. That procedure was done for you at the factory.**
4. **If you did NOT install the optional KXFL3 filter, you must disable the KXFL3 in the menu; set *RX XFIL* to *NOT INST*. If you do not disable the filter, you will lose receive audio at narrower filter settings.**

Appendix A - Illustrated Parts List

Your kit contains a number of envelopes, boxes and packages of parts. Check the contents of each one carefully against the following lists. See *Screws* and *Standoffs* on page 6 for information help determining the correct lengths of the screws and standoffs.

You may find extra screws, nuts and other small parts provided in case you lose one. They may be in a separate bag or mixed in with the others.



Printed Circuit Boards

Each board is packaged in its own ESD-safe bag identified by the part numbers shown below. The photographs are provided to help you identify each board. You may find that some of the components or component locations on the boards you receive are slightly different from those shown.

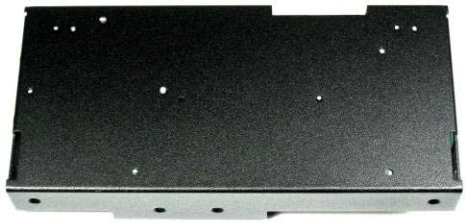
Top and Bottom Covers

ILLUSTRATION	DESCRIPTION	QTY.	ELECRAFT PART NO.
	Top Cover	1	E100404SS
	Bottom Cover	1	E100399



Side Panels - Bag E850535

ILLUSTRATION	DESCRIPTION	QTY.	ELECRAFT PART NO.
	Left Side Panel	1	E100400SS
	Right Side Panel	1	E100401



PCB Assemblies

CAUTION

Leave the PCB assemblies in their ESD-safe packaging until needed. Take ESD precautions when you do remove them, and be careful not to damage components on either side of the circuit boards when handling them.

ILLUSTRATION	DESCRIPTION	QTY.	ELECRAFT PART NO.
	<p>CP Board Assembly</p> <p>Note: This assembly includes a jack with associated mounting nut threaded onto it. The nut will be used when installing the board.</p>	1	E850441
	RF Board Assembly	1	E850484

Encoder Bag (E850547):

ILLUSTRATION	DESCRIPTION	QTY.	ELECRAFT PART NO.
	VFO Encoder Assembly	1	E850575
	Hex Nut (One nut may be supplied mounted on the encoder)	2	E700125
	Lock Washer (May be supplied on the encoder)	1	E700285



KXBC3/RET Hardware Envelope (E850558):



The KXBC3/RET hardware envelope provides the parts needed to install either the standard battery retainer or the KXBC3 Battery Charger and Real Time Clock option. If the KXBC3 is installed it replaces the standard battery retainer.

ILLUSTRATION	DESCRIPTION	QTY.	ELECRAFT PART NO.
	2-56 5/32" (4.0 mm) Black Pan Head Screw	1	E700170
	4-40 3/16" (4.8 mm) Black Flat Head Screw	2	E700173
	#4 Lock Washer, Split Ring	1	E700004
	4-40 3/16" (4.8 mm) Nylon Standoff	1	E700263

Front Panel (Top Cover) Hardware (E850532):

ILLUSTRATION	DESCRIPTION	QTY.	ELECRAFT PART NO.
	2-56 1/4" (6.4 mm) Black Pan Head Screw	7	E700171
	4-40 3/16" (4.8 mm) Black Flat Head Screw	5	E700173
	2-56 9/32" (7.2 mm) Flat Head Screw	4	E700277
	#2 Lock Washer, Split Ring	8	E700123
	#4 Lock Washer, Split Ring	2	E700004
	2-56 5/16" (7.9 mm) F-F Standoff	4	E700122
	4-40 5/16" (7.9 mm) F-F Standoff	1	E700121
	2-56 3/16" (4.8 mm) M-F Standoff	1	E700271
	4-40 3/16" (4.8 mm) M-F Standoff	1	E700078

Rear Panel (Bottom Cover) Hardware E850533

ILLUSTRATION	DESCRIPTION	QTY.	ELECRAFT PART NO.
	4-40 3/16" (4.8 mm) Black Pan Head Screw	6	E700172
	4-40 1/4" (6.4 mm) Black Nylon Pan Head Screw	6	E700282
	2-56 5/32" (4.0 mm) Black Pan Head Screw	4	E700170
	4-40 3/8" (9.5 mm) Black Flat Head Screw	2	E700176
	4-40 5/8" (15.9 mm) Black Flat Head Screw	1	E700307
	4-40 5/16" (7.9 mm) Black Flat Head Screw	1	E700249
	2-56 1/4" (6.4 mm) Zinc Flat Head Screw	4	E700259
	#2 Lock Washer, Split Ring	4	E700123
	#4 Lock Washer, Split Ring	8	E700004
	#4 Fiber Washer	2	E700031
	2-56 3/16" (4.8 mm) Standoff	4	E700257
	4-40 3/16" (4.8 mm) Standoff	4	E700237
	4-40 13/32" (10.3 mm) M-F Standoff	2	E700258
	4-40 Nut with Captive Star Washer	2	E700169
	4-40 Thumb Screws	4	E700050
	3/8" (9.5 mm) Internal Tooth Lock Washer	1	E700285
	3/8" (9.5 mm) Hex Nut	1	E700125
	Spacer 3/8" (9.5 mm) ID.	1	E700283



Misc

ILLUSTRATION	DESCRIPTION	QTY.	ELECRAFT PART NO.
	VFO Knob	1	E980181
	VFO Knob Rubber Finger Grip	1	E980182
	Felt Washer	1	E700033
	Small Encoder Knob Bag (contains 4 small encoder knobs).	1	E850528
	KX3 Wrench Set	1	E850503
	RF Board Shield	1	E100443
	Power Cord		E850524
	Bezel	1	E100403
	Speaker Note that the color of the wires may vary.	1	E850487
	Speaker Grille with Attached Gasket	1	E100441
	Rubber Foot	4	E980185

ILLUSTRATION	DESCRIPTION	QTY.	ELECRAFT PART NO.
	Serial Number Label (In envelope)	1	E850523
	Tilt Foot, Left	1	E980183
	Tilt Foot, Right	1	E980184
	KX3 Antenna Connector Assembly with LPF	1	E850552
	Battery Holder Assembly	1	E850519
	Flex Cable	1	E980219
	Enhanced Heat Sink (wrapped)	1	E850677
	<p>Thermal Pad</p> <p> Handle with Care. Do not remove the protective film from either side until instructed to do so.</p>	1	E100546
	Hole Plug	1	E700239
	<p>Data Cable Assembly: Either RS232 or USB, chosen at the time order is placed.</p> <p>NOTE: If you chose the KXSER cable, the bag may be marked E850369.</p>	1	<p>KXUSB (USB)</p> <p>Or</p> <p>KXSER (RS232)</p>

Note: The following parts are not supplied if you purchased the KXBC3 Battery Charger/Real Time Clock option with your Kit. The KXBC3 replaces the battery retainer so these components are not needed.

KX3RET BATTERY RETAINER COMPONENTS

ILLUSTRATION	DESCRIPTION	QTY.	ELECRAFT PART NO.
	Battery Retainer	1	E100440
	CP Board Shield	1	E100444