



ELECRAFT® KX3

ULTRA-PORTABLE 160-6 METER, ALL-MODE TRANSCEIVER

OWNER'S MANUAL

Revision C2, August 13, 2013

Copyright © 2013, Elecraft, Inc.

All Rights Reserved

Contents

Introduction	3	Transmit Noise Gate	21
Key to Symbols and Text Styles.....	3	Transmit Inhibit and External PTT	21
Installation	4	Cross-Mode Operation and CW-in-SSB	21
Operating Position	4	Transverter Bands	21
Power Supply	4	Special VFO B Displays	22
CW Key/Keyer Paddle	4	Extended Single Sideband (ESSB)	22
Headphones and Speakers	5	Internal Batteries	23
Microphone.....	5	VFO Friction Adjustment	24
Computer/Control Port (ACC1)	5	Options and Accessories	25
Keyline Out and GPIO (ACC2).....	5	Firmware Upgrades	25
Quadrature Outputs (RX I/Q)	5	SDR Applications	26
Antennas	6	Remote Control of the KX3.....	28
Grounding and ESD Protection	6	Configuration	29
Control Panel Reference	7	Option Module Enables	29
Display (LCD)	8	Menu Settings	29
Basic Operation.....	9	Calibration.....	31
Getting Started	9	Reference Frequency	31
Band Selection	10	Receive Sideband.....	32
Mode Selection	10	Transmit Bias	32
VFOs A and B	11	Transmit Gain	33
Incremental Tuning (RIT and XIT)	11	Transmit Carrier.....	34
Special VFO B Displays.....	11	Transmit Sideband	34
Receive Settings	12	Menu Functions	35
Transmit Settings.....	14	Troubleshooting	42
Transmit and ATU Control.....	14	Parameter Initialization (EEINIT)	44
Voice Modes (SSB, AM, FM).....	15	Error Messages (ERR nnn)	45
CW Mode	16	Theory Of Operation	47
Advanced Operating Features	17	RF Board.....	47
Frequency Memories	17	Control Panel (CP) Board.....	48
Scanning	17	KX3 Block Diagram	49
Data Modes	18	Glossary of Selected Terms	50
Text Decode And Display	19	Specifications	52
Programmable Function Switches	19	Customer Service and Support	53
Split and XIT	19	Index	54
Audio Effects	20		
Dual Watch	20		
Receive Audio Equalization (RX EQ).....	20		
Transmit Audio Equalization (TX EQ)	20		
SSB/CW VFO Offset.....	21		
Digital Voice Recorder (DVR).....	21		

Introduction

On behalf of our entire design team, we'd like to thank you for choosing the Elecraft KX3.

The KX3 is a compact, 160-6 meter, all-mode transceiver that's ideal for both new and experienced operators. Its unique features meet the requirements for home station use, portable, mobile, and even hand-held operation.

Since the KX3 is a software-defined-radio (SDR), you'll be able to extend its capabilities using computer applications, and add new features via free firmware upgrades. But the KX3 is also the only compact transceiver that combines the flexibility of an SDR with a full-size front panel and display, allowing operation with or without a computer.









Despite its small size, the KX3 can be configured as a fully self-contained amateur station, with an internal antenna tuner, battery charger, 2 meter module, and attached CW keyer paddle. These options can be added at any time. Current drain is also very low for a full-featured transceiver, reflecting our commitment to field operation. For mobile and home use, you can boost the KX3's output to 100 watts with the optional KXPA100 amplifier.

When it's time to take on the challenge and adventure of amateur radio, your KX3 will be ready.

73,

Wayne, N6KR
Eric, WA6HHQ

Key to Symbols and Text Styles

	Important – read carefully
	Operating tip
LSB	Display icon or text
	Enter keypad function
	Lock indicator (applies to VFO or menu parameter)
	Tap switch function (labeled <i>on</i> a switch)
	Hold switch function (labeled <i>below</i> a switch; hold for about 1/2 second)
	Function of a rotary control (knob)
	Tap switch function of a rotary control (labeled <i>above</i> a knob)
	Hold switch function of rotary control (labeled <i>below</i> a knob; hold for 1/2 second)
BKLIGHT	Menu entry

Installation

⚠ CAUTION

- **Be careful when plugging in cables.** Avoid applying sideways pressure that might damage the KX3's left-side jacks.
- **Avoid operating in wet conditions** (rain, snow, spray, etc.). The KX3 is not waterproof.
- **Avoid operating at very high temperatures.**
- **The KX3 can be damaged by electrostatic discharge (ESD).** Prior to opening the case, touch a grounded, unpainted metal surface.

Operating Position

All controls are located on the top of the KX3's enclosure. This provides ample space for controls and display, despite the transceiver's small size.

Tilt legs are provided in the back to position the controls and display for ease of use, as shown below. **Loosen the two rear thumbscrews before adjusting the legs. Tighten them afterwards.**

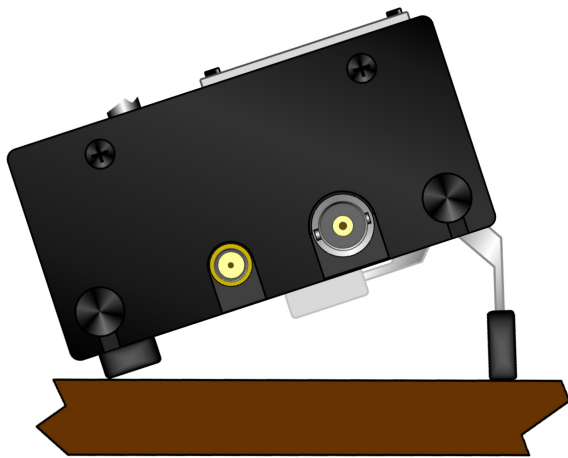

⚠ **To open the enclosure, follow the instructions on pg. 23 (Internal Batteries). Use only the method shown.**

i The KX3 can be conveniently operated with one hand, in a manner similar to writing in a notebook. If you're right-handed, rotate the radio slightly counter-clockwise (see cover illustration). If you're left-handed, rotate the KX3 clockwise.

Power Supply

For fixed-station use, a low-noise 12-14 VDC power supply or battery is recommended. (See *linear* and *switching power supplies* in the **Glossary**, pg. 50.) For lightweight portable operation, the KX3's internal 8-AA-cell battery pack can be used. See **Internal Batteries**, pg. 23.

⚠ **Maximum power output varies with supply voltage and other parameters. For full power (10+ watts on most bands), use 12-14 V.**

Connect an external power supply or battery to the 9-15 VDC jack (see illustration below). **The center pin is (+).** A 2.1-mm power plug is required (Switchcraft S760 or equivalent). On the supplied power cable assembly, the wire with the **white stripe** is (+). Trim the cable to the desired length.

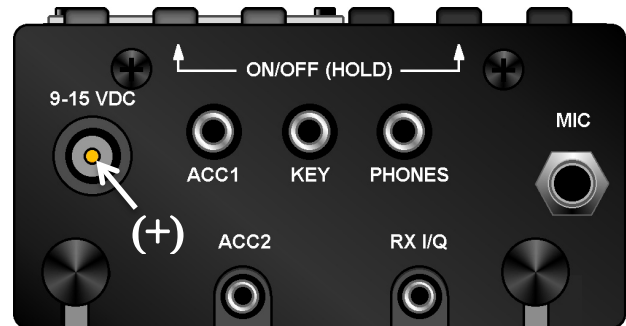

CW Key/Keyer Paddle

The KX3 has two CW keying inputs:

KEY Jack: This stereo 3.5 mm jack on the left side can be used with any hand key, keyer paddle, or other keying device, as selected by the *CW KEY1* menu entry (see **Using the Menu**, pg. 9).

⚠ **A stereo plug is required at the KEY jack, even if only the tip contact is being used, as with a hand key.**

KXPD3 Keyer Paddle: The KXPD3 is an optional high-quality keyer paddle that attaches at the front of the KX3 via two thumb screws. The dot and dash paddles can be electrically reversed or configured as a hand key using the *CW KEY2* menu entry. Allen wrenches are supplied for contact adjustment.

⚠ Avoid using bulky connectors or adapters that could put excessive stress on side-panel jacks. Lightweight cables, preferably with right-angle plugs, are strongly recommended.

Headphones and Speakers

The 3.5-mm **PHONES** jack, on the left side panel, accommodates mono or stereo headphones. You can also plug in one or two amplified (or *powered*) external speakers here. Mono or stereo plugs can be used. Stereo allows the use of *audio effects*, providing an enhanced listening experience (pg. 29).

The KX3 includes a small built-in speaker for use in quiet operating environments. Plugging in headphones disables the speaker and its amplifier. (This is an easy way to extend battery life.)

Mobile installations: The interior of most vehicles is too noisy for use with the KX3's built-in speaker. One or two amplified mobile speakers can be plugged into the **PHONES** jack, or you can connect this jack to your car stereo's AUX input. Another alternative is to use a device that retransmits the KX3's audio output in the FM broadcast band.

Microphone

The **MIC** jack is compatible with the Elecraft MH3 hand mic, which provides PTT as well as VFO UP/DN buttons. For the MH3, set the *MIC BIAS* menu entry to **ON**, and *MIC BTN* to **PTT UP.DN**.



MH3 Mic Pinout

- Sleeve:** Shield
- Ring2:** Logic ground
- Ring1:** PTT/UP/DN
- Tip:** Mic audio

Using other microphones and headsets: The KX3 is compatible with many headset-mics that have separate 3.5-mm plugs for mic audio and receive audio. You can also use some “mini” mics intended to plug directly into a laptop computer. Refer to the *MIC BIAS* and *MIC BTN* menu entries to set up the KX3 for use with your mic or headset.

Computer/Control Port (ACC1)

The 3.5-mm stereo **ACC1** jack allows firmware updates, configuration, and remote control of the KX3 via a computer. The jack can be connected to a computer's USB port via the Elecraft model **KXUSB** cable, or to an RS232 port via the model **KXSER** cable. (The jack's *tip* connection is RX data from the computer. *Ring* is TX data to the PC.)

Elecraft provides two KX3 configuration programs:

KX3 Utility is required for KX3 configuration and firmware updates (pg. 25). It also provides a CW/data terminal function.

Our **K3 Memory** PC application can be used to set up frequency memories more easily than with the radio's memory-store function.

Many logging, contesting, and control programs are available from third parties. If the KX3 is not specifically supported by a given program, try selecting **Elecraft K3** or **K2**.

Keyline Out and GPIO (ACC2)

The 2.5-mm stereo **ACC2** jack provides a *keyline* output (*ring* contact) and a general-purpose 3-volt logic signal (*tip* contact).

The keyline output goes low during transmit, and can be used for transmit/receive switching of linear amplifiers and transverters. For keyline voltage and current limits, see **Specifications**.

The general-purpose signal, GPIO, can be set up for various equipment control functions. For example, it can send band-change information to Elecraft XV-series transverters. See the *ACC2 IO* menu entry for a full list of uses for this signal, as well as hardware interface requirements.

Quadrature Outputs (RX I/Q)

The 2.5-mm **RX I/Q** jack provides quadrature outputs from the receive mixer (I=in-phase, Q=quadrature). These outputs can be used with computer-based *software-defined radio* (SDR) programs to extend the capabilities of the KX3. For example, a *spectral display* application can give you a graphic view of signals across a range of frequencies. See **SDR Applications** (pg. 26).

Antennas

You can use any resonant antenna having a 50-ohm (approximate) load impedance with the KX3. Examples can be found in the *ARRL Antenna Handbook* and other sources. A simple inverted “V” or dipole can be very effective.

Antenna jacks: The BNC antenna jack, identified at right, is used on 160-6 m. The SMA jack shown is supplied with the optional **KX3-2M** module (pg. 25). The basic KX3 has a hole plug at this location.

Field Antennas: Field operation often calls for non-resonant, ad-hoc wire antennas. For example, you might use a single wire of 20’ (6 m) or longer, tossed in a tree using a fishing weight or large hex nuts. Another popular field antenna is the short, loaded whip with interchangeable loading coils.

⚠ If you use a short whip, vertical, or a single wire, a ground of some kind is necessary (described at right) to provide good transmit efficiency. Dipoles, inverted Vs, beams, quads, and similar antennas have an inherent *counterpoise*, making ground optional, though still desirable.

SWR: One measure of how close an antenna is to resonance is its *SWR* (standing wave ratio). The KX3 displays SWR in TUNE mode (pg. 14). An SWR of 1.0:1 (**1.0-1** on the KX3’s display) is considered a “perfect” match. To ensure safe operation, the KX3 reduces power if SWR is high.

Using An Antenna Tuner (ATU): An ATU will allow the KX3 to “see” a good match (i.e., a low SWR) even with non-resonant antennas. This allows the transmitter to deliver full power, and can improve receiver sensitivity. An ATU may also allow one antenna to be used on multiple bands. You can use an external ATU (e.g., an Elecraft T1 or KXAT100) or internal (e.g., the KXAT3 option, pg. 25). The KXAT3 stores matching information at multiple points within each band.

Feedline: You can connect a wire antenna directly to the KX3 without any coax or other *feedline*. (A male BNC to binding-post adapter can be used, such as Elecraft #BNC-BP.) However, many antennas will function better when their feed point is well above ground. A multi-band, random-length antenna can be fed with twin-lead, then connected to a *balun* (balanced-to-unbalanced converter, such as the Elecraft BL1 or BL2), which in turn is connected directly to the transceiver.

Grounding and ESD Protection

A ground system using buried rods and/or a ground *counterpoise* (wires radiating out from the antenna) can reduce receive interference and help prevent electrical shock or damage due to electrostatic discharge (ESD). The *ARRL Antenna Book* provides examples. A ground is a definite requirement when you use a whip, vertical, and other antenna that lacks an inherent counterpoise. The ground can be connected to the KX3 at the thumb screw indicated below, on the right side panel. The back thumb screw on the left side can also be used.

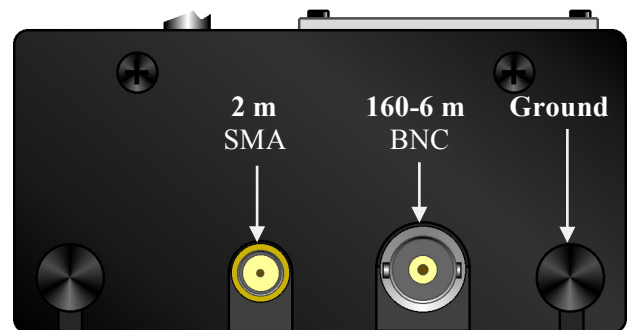

Portable Station Ground: When you’re operating from a temporary location, you can use one or more radials as a ground counterpoise. This can simply be a set of wires tied together at one of the KX3’s ground points, then laid out on the ground in all directions. When possible, use at least one 1/4-wavelength radial for each band used. The length in feet can be calculated from 234 divided by F, where F is the operating frequency in MHz. On 20 m (14-14.35 MHz), the length would be about 16.5 feet.

Pedestrian Mobile Ground: The KX3 can be operated hand-held—even while walking—with a short whip antenna. Such antennas may provide acceptable performance in receive mode without a ground. However, if you plan to transmit, you’ll need a *trailing ground wire* to serve as a minimal counterpoise and greatly improve your transmitted signal. This is true even if the KX3 indicates a low SWR in TUNE mode (without a counterpoise, the SWR reading can be misleading). 13’ is a good choice for a trailing ground wire. This length is about optimum on 20 meters, and is usable on 40-6 meters as well, assuming you’re using a multi-band whip (or an antenna tuner). Small-diameter coax such as RG-174 works well for a trailing wire because it resists getting tangled while you walk.

Control Panel Reference

This section summarizes all KX3 controls. For details, see **Basic Operation** and **Advanced Operating Features**.

To Turn Power ON/OFF: Hold both the **BAND+** and **ATU TUNE** switches for 2 seconds. (See ON/OFF label on left side.)

Tap Functions: Tap a switch or knob briefly to activate the function labeled on or above it, e.g. **RATE**.

Hold Functions: Hold the control for about 1/2 second to activate the function labeled below, e.g. **KHZ**.

Numeric Keypad: Switches and knobs at lower-left form a keypad (0-9/decimal/enter). Used with **FREQ ENT**, etc.

Band Selection

BAND+ / **BAND-** Band up/down, pg. 10

RCL / **STORE** Frequency memories, pg. 17

per-band: tap 1-4; *general purpose (00-99):* use VFO A

FREQ ENT Direct freq. entry (use # keys, then **←**), pg. 10

SCAN Scan from VFO A to VFO B, pg. 17

Display, pg. 8

Operating Mode and VFO Setup

MODE Basic mode; **ALT** Alternate mode (e.g. LSB/USB), pg. 10

DATA Data submode, pg. 18; **TEXT** Text decode setup, pg. 19

A / B VFO A/B swap, pg. 11; **REV** VFO/repeater reverse, pg. 11

A ► B Copy VFO A to B, pg. 11; **SPLIT** Split RX/TX, pg. 19

RIT / **XIT** RX/TX offset, 11; **PF1** / **PF2** Prog. function, pg. 19



Transmit / ATU Control

MSG / **REC** Message play/record, pg. 16

ATU TUNE Start auto antenna tune, pg. 14

ANT Select ANT 1/2 (KXAT100 opt.), pg. 14

XMIT Enter transmit mode (PTT), pg. 14

TUNE Transmit CW carrier at PWR level
(or **MENU:TUN PWR** level, if lower), pg. 14

Transmit Settings

KEYER/MIC WPM, pg. 14; mic gain, pg. 14

PWR Set power level, pg. 14, 15

CMP Speech compression, pg. 15 *

PITCH CW sidetone, pg. 16; FM tone, pg. 15 *

DLY CW QSK delay, pg. 16; VOX delay, pg. 16 *

VOX VOX/PTT (CW/voice separate), pg. 16, 15

Offset / VFO B and Misc.

OFS/VFO B RIT/XIT/VFO B, pg. 11

CLR Clear RIT/XIT offset, pg. 11

RATE Select 1/10 Hz VFO steps, pg. 11

KHZ Select coarse VFO steps, pg. 11

DISP Show voltage etc. on VFO B, 11 *

MENU Use VFO B to select, A to edit

Receive Settings

AF / RF-SQL Receiver gain control, pg. 12

MON Monitor & switch tones volume, pg. 12

PRE Preamp, pg. 13; **ATTN** Attenuator, pg. 13

NR Noise reduction, pg. 13 *

NB Noise blanking, pg. 13 *

PBT I/II Passband tuning (I=WIDTH/LO, II=SHIFT/HI), pg. 12

NORM Filter passband normalization (per-mode), pg. 12

APF Audio peaking filter, pg. 13; **SPOT** CW spot tone, pg. 13

NTCH Autonotch (SSB) or manual notch (CW), pg. 13 *

CWT CW/DATA tuning aid (uses upper portion of S-meter), pg. 13

VFO A, pg. 11

Transmit LED, pg. 14

Delta-F LED, pg. 11

* To adjust the parameter for this switch function, use the knob immediately above the switch.

Display (LCD)

Bar graph, receive mode: Shows RX signal strength in S-units (S-meter). If **CWT** is turned on, the right half of the S-meter becomes a tuning aid (pg. 13). Reducing RF gain adds a moving reference segment (pg. 12).

Bar graph, transmit mode: Shows antenna **SWR** and **RF** output (pg. 14). In voice modes, shows **CMP** (compression) and **ALC** (mic level) when mic gain or CMP are set (pg. 15). ALC scale also used to set **DATA** audio level (pg. 18).

VFO Icons: Shows that a VFO or menu entry is locked. The **TX** icon points to the transmit VFO:

TX ↑ *VFO A is the transmit VFO*

TX ↓ *VFO B is the transmit VFO; see **SPLT***

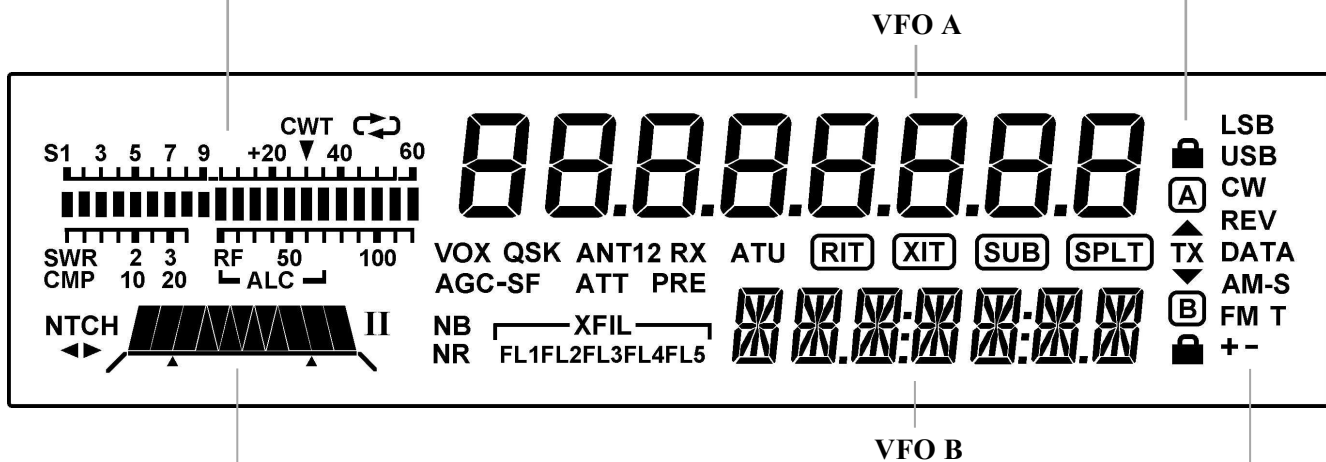

Filter Passband Graphic: Shows location of receive filter passband (pg. 12)

Filter Icons:

NTCH Auto or manual notch (**NTCH**, pg. 13)

◀▶ Manual notch (**NTCH**, pg. 13)

I / II PBT filter function (**I/II**, pg. 12)

XFIL Filter (**FL1-FL3** used, pg. 12)

Mode Icons

Basic modes (**LSB** or **USB**, **CW**, **DATA**, **AM**, or **FM**) are selected by tapping **MODE**. Alternate modes (**CW REV**, **DATA REV**, **AM-S**, **FM +/-**) are selected by holding **ALT**. **LSB** and **USB** are alternates of each other. In SSB mode, the **+** icon indicates ESSB (pg. 22). **T** indicates FM PL tone (pg. 15) or CW/DATA text decode (pg. 19).

Other Icons:

CWT CW/data tuning aid on (**CWT**, pg. 13)

↻ Message play/rec (**MSG** / **REC**, pp. 16, 21)

VOX VOX enabled (**VOX**, pp. 15, 16)

QSK Full break-in CW enabled (**DLY**, pg. 16)

NB Noise blanker on (**NB**, pg. 13)

NR Noise reduction on (**NR**, pg. 13)

ANT Antenna 1/2, KXAT100 (**ANT**, pg. 25)

RX Automatic RX attenuation in effect (pg. 13)

ATT Attenuator on (**ATT**, pg. 13)

PRE Preamp on (**PRE**, pg. 13)

ATU ATU enabled (**ATU TUNE**, pg. 14)

RIT RIT on (**RIT**, pg. 11)

XIT XIT on (**XIT**, pg. 11)

SUB Dual-watch enabled (**DUAL RX**, pg. 20)

SPLT Split mode in effect (**SPLT**, pg. 19)

Basic Operation

This section describes basic KX3 controls and features. Once you've mastered the basics, you'll be ready to explore the **Advanced Operating Features** section (pg. 17), which covers built-in text decode, frequency memories, dual watch and other topics.

Getting Started

Before using the KX3, you'll need to connect a power supply and an antenna, at minimum. See **Installation** (pg. 4) for more details.

Turning the KX3 On/Off

To turn the KX3 on or off, press and hold the **BAND-** and **ATU TUNE** switches simultaneously for about two seconds, then release. Left side labeling identifies these two switches (see below). This power on/off method reduces the likelihood of accidental activation in a backpack or carrying case.

⚠ Always turn the KX3 off as described above before turning off or disconnecting any external power source. This will ensure that your current VFO settings, etc., are saved.



Switch **TAP** and **HOLD** Functions

All KX3 switches have two functions:

- **Tap** to activate the function labeled **on** a switch, e.g. **RATE**
- **Hold** for about 1/2 second to activate the function labeled **below** a switch, e.g. **KHZ**

AF Gain and other Knob Functions

Each of the four small knobs has a primary function that is in effect when you turn on the KX3. For example, the knob at far left, **AF / RF-SQL**, normally controls receiver **AF gain** (volume). As you rotate this knob, the AF gain setting is displayed in the VFO B area.

Tapping this knob briefly switches to its secondary function, **RF gain** (squelch in FM mode). **Holding** the knob—pushing it for over 1/2 second—switches to a third function, **MON** (volume setting for transmit monitor and switch tones).

The small knobs are also used in conjunction with nearby switches. For example, if you tap **DISP**, rotating the knob directly above it (**OFS / VFO B**) will scroll through several special displays, including time, supply voltage, current drain, etc.

Using the Menu

The menu is used to tailor the transceiver to your operating preferences.

To access the menu, hold **MENU** until the **BKLIGHT** (LCD brightness) menu entry appears in the VFO B area. The *parameter*, in this case the brightness level, appears in the VFO A area.

To change the value of a menu parameter, rotate VFO A (large knob). In the case of **BKLIGHT**, rotating the knob will select backlight **ON** or **OFF**.

To scroll through menu entries, use the small knob above the menu switch, **OFS/VFO B**.

To exit the menu, hold **MENU** again.

i While in the menu, holding **MENU** for about 3 seconds displays usage information about the present menu entry. Tap any switch to cancel.

Configuration Menu Functions

Now that you know how to use the menu, you may wish to review the **Configuration** section (pg. 29) to make sure the KX3 is configured properly for your installed options and operating preferences.

There are also a number of calibration steps performed on your KX3 at the factory (for both kits and assembled radios). See **Calibration**, pg. 31.

Band Selection

The KX3 covers the 160-6 m amateur bands. Characteristics of each band are summarized below. For further information, see the ARRL *band plan*:

<http://www.arrl.org/band-plan-1>

You can change bands using **BAND+** or **BAND-**, memories (pg. 17), or **FREQ ENT** (see below).

i You can remove bands you don't use from the **BAND +/-** switch group using **MENU:BND MAP**.

Band (m)	Range (MHz)	Best DX	Other Characteristics
160	1.8-2.0	Night	Challenging "Top Band"; high power often used to counter noise
80	3.5-4.0	Night	Excellent regional band; many CW and SSB nets; AM ~3.870
60	~5.3-5.4	Night	Shared with government services; power level and modes restricted
40	7.0-7.3	Night	Excellent local CW/SSB band by day; QRP & data modes, 7.03-7.04
30	10.0-10.15	Both	DX possible anytime; no contests
20	14.0-14.35	Both	Very popular DX & contest band; many nets on SSB; Data modes: PSK31 ~14.070; RTTY ~14.085
17	18.068-18.168	Day	Long-haul DX band; no contests; "HF Pack" at 18.1575 (often QRP)
15	21.0-21.45	Day	DX/contest band; low power very effective when band is open
12	24.89-24.99	Day	Excellent DX band; no contests
10	28.0-29.7	Day	Great DX band when open; CW beacons 28.2-28.3; FM 29.6-29.7
6	50-54 (VHF)	Both	Active night or day during rare DX openings; some FM repeaters

Direct Frequency Entry

The controls below function as a numeric keypad (see **0 - 9** labels) when used with **FREQ ENT**.



First, tap **FREQ ENT**. Then enter up to three MHz digits, optionally followed by a decimal point (**ATU TUNE** switch) and up to three kHz digits. Next tap **←** (**MSG** switch) to accept, or any other switch to cancel. **Examples:**

14.255 MHz: **FREQ ENT** 1 4 . 2 5 5 **←**

7.000 MHz: **FREQ ENT** 7 **←**

Mode Selection

Each mode is described briefly below. Later sections cover each mode in detail.

Tap **MODE** one or more times to select SSB, CW, AM, or FM mode. **ALT** selects alternate modes, such as **CW reverse**. Tap **DATA** to select data mode. To select a data sub-mode, tap **DATA** again, then rotate **↻** **OFS/VFO B**.

SSB (single sideband, pg. 15) is a narrow-banded voice mode that conserves space in crowded band segments. It's the most popular mode overall. LSB (lower sideband) is usually used on 160, 80, and 40 meters, while other bands use USB (upper sideband). You can override the default using **ALT**.

CW mode (pg. 16) uses on-off keying of the carrier. CW requires very little bandwidth, providing a high signal-to-noise ratio that's ideal for low-power (QRP) use. It's also a popular mode for DXing and contests. Holding **ALT** switches to **CW REV** (CW reverse), reversing the received sideband in CW mode from LSB to USB. This may reduce the level of interference (QRM).

AM mode (amplitude modulation, pg. 15) is characterized by its good fidelity. It is much less power-efficient than SSB. AM amateur operation is often found on 160, 80, 40, and 10 meters.

FM mode (frequency modulation, pg. 15) is most often used for local communications, and can be found on 10 m and up (see ARRL band plan). The KX3 supports simplex and repeater operation, including tone encoding. Many repeaters can be found on the 2-meter band (144-148 MHz), which is covered by the KX3-2M option module (pg. 25).

i If you don't plan to operate in AM or FM modes, you can turn them off individually using the **AM MODE** and **FM MODE** menu entries (pg. 35).

DATA modes (**Advanced Operating Features**, pg. 18) typically use a computer connected to the transceiver to send/receive text. Although SSB modes can also be used for this purpose, the KX3's audio-based data modes (**DATA A** and **AFSK A**) optimize settings for data rather than voice.

The KX3 also has two built-in data modes that don't require a computer: **FSK D** (narrow-shift RTTY) and **PSK D** (PSK31). These modes use the KX3's display for receive, and a keyer paddle for transmit, converting the CW you send into data.

VFOs A and B

The KX3 provides two *VFOs* (see glossary, pg. 50). Use of VFO B is optional. The VFO knobs are located in the area shown below. Each VFO has independent frequency, mode, and filter settings.



VFO A normally controls both the receive and transmit frequency. Most contacts occur between stations tuned to about the same frequency, so if you use VFO A to tune in a signal clearly, there's a good chance they'll hear you when you transmit.

VFO B can serve as a holding register for a second frequency of interest, then swapped with VFO A as needed (see **A / B** at right). To tune VFO B directly, first make sure the **B** LED above the knob is lit. If not, tap the **OFS/VFO B** knob. Also see **SPLIT** (pg. 19) and **Dual Watch** (pg. 20).

Tuning rates: Tapping **RATE** selects either 1 Hz or 10 Hz VFO tuning rate. Holding **KHZ** selects a per-mode coarse tuning rate (see **MENU:VFO CRS**, pg. 30). SSB stations often align on 0.5 or 1.0 kHz boundaries. AM broadcast stations are typically spaced at 5, 9, or 10 kHz.

To lock VFO A: Hold **KHZ** for about 3 seconds. Tap **RATE** to unlock. To lock VFO B, swap it with VFO A first, lock it, then swap back.

i You can use the **OFS/VFO B** control to tune VFO A in coarse steps, while the VFO A control itself is still set up for fine steps. First, make sure the **OFS** LED is lit (tap the **OFS/VFO B** knob one or two times). RIT and XIT (described at right) must also be turned off. To disable the VFO offset-tuning feature, see **MENU:VFO OFS**.

To copy VFO A's frequency to VFO B: Tap **A ▶ B**. Tapping a second time copies VFO A's mode and filter settings to VFO B as well.

VFO A and B swap: Tap **A / B** to exchange VFO frequencies, modes, and all other settings.

VFO A/B temporary reverse: Sometimes you'll want to swap the VFOs temporarily to look for an open transmit frequency when operating split (pg. 19). In this case, hold **REV**. The VFOs will be swapped back as soon as you release the switch. **In FM mode, REV** swaps receive/transmit frequencies and the repeater offset direction (pg.15).

Incremental Tuning (RIT and XIT)

RIT, or *receive incremental tuning*, provides a means of adjusting the receive frequency without affecting your transmit frequency. This control is sometimes called a *clarifier* since it can be used to tune in SSB voice signals. But RIT can also be used in CW and DATA modes, in the event that a station calls you slightly off-frequency. RIT and XIT use the tuning rate (1/10 Hz) selected for the VFOs.

XIT, or *transmit incremental tuning*, adjusts the transmit frequency without affecting the receive frequency. See **Split and XIT**, pg. 19.

Δ F (Delta-F) LED : Whenever an RIT or XIT offset is in effect, or during split operation, the Δ F LED turns on as a reminder that your receive and transmit frequencies are different.

To use RIT or XIT: First, tap **RIT** or **XIT**. This turns on the **RIT** or **XIT** icon on the display, as well as the **OFS** LED (above **OFS/VFO B**). Then adjust the offset using **OFS/VFO B**.

To zero the RIT/XIT offset: Hold **CLR**.

i You can still use the **OFS/VFO B** control to tune VFO B, even if RIT or XIT is turned on. Just tap the knob to switch its function back to VFO B (the **B** LED will turn on). The RIT/XIT icons on the LCD will retain their current states.

Special VFO B Displays

The VFO B display area can show several useful parameters. To see these, tap **DISP**, then rotate the **OFS/VFO B** control. This will cycle through several displays including time, supply voltage, current drain, power amplifier temperature, synthesizer temperature, audio voltmeter, and relative audio (dBV) meter. For details see pg. 22.

Receive Settings

The **RX** control group, shown below, is used to set up the KX3's receiver. Directly above these controls is the *filter passband graphic*, which shows the shape and position of the receiver's passband. This determines what pitch range you'll hear.



AF Gain, RF Gain, and Squelch

The \odot **AF / RF-SQL** knob normally controls receiver **AF gain**. Tapping the knob switches its function to **squelch** (FM mode only) or **RF gain** (all other modes). Also see “**AF, RF, and IF**” in the glossary (pg. 50).

RF gain is normally left at maximum (**-0 dB**). Reducing RF gain may be useful in some strong-signal conditions. If you reduce RF gain more than a few dB, a separate segment of the S-meter turns on as a reminder. The segment used varies with the amount of RF gain reduction. (A high S-meter reading may hide the RF gain indicator segment.)

Squelch is used to mute the receiver until a signal appears. It is most often used with repeaters. The control adjusts the signal threshold required for squelch to “open,” unmuting the receiver.

Voice Monitor/CW Sidetone Level (MON)

Holding \odot **AF / RF-SQL** temporarily switches its function to \odot **MON**, which controls how much of your own signal you hear when transmitting. Transmit monitor setup is covered on pg. 14.

i Switch activation tones, if used, have the same volume level as the CW sidetone (as set in CW mode using \odot **MON**). Switch tones can be set to off, on, or Morse code characters at various speeds using the **SW TONE** menu entry.

Passband Tuning Functions (PBT I/II)

The \odot **PBT I/II** control is used to shape the KX3's receive filter passband. In general, a narrow passband reduces interference (QRM) and noise (QRN), while a wider passband improves fidelity.

In voice modes, tapping \odot **PBT I/II** normally selects *low-cut* (function **I**) or *high-cut* (function **II**). These functions remove low- or high-pitched interfering signals. Examples of filter graphic segments that might turn off as the result of a low-cut or high-cut are shown in light gray below. (To select *width/shift* for SSB, instead, use **PBT SSB**.)



In CW and DATA modes, the passband functions are *width* (**I**) and *shift* (**II**). The effect of these functions is illustrated below. Reducing the width or shifting the passband may attenuate an interfering signal above or below the desired one.



Holding \odot **PBT I/II** *normalizes* the passband (**NORM**), centering it and setting it to the default width for the current mode. Two small "anchors" appear at the left and right ends of the graphic. Holding **NORM** again restores the previous passband settings.



Roofing Filters (XFIL)

The **XFIL** icons, to the right of the filter passband graphic, show whether the optional *roofing filters* (**FL2**, **FL3**) are in use. These filters, located on the KXFL3 option module, can reject strong nearby signals that might interfere with weaker ones.

When **FL1** is indicated, the roofing filters are bypassed, and the pre-DSP bandwidth is about 15 kHz. **FL2** (3000 Hz) and **FL3** (1000 Hz) are automatically selected, when possible, based on the operating mode and settings of the filter controls.

Dual watch (**MENU:DUAL RX**) also uses **FL1**, overriding the normal per-mode filter selection.

Preamp and Attenuator

PRE turns on the RF preamp. It should be used only when signals are very weak. Preamp gain can be set on a per-band basis using **MENU:PREAMP**. **ATTN** turns on the 15-dB RF attenuator, which can protect the receiver from strong interfering signals.

i The KX3 will automatically reduce receive gain in the presence of very strong signals. The receive overload icon (**RX**) will alert you to this (pg. 8).

Noise Reduction

Noise reduction (NR) removes random background noise (hiss or static). It has a characteristic “hollow” sound. Higher settings may attenuate weak signals.

Holding **NR** turns on noise reduction and displays its setting, which can be adjusted using the knob above the switch. Tap any switch to exit the setting display. Hold **NR** again to turn noise reduction off.

Noise Blanking

Noise blanking can eliminate repetitive noise such as that from power lines, appliances, and vehicle ignitions systems. Use the lowest effective setting to avoid unwanted signal/noise interaction.

NB turns on the noise blanker. The NB setting is adjusted in the same way as NR (see above).

Audio Peaking Filter (APF)

APF turns on a very narrow filter that improves copy of very weak CW signals buried in noise. The filter graphic changes to that shown below. With APF on, PBT function **I** still adjusts the overall passband width; function **II** tunes the APF center pitch. 1-Hz VFO tuning is automatically selected.



Notch Filtering

In CW and data modes, holding **NTCH** turns on a manually adjusted *notch filter* and displays the notch pitch. Adjust the pitch, using the knob above the switch, until an interfering carrier is reduced in volume. Tap any switch to exit the notch pitch display. Hold **NTCH** again to turn it off.

In SSB and AM modes, **NTCH** turns on *auto-notch*, which locates and suppresses one or more carriers automatically.

CW/DATA Tuning Aid (CWT)

Accurate tuning of received signals is required before you call a station, or when you're using built-in text decode (**TEXT**, pg. 16). Tuning can be done by ear. But CWT, in conjunction with **Auto-SPOT** (below), can often tune in stations for you. When you hold **CWT**, the upper half of the S-meter becomes a receive VFO tuning aid for CW and some data modes.

A CW signal will appear as a single bar in the CWT display, as shown in the left example below. Use VFO A to tune in the signal until the bar directly under the CWT pointer is turned on. A narrow filter width is recommended (100-400 Hz). This display also applies to PSK31 (PSK D, pg. 18).

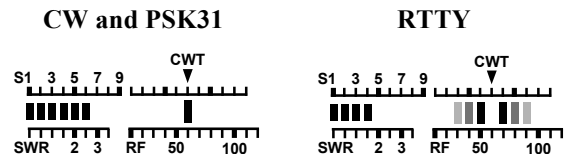

In RTTY or *radioteletype* modes (FSK D, AFSK A; pg. 18) mark and space tones are represented by three bars on either side of the CWT pointer. If no RTTY signal is present, you'll see the “ghosting” effect shown above. As you tune in an RTTY signal, the number of solid bars will increase. Keep tuning until you see a rough balance between left and right solid bars during an RTTY transmission.

SPOT and Auto-SPOT

You can use **SPOT** to manually tune in a CW or PSK31 signal, matching it to your sidetone pitch. First turn off **CWT** if it is on. Then, tap **SPOT** and adjust VFO A until the signal pitch matches the sidetone. Use **MON** to adjust the sidetone volume level.

To use auto-SPOT: First turn on **CWT**. Tapping **SPOT** will then automatically tune in a received signal that falls within the CWT display range.

i If RIT is turned on, auto-SPOT will change the RIT offset, not the VFO A frequency.

i Auto-SPOT may not be usable if more than one signal is in the CWT range, or if the signal is very weak or noisy. Try using a narrower bandwidth in this case.

Transmit Settings

The **TX** control group is used to set up the KX3's transmitter. The TX LED turns on during transmit.

⚠ Caution: This is only an overview of TX settings. Follow the detailed transmit setup instructions in later sections for each mode.



Keyer Speed/Mic Gain and Power Output

In CW mode, **KEYER/MIC** sets the keyer speed (in WPM). In voice modes, it sets mic gain.

A hold of this knob selects **PWR** (power out). Power in watts is shown on the **RF** bar graph. Power output is typically 10 W+ on 160-15 m, and 8 W+ on 12-6 m. The 6-m setting is independent.

⚠ Maximum available power output varies. If power is lower than expected, use the special VFO B displays (pg. 11) to check supply voltage, current drain, and PA temperature. The selected parameter will be shown on VFO B during **TUNE** (SWR is shown on VFO A). A reduced-current TX mode is automatically used when possible. This is indicated by a decimal point after the “W” (e.g. **3.0 W.**).

Other Transmit Settings

Hold **MON** to set the transmit monitor volume (speech in voice modes, sidetone in CW mode).

CMP sets the amount of *speech compression*, which increases average power output, making your voice sound louder. Adjust compression using the knob above the switch; to finish, tap **CMP** again.

PITCH is used to set the sidetone pitch in CW mode, and the tone-encode pitch in FM mode (pg. 15). It displays the mark or center pitch and data shift in some data modes.

DLY sets the VOX (voice-operated transmit) delay time in voice modes (pg. 15). In CW mode, **DLY** sets the break-in or *QSK* delay (pg. 16).

VOX selects the keying mode: PTT (push-to-talk) or VOX (voice- or keying-operated transmit). With PTT selected, the transmitter is enabled by tapping **XMIT** or by holding the mic's PTT button. With VOX selected, the **VOX** icon turns on, and transmit starts by speaking (voice modes) or when keyed (CW mode). Also see **DLY** (at left) and *MENU:VOX GN* (p. 35).

Transmit and ATU Control

The switches in the group shown below perform various transmit control functions.



MSG and **REC** play/record messages (pg. 16, 21).

ATU TUNE starts automatic antenna matching if a KXAT3 internal ATU is installed (pg. 25). The *ATU MD* menu entry must be set to **AUTO** mode. Matching takes an average of 4 seconds, initially. Settings are then recalled instantly on band change, as well as when you transmit after moving the VFO a significant distance. The ATU icon will flash briefly whenever new L-C network settings are recalled. In CW mode, recall of settings is delayed until a brief pause in keying (about 0.5 seconds).

i With difficult loads, tap **ATU TUNE** a second time within 5 seconds to search for a lower SWR.

ANT controls **ANT1/2** selection on the KXAT100 external ATU. **ANT** does not switch between antenna jacks on the KX3 itself. The BNC jack is always used on the 160-6 m bands, and the SMA jack is used only with the KX3's 2-meter module.

XMIT is equivalent to PTT (push-to-talk). Tapping this switch places the KX3 into transmit mode.

TUNE is used to put out a CW signal at the power level selected by the **PWR** control. This is useful with external wattmeters and antenna tuners. If the *TUN PWR* menu entry is set to a numeric value, rather than **NOR**, then this value—if lower—overrides the power control setting.

Voice Modes (SSB, AM, FM)

Basic Voice-Mode Setup

i To avoid transmitting a signal during voice-mode setup, you can set \odot **PWR** to 0.0 watts.

- **Choose a mode:** Tap **MODE** to select **LSB/USB**, **AM**, or **FM** mode. In SSB modes, **ALT** alternates between **LSB** and **USB**.
- Hold \odot **MON** to set the voice monitor level. **High MON settings may result in audio clipping or distortion.** Start with 3 to 5.
- Tap **CMP** and set it to **0** using the knob above. Tap it again to exit the CMP display.
- **Enable transmit:** Tap **XMIT** or hold in the mic's PTT switch. **Note:** Hand mics like the Elecraft MH3 should nearly touch your mouth when you are speaking (about 1/8" [3 mm]).
- **Adjust mic gain level:** While speaking into the mic, adjust \odot **KEYER/MIC** (mic gain). This will turn on the transmit **CMP** and **ALC** bar graphs. While speaking, adjust mic gain for about 5 ALC bars (see below). **Mic gain for the Elecraft MH3 is typically 15-25.**



- **Speech compression (optional):** To use speech compression, tap **CMP** and adjust the level using the knob above the switch. While you're speaking, the **CMP** scale (see above), shows compression level. **High CMP settings may result in distortion.** Start with 1 to 10.
- **Set the power level:** Exit transmit mode and adjust \odot **PWR** to the desired output level. **Do not use MIC gain to set power level.** Set mic gain to a fixed level as described above.

Voice Mode VOX Setup

VOX selects push-to-talk (PTT) or voice-operated (VOX) transmit (**VOX** icon on). VOX hold time is set with **DLY** (pg. 14).

MENU:VOX GN (VOX gain) should be set to trigger at normal speech level, but not in response to incidental noise. Start with low settings (10-20). **MENU:VOX INH** (VOX inhibit, or *anti-vox*) can prevent speaker audio from triggering VOX.

Transmit Metering in Voice Modes

Normally, the SWR/RF bar graph is active during transmit in all modes. In voice modes, you can switch to the **CMP** / **ALC** bar graphs by tapping \odot **KEYER/MIC**. This also occurs automatically if you adjust mic gain or speech compression level.

FM Operation

i If you don't use FM mode, you can disable it by setting **MENU:FM MODE** to **OFF**.

To setup for repeater use:

- Hold **ALT** one or more times to select simplex, TX up (+ icon), or TX down (- icon). If an offset is in effect, **REV** swaps RX/TX frequencies and offset direction.
- Set up the required repeater offset using **MENU:RPT OFS**.
- Select a coarse VFO step size for FM mode using **MENU:VFO CRS**.
- If PL tone encode is required, hold **PITCH** to turn it on, and rotate the knob above this switch to select the tone frequency. Hold **PITCH** again to turn PL tone encode off. When tone encode is on, a **T** appears in the mode icon area.
- To change the FM deviation level for voice and PL tones, see **MENU:FM DEV**.
- **Squelch:** Tap \odot **AF / RF-SQL**, then rotate the knob to select the desired squelch threshold. (In all other modes, the alternate knob function is RF gain.) Tap the knob again to return to the AF gain function.

AM Operation

AM receive on the KX3 uses traditional envelope detection. You can also listen to AM signals using LSB or USB modes, which may provide better copy during fading conditions.

During AM transmit, it is normal for the RF bar graph to indicate about one-third to one-half the power level set by the power control. Transmit efficiency is much lower in AM mode than SSB as discussed on pg. 10.

i To disable AM mode, set **MENU:AM MODE** to **OFF**.

CW Mode

Basic CW-Mode Setup

- **Mode selection:** Tap **MODE** to select **CW** (CW normal). In some cases an interfering received signal can be eliminated by switching to **CW REV** (CW reverse) using **ALT**. This doesn't affect transmit.
- **Transmitter keying method:** The **VOX** switch selects either VOX or PTT keying for CW mode. Most operators use VOX, allowing the transmitter to be keyed immediately whenever a hand key or keyer paddle is used. To manually enable transmit via the **XMIT** switch, select PTT.
- **Set sidetone pitch** using **PITCH**. The ideal pitch for most operators falls in the range of 400-600 Hz. The receiver's passband will be centered at the pitch you select.
- Set sidetone volume using **MON**.
- **Adjust the break-in delay:** Tap **DLY** to set the break-in or *QSK* delay (the time before the receiver recovers after key-up). A setting of 0 provides "full break-in" or "full QSK." (The QSK icon will appear.) This allows the receiver to recover quickly so you can hear another station transmitting between your characters.

CW Receive Filtering

As conditions change, you may need to adjust the filter passband as described on pg. 12. Also, you'll find the audio peaking filter (**APF**) to be very useful with weak CW signals.

Off-Air Code Practice

Sending CW normally produces both a sidetone and a transmitted signal. If PTT-CW is selected (by holding **VOX**), hitting the key will generate only a sidetone (unless you tap **XMIT**). This is useful for code practice or keyer speed adjustment.

CW-Mode Menu Settings

Use the menu to set up iambic keying (*CW IAMB*), keying weight (*CW WGHT*), and paddle normal/reverse or hand key (*CW KEY1* for the **KEY** jack, and *CW KEY2* for the KXPD3). Also use *CW WGHT* for CW transmit in SSB mode.

CWT, SPOT and Auto-Spot

When calling a station, you should try to match your frequency to theirs. To facilitate this, the KX3 provides both manual and automatic spotting for CW, FSK-D, and PSK-D signals. See pg. 13.

CW Text Decode/Display

The KX3 can decode transmitted and received CW signals, displaying the text on VFO B (pg. 19). This is especially useful when you're learning CW, or if someone who doesn't know CW is looking over your shoulder while you make CW QSOs. It's also indispensable for CW-to-DATA operation (pg.18).

CW/DATA Message Record/Play

There are 6 text message buffers, each holding up to 250 characters. These apply to CW and to DATA modes FSK D and PSK D.

! Messages can be recorded using the KX3's built-in keyer function (using either your keyer paddle or the KXPD3). An external keyer cannot be used. Messages can also be created or edited using the *KX3 Utility* computer application.

Message Record: To start recording, hold **REC**, then select a message buffer by tapping any of switches **1** through **6** on the numeric keypad. The remaining buffer space will be displayed as you send. Tap **MSG** to terminate record.

Message Play: To play, tap **MSG**, then select a message buffer (**1** through **6**). To cancel, tap **XMIT** or hit the keyer paddle or hand key.

Message Erase: Hold **REC**, then select a message buffer (**1** through **6**), then hold **CLR**.

Auto-Repeat: To auto-repeat a message, tap **MSG**, but then *hold* rather than *tap* a message switch (**1** through **6**). *MENU:MSG RPT* sets the message repeat interval (1 to 255 seconds).

Chaining: *Tapping* a message switch during playback chains another message onto the message being played. *Holding* a message switch during playback chains a repeating message.

Advanced Operating Features

Frequency Memories

The KX3 has 100 general-purpose frequency memories (**00-99**), plus four *quick memories* on each band, accessed by tapping **1** - **4** on the numeric keypad. Each memory stores VFO A and B frequencies, modes, and other settings.

Quick memories provide an easy way to get to segments used for each operating mode. For example, you could use quick-memory **1** as an SSB starting point, use **2** for CW, **3** for data, etc., on each band.

To store a general-purpose memory (00-99): First hold **STORE**, then locate the desired memory by rotating the VFO A knob. The VFO A frequencies presently stored in each memory will be shown as you scroll through them. When you reach the desired memory number, hold **STORE** again to finish, or tap any other switch to cancel.

To recall a general-purpose memory: Hold **RCL** (recall), then select memory **00-99** using VFO A. Tap any switch to exit.

To store a per-band quick memory: Hold **STORE**, then tap the target quick memory (**1** - **4**).

To recall a per-band quick memory: Hold **RCL**, then tap the target quick memory (**1** - **4**).

To erase a general-purpose memory: While scrolling through memories to save or recall, hold **CLR**. (Not applicable to quick memories.)

To add a text label to a general-purpose memory: First hold **RCL**, then select a memory (**00-99**) using VFO A. Next, rotate VFO B to select each text label position in turn as indicated by the flashing cursor. Use VFO A to change label characters (A-Z, 0-9, and various symbols). After editing, hold **STORE** to finish the operation.

i Adding an asterisk (*) at the start of a label designates a memory that is part of a channel-hopping group (described at right).

i The *K3 Memory* program (pg. 28) can be used to simplify setup and labeling of memories.

Scanning

Scanning allows the KX3 to tune any portion of a band continuously. Normal scanning mutes the receiver until a modulated signal is found. “Live” scanning keeps the receiver unmuted, and is stopped by the operator. This is useful on very quiet bands.

To use scanning:

- Set VFO A and VFO B to the desired start/end frequencies. Also select an operating mode.
- Select a tuning rate for the scan using **RATE** (10 Hz or 100 Hz), or **KHZ** (for fast scanning).
- Store this setup in any frequency memory.
- To start scanning:
- Recall a scanning memory using **RCL**.
- Hold **SCAN** to start scanning. To scan with the receiver live (unmuted), continue to hold **SCAN** until you see **AF ON** (about 2 seconds).

To stop scanning: Rotate VFO A or tap any switch. To restart, hold **SCAN**.

Channel Hopping

Scanning (or manually tuning) among a group of memories is referred to as **channel hopping**. This is most useful on channelized bands (60, 6, and 2 meters). The memories in the group must all be in the same band, but can have different modes.

To set up channel hopping:

- Set up VFO A for the first target frequency and mode. Store this setup in a general-purpose memory (**00-99**) as described at left.
- Set up and store the remaining frequencies *in the next successive numbered memories*.
- Add a text label to each memory in the group, using an asterisk (*) as the first character.

To start manual channel hopping, **RCL** any one of the memories in the target group. VFO A will now hop among the grouped memories as you turn it.

You can then start scan (or live scan) among the grouped memories using **SCAN**. To disable channel hopping, tap **RATE** or change bands.

Data Modes

The KX3 supports data operation via a computer and special software. But it can also be used in **RTTY** and **PSK31** modes *without* a computer via the KX3's built-in FSK D and PSK D modes.

⚠ 5.0 watts or lower is recommended in all data modes. The KX3 will reduce power, if necessary, to maintain a safe operating temperature.

FSK D Mode (RTTY)

⚠ MIC gain, RX/TX EQ, and CMP are not applicable to FSK D and PSK D modes.

FSK D (RTTY¹) is the easiest data mode to use:

- Tap **DATA** to select data mode.
- Tap **DATA** again and rotate \odot **OFS/VFO B** to select the **FSK D** sub-mode. Tap the switch again to exit the sub-mode display. A dual-passband (mark/space) filter will appear:



- Hold **TEXT** to turn on text decode.
- Hold **CWT** to turn on the tuning aid (pg. 13).

You'll now be able to copy RTTY signals. RTTY can often be found on 20 meters from 14080-14090 kHz. (If you see only numbers and punctuation, try tapping **DATA** twice to restore "letters" mode.)

To transmit in FSK D mode (CW-to-Data): Plug a keyer paddle into the KEY jack, or attach a KXPD3 paddle. (See the **CW KEY1** and **CW KEY2** menu entries.) When you send CW, the KX3 will convert it to RTTY. (You'll hear the CW sidetone as well as weak RTTY tones.) You can use CW message memories in FSK D mode, as well as *KX3 Utility's Terminal* function (pg. 28).

i The KX3 adds a 4-second "idle time" (giving you time to decide what to say next) after you stop sending. At the end of this period, the receiver is re-enabled. To terminate the idle period quickly, send the character **· · - -** in CW. This "IM" *prosign* can also be inserted at the end of message buffers.

¹ FSK stands for *frequency-shift keying*, the modulation method used with RTTY (radioteletype). The KX3 uses the most common shift, 170 Hz. RTTY signals are encoded using a 5-level code called *baudot*, at a baud rate of 45 baud, or about 60 words per minute.

PSK D Mode (PSK31)

PSK D is the KX3's built-in implementation of PSK31², a narrow-band data mode which is reliable even at very low power levels. 5 watts or less is strongly recommended to keep distortion low.

To use PSK D, set up the KX3 as described at left for FSK D, but select the **PSK D** sub-mode. Before attempting to transmit in this mode, you should practice tuning in signals. Try 14070-14073 kHz. CWT can be used in this mode (see pg. 13).

DATA A and AFSK A (Audio Data Modes)

Many audio-generated data transmissions can be heard on the bands, using PSK31, RTTY, Pactor, Olivia, MFSK, JT65 and other modes. A computer, sound card, and appropriate software are normally used. **DATA A** mode is provided for this purpose. Unlike SSB modes, DATA A disables compression and RX/TX EQ. Upper sideband is the default.

For audio-based RTTY, you can also use **AFSK A**. Like FSK D, AFSK A provides a dual-passband RTTY filter and text decode. The VFO is tuned to the mark frequency. Lower sideband is the default.

To use these audio data modes:

- Tap **DATA** twice; rotate \odot **OFS/VFO B** to select the **DATA A** or **AFSK A**. Tap the switch again to exit the sub-mode display.
- In **AFSK A** mode, optionally hold **TEXT** to turn on text decode, and **CWT** to turn on the CW/data tuning aid.
- Connect your computer's audio output to the MIC jack. (You can either wire the plug to activate the PTT line on transmit, or use VOX.) Connect the KX3's PHONES jack to your computer's audio input. High-quality shielded cables should be used. You may need an attenuator if the drive levels are too high.
- Refer to your data communications software manual to determine how to set up the KX3's VFO for accurate frequency display.
- While transmitting audio data, adjust MIC gain for no more than 4 to 5 bars of ALC indication.
- **RX/TX EQ and CMP are not applicable.**

² PSK stands for *phase-shift keying*. 31 refers to the baud rate, 31.25 baud. PSK31 signals are encoded using a very efficient representation called *varicode*.

Text Decode And Display

The KX3 can decode CW, PSK31 (PSK D) and RTTY (FSK D). CW speeds from about 8 to 70 WPM can be decoded. Decoded text is displayed on VFO B. If no signal is tuned in, random characters may be displayed.

To set up text decode:

- Select the desired mode (CW, FSK D, or PSK D) using **MODE** or **DATA**.
- If a special VFO B display mode is in effect, cancel it by tapping **DISP**.
- You'll probably want to turn on **CWT** as a tuning aid (pg. 13). This also enables auto-spot, which can automatically tune-in signals.
- Hold **TEXT**. In DATA modes, this will alternate between **DEC ON** and **DEC OFF**. (The **T** mode icon appears when it is on). In CW mode, use \odot **OFS/VFO B** to select a text decode mode. **TX ONLY** displays only CW characters you send using the internal keyer. To decode text from on-air CW signals, use one of the **RX THRn** settings. Turn **CWT** on and adjust the threshold so that the CWT bar graph segment flashes in time with the incoming CW. Use higher **RX THRn** settings for stronger signals as well as faster CW speeds.
- Use a filter bandwidth of **0.30** kHz or less.
- For further details on data modes, see pg. 18.

Programmable Function Switches

Two often-used menu entries can be assigned to programmable function switches **PF1** and **PF2**.

To set up a programmable function switch:

- Hold **MENU** and rotate VFO B to find the target menu entry.
- Hold **PF1** or **PF2** to assign it to this menu entry. You'll see **PF1 SET** or **PF2 SET**.
- Exit the menu.

If a parameter has only two values, accessing it with a **PF1** or **PF2** will change the value and exit menu.

Macros can also be assigned to **PF1** and **PF2**. Macros are sequences of control commands that perform operations such as entering SPLIT mode and moving VFO B up. Refer to the **K3 and KX3 Programmer's Reference** or *KX3utility*.

Split and XIT

Sometimes you'll hear a DX station being called by many other stations. To ensure that he has a clear transmit channel, the DX station may say "UP" or "DOWN" to indicate that he's *listening* above or below his transmit frequency. For example, in CW mode he may transmit on 7025 kHz, but listen in the vicinity of 7027 kHz. In this case he would periodically say "UP 2" (or just "UP") as a reminder of where to call him. SSB split operation is similar but may occur over a much wider range.

To use split, first tap **A ▶ B** twice to set VFO B to the same mode, frequency, and filter settings as VFO A. Then tune VFO B up about 2 kHz. Finally, hold **SPLIT** (the **SPLIT** icon will turn on). The **TX** icon's arrow will now point at VFO B, since VFO B is now controlling your transmit frequency.

Before you transmit using split, you may need to fine-tune your VFO B frequency. Setting it 2 kHz above VFO A is a good start, but many other stations may be trying to call at exactly this same location. The DX operator will be aware of this and will tune up and down from this nominal frequency when searching for callers. He'll probably tune up in small steps as he "picks off" each station.

This is where the **REV** switch comes in: it reverses the A and B VFOs so that you're temporarily *receiving* on your transmit frequency. During this time, tune VFO A around a bit to see if you can identify who is presently working the DX station, then position yourself just above this frequency.

REV remains in effect as long as you hold it down. As soon as you've released it, the VFOs will be swapped back, and you'll once again be listening to the DX station. With any luck your next transmission will occur right where he's listening.

Dual watch with split: With dual watch enabled, you don't need to use **REV**, since you can listen to both your receive and transmit frequencies (pg. 20).

XIT as an alternative to split: If you're trying to preserve VFO B as a holding register tuned someplace else in the band, you may want to use XIT rather than split in the above situation. In this example, you'd turn on **XIT** and rotate the offset control to about +2.00 kHz. You'll then be transmitting 2 kHz above VFO A. To do the equivalent of **REV**, you can briefly turn **RIT** on as well. Turn off RIT to listen to the DX station.

Audio Effects

If you have stereo headphones or stereo external speakers, you can take advantage of the KX3's DSP *audio effects* (AFX). These create an illusion of greater acoustic "space," resulting in a less-fatiguing receiver sound and in some cases better copy of weak signals.

MENU:AFX MD is used to select the desired AFX setting. Available selections include **OFF**, **DELAY** (simulated stereo), and **PITCH** (which "maps" signals from left to right according to pitch).

Dual Watch

Dual watch allows you to listen to both VFO A and VFO B frequencies at the same time, as if you had two receivers.

i The use of stereo headphones or external speakers is required with dual watch. You'll hear VFO A's signal in the left ear, and VFO B's in the right.

Dual watch has various uses. For example, you might be waiting for one station at VFO B's frequency to complete a QSO, while using VFO A to look for other stations. You can tap **[A / B]** to alternate between the two. Dual watch is also ideal for working DX stations who are listening at some offset from their transmit frequency. You can listen to the DX station on VFO B, then use VFO A to listen for a clear spot in which to transmit.

To turn on dual watch: Set **MENU:DUAL RX** to **AUTO**. This turns on the **SUB** ("sub receiver") icon. If you turn dual watch on/off frequently, you may wish to assign it to **PF1** or **PF2** (see pg. 19).

Dual Watch Limitations:

- The distance between VFOs is limited to 15 kHz. If you exceed this with **DUAL RX** set to **AUTO**, the **SUB** flashes slowly as a reminder.
- A wider roofing filter than normal will be selected automatically, if required, based on the frequency span between VFO A and B.
- Dual watch overrides the normal audio effects mode (**AFX MD**).
- Headphones or external speakers must be used.

Receive Audio Equalization (RX EQ)

The KX3 provides 8 bands of receive audio equalization via the **RX EQ** menu entry. RX EQ can compensate for physical acoustics (of the room, headphones, internal speaker, external speaker), tailoring the audio to your personal preference.

Two receive EQ setups are provided: one for CW mode, and the other for all voice modes. RX EQ does not apply to DATA modes.

In the **RX EQ** menu entry, the VFO A display shows 8 individual vertical bar graphs. The example below shows various amounts of EQ for each band.

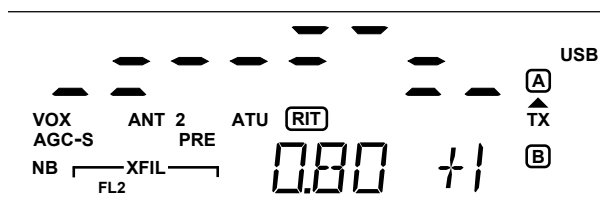

The center frequencies of the 8 audio EQ bands are 50, 100, 200, 400, 800, 1600, 2400, and 3200 Hz. To select a band to change, tap **[1-8]** on the keypad. For example, tapping **[1]** selects the 50-Hz band.

Next, rotate VFO A to specify boost or cut (+/- 16 dB). The illustration above shows the 800 Hz EQ band (**0.80** kHz) being set to **+1** dB of boost.

You can hold **CLR** to reset all of the **RX EQ** bands to **0** dB (no cut or boost).

Transmit Audio Equalization (TX EQ)

⚠ Most microphones, including the Elecraft MH3, will provide good audio quality with little or no TX EQ. High settings can cause distortion.

If required, transmit audio equalization can compensate for microphone and voice variations. **MENU:TX EQ** works exactly the same as **RX EQ**, and can be used during transmit. Two transmit EQ setups are provided: one for SSB, the other for wideband voice modes (ESSB, AM, FM). TX EQ is not applicable to CW or DATA modes.

While adjusting **TX EQ**, monitor your voice using headphones (use **MON** to set the level), or listen to your transmitted signal on another receiver. If you hear distortion, reduce all TX EQ bands. You may also have excessive mic gain or compression.

SSB/CW VFO Offset

The KX3 can automatically offset the VFO frequency when you switch from SSB to CW mode, so other stations will hear the correct CW pitch. See *MENU: CW WGHT* for details.

Digital Voice Recorder (DVR)

You can record two voice messages of up to 15 seconds each, such as your call sign or a CQ, and play them back one time or with auto-repeat.

⚠ Use the transmit voice monitor to hear DVR playback. Hold **MON**, then set the level while speaking into the mic. 5 is a good starting point.

DVR Record: Hold **REC**, then tap **1** or **2** on the numeric keypad. The current message will be erased (4 seconds). When prompted, tap **XMIT** and start speaking into the mic immediately (no need to push PTT). Tap **XMIT** again to terminate record. MIC gain cannot be adjusted during DVR message play. The gain setting at time of recording is used.

DVR Play: Tap **MSG**, then tap **1** or **2**. To cancel, tap **XMIT** or hit the keyer paddle or hand key. To auto-repeat a message, tap **MSG**, but then *hold* rather than *tap* **1** or **2**. *MENU: MSG RPT* sets the repeat interval (1 to 255 seconds).

Transmit Noise Gate

The noise gate function mutes mic audio below a selected audio threshold. This is useful in vehicles and when operating in noisy outdoor environments. See *MENU: TX GATE* for details.

Transmit Inhibit and External PTT

The GPIO pin of the ACC2 connector can be configured as a transmit inhibit or PTT input by setting *MENU: ACC2 IO* to the desired setting.

Cross-Mode Operation and CW-in-SSB

Cross-mode operation is possible in some cases. For example, you could set up VFO A for SSB receive, and VFO B for CW transmit, then enter **SPLIT**.

i You can also send CW when SSB mode is selected for VFO A just by hitting the key. The SSB station will hear the signal at your sidetone pitch. See *MENU: CW WGHT* for details (pg. 35).

Transverter Bands

Nine user-definable bands are provided for use with transverters. These can be used with the Elecraft KX3-2M internal 2-m module, Elecraft XV-Series, or other transverters.

⚠ The KX3 does not have a low-level transverter output; transverters are driven from the main antenna jack. This requires the use of transverters that have a common receive/transmit antenna jack and associated T/R switching. Consult the transverter manual for drive power limitations and switching requirements.

The ACC2 jack provides a keyline output for keying transverters. The ACC2 jack also provides a GPIO pin that can be used to select among multiple transverters based on the band selected at the KX3. This is further explained below.

Transverter Band Setup

Transverter bands are set up using the *XV* menu entries, as follows:

- Locate the *XVn ON* menu entry. Tap **1** – **9** to specify which transverter band to configure. Set the parameter to **YES** to enable band *n*.
- *XVn RF* sets the operating frequency (MHz).
- *XVn IF* specifies the I.F. band (7, 14, 21, 28, or 50 MHz). Use **50** MHz for the KX3-2M option.
- *XVn PWR* sets maximum KX3 power output for the current transverter band in watts (0-1). Use **0.3** watts for the KX3-2M option.
- *XVn OFS* can compensate for frequency offset in the transverter's oscillator. (An offset is not required for the KX3-2M module, since its oscillator signal is derived from the KX3's main synthesizer. If there is a frequency error, calibrate synthesizer using *REF CAL*.)
- *XVn ADR* should be set to **INT TRN 0** for use with the KX3-2M module. It can also be used to specify an optional Elecraft XV-series transverter selection address. Only addresses **TRN1-TRN7** are recognized for this purpose. To select XV-series transverters using this method, set *MENU: ACC2 IO* to **TRN CTRL**, and connect the ACC2 jack's GPIO pin to the transverter's auxBus line.

Special VFO B Displays

The KX3 can continuously display time of day or one of several operational parameters on the VFO B display. To access these displays, tap **DISP**, then rotate the **⊖ OFS/VFO B** control.

The available special displays are listed below.

- **24-hour time** obtained from the real-time-clock on the KXBC3 option module. If a KXBC3 is not installed, the time since last power-on will be displayed. To set the time, use the *TIME* menu entry. You can also set an alarm time anytime in the next 24 hours using the *ALARM* menu function. This may be useful as a reminder of a contest or operating schedule. **The alarm will turn the KX3 on if it occurs when power is off.**
- **Power supply voltage.** This and the next four parameters stay visible even in transmit mode, so you can check key-down conditions.
- **Internal battery voltage.** An asterisk (*) is added to this display during battery charging. See *BAT CHG* menu entry.
- **Supply current.** Typical receive-mode current is 0.15-0.2 amps (150-200 mA). It will be higher with the backlight, preamp, or isolation amp on, or when using the internal speaker. Transmit current is typically 1 to 3 A, varying with band, supply voltage, and load SWR.
- **Power amplifier (PA) temperature.** The PA temperature will rise gradually as you transmit. The KX3 reduces power if the PA is too hot.
- **Synthesizer (OSC) temperature.** Used by the KX3 to adjust the synthesizer (or oscillator) frequency as temperature varies. If the ambient temperature is very low, it can take several seconds for the reading to stabilize, during which some drift in the oscillator frequency may be observed. A few degrees of additional temperature rise is also normal during transmit.
- **Audio Signal level (AFV).** This display shows the approximate level of the KX3's audio output, prior to the AF gain control (in other words, the AF gain control has no effect on the reading). The reading will vary with preamp and attenuator settings as well as the RF gain control. AFV is normally used in conjunction with the **dBV** function (at right).

- **Relative audio signal (dBV).** This display can be used to measure receiver sensitivity or gain/loss of various stages, or compare two signals. To use it, first select **AFV** (described at left) and allow the voltage reading to stabilize. (This may not be possible with modulated or rapidly changing signals.) Once the signal appears stable, select **dBV**. You should now see a reading of around 0 *dBV* (see **Glossary**) relative to the last **AFV** reading. If you change the setting of the preamp or attenuator, you should see this reading change. However, it may not change as much as you expect unless you turn AGC off using the *AGC* menu entry. **(Be sure to turn AF gain down before turning AGC off, as the signal may become very loud.)** Measurement of receive sensitivity (MDS) requires a calibrated 1- μ V signal source such as an Elecraft XG3. These sources include instructions for measuring MDS.

Extended Single Sideband (ESSB)

An increase in SSB voice bandwidth may improve fidelity and reduce listening fatigue. However, this also increases signal bandwidth, and is not appropriate for use when bands are crowded.

ESSB receive

The KX3's normal SSB receive bandwidth is about 2.8 kHz. This can be widened by using the **PBT** control. In voice modes, by default function **I** is low-cut and function **II** is high cut. Tap the control to select function **I** or **II**, and rotate it to adjust the passband. (Also see *PBT SSB*.)

ESSB transmit is set up as follows:

- Locate the *TX ESSB* menu entry. Tap **1** to turn ESSB on, then use VFO A to select the desired transmit bandwidth. The **+** icon will turn on in the mode area of the LCD.
- ESSB, AM, and FM have separate TX EQ from regular SSB, allowing you to optimize the transmit passband for these wider-bandwidth modes. See the *TX EQ* menu entry for details.
- You may wish to assign the *TX ESSB* menu entry to a programmable function switch if you'll be turning it on/off frequently.

Internal Batteries

The KX3's internal battery pack can be used with eight 1.2-1.6 volt AA cells of any type. The pack typically provides 4-6 hours of casual operation, ideal for field use or as backup during power outages. An internal NiMH charger is also available (KXBC3, pg. 24).

Opening the Enclosure

To open the enclosure for battery installation, unplug the KXPD3 paddle, then follow the steps below.

- ① Loosen all four thumb screws. Then slowly pull the halves apart only about 1/4" (6 mm).

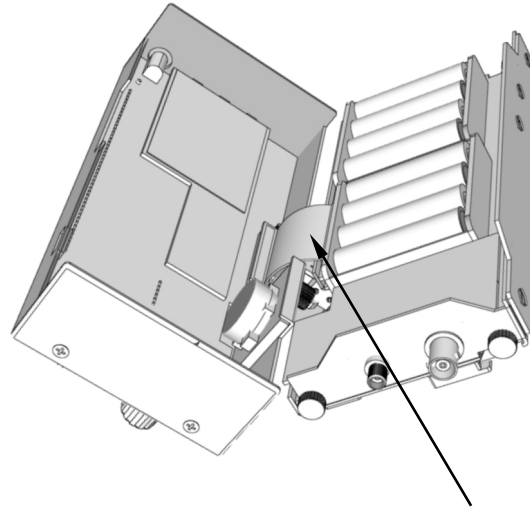
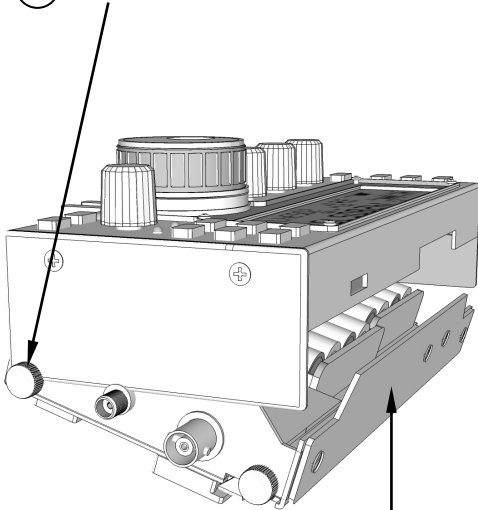

- ② Fold open starting at the back.
- ③ Continue opening. Do not disconnect the flex cable.

⚠ When closing the enclosure, be sure not to pinch the battery wires (red and black). If the flex cable becomes loose at either end, press the connectors back into their sockets.

Recommended Battery Types

Lithium non-rechargeable batteries (e.g., Energizer L91) are expensive, but their flat discharge curve and 3 amp-hour rating provides maximum operating time. In receive, the pack voltage will be about 12 V. In transmit, it will drop to 9-10 V due to the cells' high internal series resistance. This voltage is sufficient for operation at up to 5.0 watts.

NiMH (nickel-metal hydride) batteries have a flat discharge curve, like lithium cells, but a lower pack voltage (typically 10 V receive, 8.5-9 V transmit). Power output of up to 5.0 W is possible, though 3.0 W is recommended to extend battery life. The advantage of NiMH cells is that they can be recharged hundreds of times, either externally (in as little as 1 to 2 hours), or internally (typically 8-12 hours, using the KXBC3 option module).

Alkaline batteries can be used if there's no other alternative, but they have several disadvantages. They should always be used with power output set to 3.0 W or less to minimize transmit current drain. They have a steep discharge curve, so the pack will drop from 12 V to 8 V in about half the time of Lithium or NiMH cells.

⚠ Alkaline batteries are prone to leakage, and must be removed after use. Damage caused by battery leakage is not covered by the warranty.

To maximize Battery Life:

- **Set power to 3.0 W or less when possible.** This uses a high-efficiency transmit mode.
- Turn off the backlight (*BKLIGHT*) and the isolation amp (*RX ISO*) when not needed.
- Use headphones.
- Use the auto-off timer (*AUTO OFF*).
- Use *BAT MIN* to set up an appropriate BAT LOW warning level for your battery type. **Note:** Regardless of the BAT LOW warning level, the KX3 will turn itself off if the power supply or battery goes below 7.5 volts.

KXBC3 Internal NiMH Charger

⚠ Charge only NiMH cells with the KXBC3.

The KXBC3 module provides a convenient way to keep internal NiMH batteries charged. You can operate while batteries are charging.

To ensure safe charging of all NiMH cell types, the KXBC3 uses a “C/10” charge rate (about 200-250 mA, or 1/10th of typical cell capacity in mA-hours). **A 13.8 volt minimum, 500 mA or higher power supply is required to complete a full charge.**

To enable the KXBC3 after installation: Set the *BAT CHG* menu entry from **NOT INST** to **CHG OFF**. Exit the menu. Turn power off and back on.

To start charging: Set *BAT CHG* to the desired charge time. If batteries are fully depleted, use 8-16 hours. Exit the menu.

To cancel charging: Set *BAT CHG* to **OFF**. (This menu entry can be assigned to a programmable function switch; see pg. 19.) If the KX3 is turned off during charging, it will “hibernate,” showing the remaining battery charge time on the display. The KX3 will turn itself off when charging is complete.

Real-Time Clock

The KXBC3’s real-time clock (RTC), powered by the battery pack, shows 24-hour time. Use the *TIME* menu entry to set the clock, tapping 1/2/3 to select HH/MM/SS. Use *ALARM* to set the alarm time. To see time displayed on VFO B, tap **DISP**.

⚠ Preserving clock registers during battery swap: The current time will be preserved during a battery swap if you connect an external supply *or* if you complete the swap within about two minutes. If the time is lost, use *MENU:TIME* to reset it.

VFO Friction Adjustment

The spin rate of the VFO A knob can be adjusted by moving the knob in or out slightly. The rubber finger grip on the VFO A knob covers the knob’s set screw, so it must be removed first.

⚠ In the following procedure, use only your fingernails; a tool may scratch the knob.

Using your fingernails at the point identified below, pull the finger grip forward slightly. Rotate the knob and repeat until the grip can be pulled off.

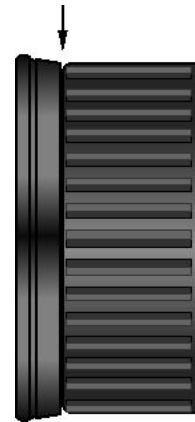

Use the supplied 5/64" (2 mm) Allen wrench to loosen the set screw.

Between the knob and front panel is a felt washer which, when compressed, reduces the spin rate. Move the knob in or out in small increments until the desired rate is obtained. (Re-tighten the set screw each time so you can spin the knob.) Then and replace the finger grip.

Options and Accessories

This section describes all available KX3 options and accessories. Option modules are easily user-installable, in any order, without soldering.

MH3 Hand mic: The MH3 was designed specifically for the KX3. It includes a high-quality mic element, rugged right-angle plug, PTT switch, and VFO UP/DN function buttons.

KXPD3 Keyer paddle: The KXPD3 is an adjustable precision paddle that attaches directly to the front of the KX3. It can be easily removed for storage or transport. The paddles are designed for both left- and right-handed use, and can be electrically reversed or used as a hand-key.

KXBC3 Internal NiMH battery charger and real-time clock: If you install NiMH cells in the KX3's internal battery pack, you can charge them using the KXBC3 module (see **Internal Batteries**, pg. 23). The KXBC3 also includes a real-time clock with an alarm function. The time can be displayed in the KX3's VFO B area by tapping **DISP**. The alarm can be used to turn the KX3 on at a specified time, or to remind the operator of an on-air event.

KXFL3 Dual-bandwidth roofing filter module: A roofing filter is a narrow-band analog filter that better rejects strong signals that could cause receiver blocking (desense) or intermodulation distortion. When the KXFL3 is installed, the KX3 automatically selects the appropriate roofing filter as the bandwidth is adjusted (pg. 12).

KXAT3 Wide-range internal automatic antenna tuner (ATU): With a KXAT3 installed, you can use non-resonant and narrow-band antennas on multiple bands. Using an ATU can improve transmit power transfer as well as receive sensitivity. (See pg. 6 for antenna suggestions.) The KXAT3 also includes an automatically tuned filter for the AM broadcast band that tracks the VFO, improving image rejection for signals in the 0.3-1.0 MHz range.

KX3-2M 2-M module: Provides all-mode, low-power operation on 2 meters. Great for emergency field communications, coordination, etc.

KXPA100 100-W amplifier: The KXPA100 is a rugged 100-W, 160-6 m amp that can be used with any QRP transceiver. An optional internal 100-W ATU is available for the amp (KXAT100).

Firmware Upgrades

New features and improvements are available to all KX3 owners via firmware upgrades. Upgrades may also be required when you install option modules.

Please visit the Elecraft KX3 software page (www.elecraft.com/KX3/KX3_software.htm) to obtain our free firmware download application, **KX3 Utility**. This program runs on PCs, Macs, and Linux platforms. In addition to firmware downloading, **KX3 Utility** provides automated TX gain calibration, a custom sign-on banner, configuration save/restore, CW/DATA message editing, and a CW/DATA terminal function.

⚠ Some applications or peripheral devices may interfere with KX3 downloads; check the Help information in **KX3 Utility** if you have difficulty.

Checking your Firmware Revision

Use the **FW REVS** menu entry to determine your firmware revision. The serial number of your transceiver, if needed, can be obtained using the **SER NUM** menu entry.

KX3 Firmware Self-Test

If the KX3 detects an error in its firmware (an incorrect *checksum* of all bytes in the program), it will flash the **TX LED** and show **MCU LD** on the LCD.

If this occurs, connect the KX3 to your computer, then run **KX3 Utility**, which will reload the firmware. While firmware is loading, the Delta-F LED (Δf) will flash. When the download is complete, the KX3 should reset and run normally.

Forcing a Firmware Download

If you accidentally load an old or incompatible firmware version and find the KX3 unresponsive, do the following: (1) Unplug the KX3 from the power supply. If internal batteries are installed, also remove one battery. (2) Plug a power supply in (or reinstall the removed battery). (3) hold the KX3's **BAND** and **ATU TUNE** together for about 10 seconds, after which you'll see the **TX LED** flash (you'll also see **MCU LD** on the LCD). (4) Connect the KX3 to a computer and run **KX3 Utility**, which will load new firmware.

SDR Applications

The KX3 provides a special receiver output jack, **RX I/Q**, for use with *software-defined radio* (SDR) applications³ running on a computer or other device.

The primary benefit of such applications is that they can provide a real-time display of a band of frequencies above and below the signal to which the KX3 is tuned. You can use this display to quickly find signals of interest, examine modulation and noise characteristics, etc. (This capability can also be found in dedicated instruments called *panadapters* or *spectrum analyzers*.)

Since the KX3's RX I/Q signal is analog, it must be converted to a digital signal by means of a two-channel (stereo) *analog-to-digital converter* (ADC). Most PCs have this in the form of a built-in stereo sound-card. ***It is important that the input to the PC be in stereo.*** Most "mic" inputs are mono, and cannot be used. Most "line inputs" are stereo, and can be used.

If your PC lacks a suitable input, there are third-party soundcards available for USB, PCI, PCIe, Firewire and other expansion buses.

There are many SDR applications available as freeware on various platforms (PC, Mac, iPad, etc.). The quality of the spectrum display they provide depends heavily on the quality of the soundcard's ADC inputs. An excellent reference on potentially suitable sound cards may be found on the web by searching for "LP-PAN sound card tests".

A cable with a 2.5 mm (3/32") plug on one end and a plug that matches your sound card input on the other end (typically 3.5 mm [1/8"] stereo) is required.

Once you have a cable and soundcard, you'll need to download suitable software and load it on your PC. Follow the directions supplied by the program, usually in the form of a help file. There may be user

groups for your program that can help if you have difficulty understanding its installation or operation.

A PC program suitable for most purposes is "HSDR". It is available as of this writing at

<http://www.hdsdr.de>

Follow the directions provided by the HSDR program for setup and operation. Another popular SDR program is "NaP3".

Tips for setting up SDR Programs with the KX3:

- When you first run the SDR program, the frequency displayed may be incorrect, but the spectrum display will still be accurate in terms of offsets. Setting the center frequency display to 1.000 or 10.000 MHz, for example, will make it easy to see how many kHz above or below the current KX3 frequency another signal is.
- Initially connect *only* the IQ signal cable between the KX3 and the PC soundcard. Leave the USB/serial cable for radio control disconnected until you have the spectrum display working properly.
- Select the correct soundcard input for the program. If your PC has an internal soundcard but you are using an add-on card, you must configure the program to use the correct soundcard.
- Set the correct sampling rate. Use of 48 kHz sampling will result in a display of almost 48 kHz: 24 kHz above and 24 kHz below the frequency to which the KX3 is tuned. 96 kHz sampling will yield approximately +/- 48 kHz of spectrum, and 192 kHz sampling will yield a display of about +/- 96 kHz.
- Enable the RX IQ output from the KX3 by setting **MENU: RX I/Q** to **ON**. (This increases the KX3's receive-mode current drain by about 10-15 mA.)
- The RX I/Q outputs from a receiver are not "flat" over an infinite frequency range; the signal-conversion process results in some slope (decrease in gain) as you move farther from the center frequency. In the case of the KX3, the signal will be reduced by about 2.5 dB at +/- 24 kHz, 4 dB at +/- 48 kHz, and 7 dB at +/- 96 kHz. The spectrum amplitude on the display,

³ The RX I/Q jack's analog signal is in *I* and *Q* format. *I* and *Q* refer to the two parts of a phase-quadrature signal, which simply means the two signals are 90 degrees apart in phase. Software applications can use this information to mathematically reconstruct the signals for display and demodulation purposes.

including the apparent noise floor of the receiver, will “roll off” by these amounts.

- If you have an accurate signal level source (such as an Elecraft XG-series signal source or a signal generator), you can calibrate the signal amplitude following directions provided by the SDR program.
- After you are comfortable with setting up and using the spectrum display, you can connect the USB/serial cable between the PC and the KX3.
- Typically, some spectral noise will appear in the display in the form of “spikes” or modulation sidebands. These can arise from several sources, including nearby power supplies, ground noise, or the computer and its peripherals. You can often use isolation transformers, improve grounding, and shielded cables to reduce the amplitude of these signals. **Note: Try setting up without isolation transformers, initially.** They can sometimes add signal pickup that makes the spectrum display much noisier.
- Some low-level spikes may appear in the spectral display that originate at the KX3. These are usually low enough in amplitude to be masked by band noise when a suitable antenna is connected.
- The HSDR program can also display the actual frequency range in use if it is set up to communicate with the KX3. To do this, set up the program to use KX3, K3, or Kenwood protocol using the procedure and support files described on the HSDR website. Connect the KX3’s ACC1 jack to a USB or RS232 port on the computer (see pg. 5). After configuration, the program should then correctly display the actual signal frequencies as you tune the KX3. You may also be able to tune the KX3 from the program, depending on the program’s features.

Remote Control of the KX3

Computer Control and Logging

With appropriate software, any computer with an RS232 or USB port can be used to control the KX3. Required connections are covered on pg. 5.

Third-party logging and contesting software is available for various computers and operating systems. Select KX3 as the target radio when available. If not, select K3 or K2.

For a list of compatible software applications, including configuration requirements, please visit

http://www.elecraft.com/k2_remote.htm

Using the KX3 as a Remote Front Panel

You can use the KX3 as a front panel for a remotely located KX3 or K3. (At present this feature is experimental, providing limited control capabilities.) The two transceivers can be tied together via the internet or WiFi using adapters at each end that handle data and audio. An alternative is to tie the transceivers together directly via the serial port (ACC1), using a “null-modem” cable (a cable with the tip and ring connections swapped from one end to the other).

To enable the remote-control function at the “local” KX3, which acts as a front panel only, set *MENU:AUTO INF* (auto-info) to **RIG CTRL**.

Remote-Control Commands

The KX3 has a rich set of remote-control commands. These commands use ordinary ASCII characters, so they can be easily tested using a terminal emulator or the Command Tester screen in *KX3 Utility*. For example, the command “**FA;**” returns the current VFO A frequency. Using the same command, you can *set* the frequency, e.g. “FA00007040000;” sets the VFO to 7.040 MHz.

Many specialized commands are provided in addition to the core set of commands supported by the K3 and K2. Please refer to the *K3/KX3 Programmer’s Reference* for further details.

Remote Power On/Off

To turn the KX3 *on*, a remote-control system can place 8 to 12 volts DC on the mic jack’s PTT line for 100 ms or longer. (The ACC2 jack’s PTT IN pin

function cannot be used for power-on control. Use only the MIC PTT line.)

To turn the KX3 *off*, the controller must send the KX3 a “**PS0;**” command via the ACC1 jack (RS232 or USB, depending on the cable used). If the controller also turns off the KX3’s power supply, it should first allow 100 ms for the KX3 to shut down.

Automatic Antenna Control

Some antenna control units (e.g., those used with SteppIR™ antennas) can track the KX3’s band and frequency by watching for “**IF;**” (rig information) packets from the transceiver. Some computer logging/contesting applications set up the KX3 to output these messages periodically, allowing the antenna control unit to “eavesdrop.”

If you’re not using such software, or if you’re not using a computer at all, you can still set up the KX3 to output “**IF;**” packets periodically to an antenna controller. To do this, set *MENU:AUTOINF* to **ANT CTRL**. The packets are sent once per second while the VFO frequency is being changed, as well as on any band change.

 If you’re using logging/contesting software, check with the manufacturer before setting *AUTOINF* to **ANT CTRL**. Some applications may not be tolerant of unsolicited “**IF;**” packets.

CW/DATA Terminal Applications

The KX3 directly supports CW/PSK31/RTTY ASCII text transmit and receive via its ACC1 port (RS232 or USB). Our *KX3 Utility* application includes a *Terminal* function that lets you use these modes with your computer’s keyboard and monitor. At the KX3, select FSK-D data submode for RTTY, and PSK-D for PSK31. Then follow the Help instructions within *KX3 Utility*.

K3 Memory Program

The KX3’s frequency memories (pg. 17) can be easily viewed and changed using our *K3 Memory* PC application. This program shows the contents of all 100 regular memories and the per-band quick-memories in a spreadsheet format.

You can also set VFO A directly to a memory from within the K3 Memory program.

Configuration

You'll need to set up **Option Module Enables** (see below) anytime you add one or more option modules. This is done at the factory for factory-installed options.

Some **Menu Settings** (beginning at right) should be set up before you use the KX3 on the air.

Option Module Enables

Whenever an option is installed, use the associated menu entry to set it up (see **Menu Functions**, pg. 35). **When installing internal options, open the KX3 enclosure using the procedure on pg. 23.**

- **KXAT3 Antenna Tuner (ATU):** Set *ATU MD* to **AUTO**. Exit the menu and turn the KX3 off, then back on. See pg. 6 for recommended antennas and pg. 14 for ATU controls.
- **KXFL3 Roofing Filter Module:** Set *RX XFIL* to **NOR**. Exit the menu and turn the KX3 off for 5 seconds, then back on. **You must then perform the Receive Sideband calibration procedure** (pg. 32).
- **KXPD3 Keyer Paddle:** Set *CW KEY2* to **LeFT** paddle = **DOT** (normal) or = **DASH** (reverse). If you set it to **HAND**, either paddle can be used as a hand key. Note that the **KEY** jack on the left side panel is configured using the *CW KEY1* menu entry. The keying device plugged into **KEY** is completely independent of the KXPD3.
- **KXBC3 Internal NiMH Battery Charger:** Set *BAT CHG* to **CHG OFF**. Exit the menu and turn the KX3 off for 5 seconds, then back on. See **Internal Batteries** (pg. 23) for battery recommendations and charging instructions.
- **KX3-2M 2-Meter Module:** See KX3-2M instruction manual and *XVn ADR* menu entry.
- **KXPA100 External 100-W amplifier:** See *PA MODE* menu entry and KXPA100 manual.

⚠ After changing option enables, use *KX3 Utility* to save your present configuration. The configuration can then be restored later if later required.

Menu Settings

The menu entries described in this section can be used to tailor KX3 operation to your own needs. You may also want to review the full list of menu entries, starting on pg. 35.

⚠ After changing menu settings, use *KX3 Utility* to save your present configuration. The configuration can then be restored later if required.

Audio Effects

If you sometimes use stereo headphones or two external powered speakers, try setting the audio effects mode (*AFX MD*) to **DELAY**. (This has no effect on the internal speaker.) **DELAY** creates a simulated stereo effect that can reduce listening fatigue. If you encounter a pile-up of CW signals, try the **PITCH** setting, which “maps” signals from left to right in the audio space based on their pitch.

AM and FM Mode Disable

If you don't plan to use AM and/or FM modes, you can disable them individually using the *AM MODE* and *FM MODE* menu entries.

Auto Power-Off

The KX3 can turn itself off after a specified period of inactivity (i.e., no use of the controls). This is most useful when the unit is running from a small battery. Use the *AUTOOFF* menu entry to select the time period in minutes. The default is **INFINITE**.

⚠ If battery charging is in progress, the KX3 won't turn itself completely off; it will “hibernate” until charging is complete (pg. 24).

Low-Battery Warning

You can set *BAT MIN* to warn you when an internal or external battery is approaching end of charge. **BAT LOW** is displayed periodically when this level is reached. The default voltage (**10.0 V**) is appropriate for many 12-V batteries. For suggested low-battery warning levels for other battery types, see the *BAT MIN* menu entry.

The KX3 will turn itself off when the supply voltage drops below about 7.5 volts, regardless of the *BAT MIN* setting.

Band Map

If there are some bands you don't plan to use, you can remove them from the band-switch rotation using **BND MAP**. This can save time when switching bands. Within the **BND MAP** menu entry, you can switch bands using **BAND+** and **BAND-**. Set each band to **IN** or **OUT** as desired.

CW Iambic Mode

CW users can specify Iambic mode A or B using the **CW IAMB** menu entry. The default is mode **A**, which is a little more forgiving for first-time operators. Mode **B** may be preferred by operators who learned to do “squeeze-keying” with another keyer having this or a similar mode. Both modes provide dot- and dash-memories—enabling fast code speeds—but with slightly different timing.

Microphone Settings

If you plan to use voice modes, set up **MIC BIAS** and **MIC BTN** to match your microphone (pg. 35).

Preamp Gain (Per-Band)

The default (and recommended) preamp gain is **20 dB**. However, you can select **10 dB** if 20 dB is too much gain on a given band. (Operating with the preamp turned off may be a better choice in such cases.) The 10-dB preamp adds about 15 mA to receive-mode current drain, while the 20-dB preamp adds only about 5 mA.

⚠ A **30 dB** selection is also available that turns on *both* preamps. However, this setting increases susceptibility to strong signals. It is the default setting on 6 meters, where the combination of the two can improve sensitivity by 1 to 2 dB.

Switch press Tones

Switch press tones are enabled by default. Using the **SW TONE** menu entry, you can turn tones **OFF**, **ON**, or select Morse code control tones at various speeds (**CODE nn**). The full list of Morse code control characters, as well as a text-only panel description for blind operators, can be found on our KX3 web page.

Switch tones use the CW sidetone volume level, which can be adjusted in CW mode (pg. 12).

Setting the Time

MENU:TIME sets the 24-hour real-time-clock (RTC) if a KXBC3 module is installed. If no KXBC3 is installed, the displayed time will start at **00:00:00** when the KX3 is turned on.

While in the menu entry, tap **1** / **2** / **3** to select HH/MM/SS (hours/minutes/seconds), respectively. Then use VFO A to adjust the value. **KX3 Utility** can also be used to accurately set the time.

Tap **DISP** and rotate VFO B to display the present time.

VFO Setup

Several menu entries are provided to control VFO behavior:

- **VFO CRS** sets up the **KHZ** tuning increment for each mode (coarse tuning) on a per-mode basis.
- **VFO CTS** specifies the number of counts per knob turn (VFO A and B): **128** or **256**. The lower setting makes fine-tuning easier, especially for mobile use. The higher setting allows quicker tuning.
- **VFO OFS**, if set to **YES**, allows the OFS/VFO B knob to do coarse tuning of VFO A. (This only applies if the knob is not being used for RIT, XIT, or to select VFO B display modes. See pg. 35.)

TUNE Power Level

If you're using an external antenna tuner or amplifier with the KX3, you may need to limit the power level used during **TUNE**. The **TUN PWR** menu entry can be used to set the desired power level. For example, with an Elecraft T1 ATU, the best tuner power level is about 3.0 watts.

i If you have the KXAT3 internal ATU installed, power is automatically set to 3.0 watts during antenna tuning. There's no need to configure **TUN PWR** for this purpose.

VOX (Voice Operated Transmit) Setup

If you plan to use VOX in voice modes, you'll need to set up the **VOX GN** and **VOX INH** (anti-VOX) menu entries.

Calibration

A Most calibration steps are performed at the factory for both kit and assembled KX3s.

There is one exception: If you install a KXFL3 roofing filter after initial purchase, you'll need to perform the Receive Sideband calibration step (pg 32).

Viewing tech-mode menu entries: To view the menu entries used during calibration, hold **MENU**, then rotate **⊖** **OFS / VFO B** to locate the **TECH MD** menu entry. Use VFO A to change the parameter to **ON**.

To unlock the parameter for a tech-mode menu entry: Hold **KHZ** until you see the lock symbol (🔒) turn off (about 3 seconds).

Reference Frequency

Using the calibration procedure below, you can achieve accuracy of better than +/- 1 ppm. This procedure requires a stable signal generator, or an on-air signal at a known frequency, such as WWV at 5, 10, or 15 MHz. The carrier of a commercial AM broadcast station can also be used.

i During the procedure, you'll have a choice of two methods for adjusting the reference frequency: **(1) automatic tuning**, or **(2) manual tuning**. Method (2) may be slightly more accurate but requires "zero-beating" of two signals, which some operators may find difficult to do.

- Select CW mode by tapping **MODE**.
- Hold **MENU**. Rotate **⊖** **OFS / VFO B** to find the **DUAL RX** menu entry. Set it to **OFF**, then exit the menu.
- If you're connecting a signal generator to the antenna jack, set **⊖** **PWR** to 0.0 watts to avoid accidental damage to the generator.
- Use direct frequency entry (pg. 10) to set VFO A to the exact frequency of your signal generator or on-air signal source. This will also switch the KX3 to the required band.
- Set AF gain for a comfortable listening level. You should be able to hear a carrier.
- **Method 1 (automatic tuning):** Hold **CWT**. The upper half of the S-meter becomes a tuning aid, with the **CWT** icon turned on. This enables the *auto-spot* function to be used below.

Method 2 (manual tuning): This method requires manually matching the pitch of the received signal to the CW sidetone pitch using **SPOT**. To prepare for this, you may need to increase sidetone volume. See pg. 12.

- Locate the **I/II** icons (right end of the filter passband graphic). If function **II** is selected, tap **PBT I/II** to select function **I** (bandwidth).
- Rotate the **⊖** **PBT I/II** control to set the bandwidth to 0.30 kHz (**BW 0.30**).
- Tap **PBT I/II** to switch to function **II** (shift).
- Rotate the **⊖** **PBT I/II** control until the filter passband is centered in the filter graphic.
- Hold **MENU**, then rotate **⊖** **OFS / VFO B** to locate the **REF CAL** menu entry.
- Hold **KHZ** for about 3 seconds to unlock the parameter (shown on VFO A).
- If you see only 7 digits, tap **RATE**.
- In case you decide to restore the factory setting, write down the full 8-digit parameter value:

- **Method 1 (automatic tuning, CWT on):** Tap **SPOT** to *auto-spot* the signal. The **REF CAL** parameter value should automatically move up or down a small amount. When it finishes moving, the bar directly beneath the **CWT** icon should be turned on as shown below. The reference will then be closely calibrated.

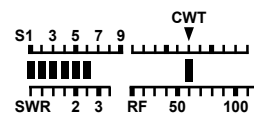

Method 2 (manual tuning, CWT off): Tap **SPOT** and manually adjust the **REF CAL** parameter using VFO A until the received signal pitch matches the sidetone pitch. Adjust for zero-beat.

- If you have difficulty with this procedure, or if you're not sure that it worked correctly, set the parameter value to its original value (recorded above) using VFO A.
- If you have adjusted the **REF CAL** value more accurately, write down the new value (8 digits) here for future reference: _____.
- Exit the menu by holding **MENU**.
- Save your configuration using **KX3 Utility**.

Receive Sideband

Receive sideband calibration nulls (rejects) the *opposite-sideband image*. This image is a weak audible side-effect of very strong signals.

⚠ This calibration step is done at the factory for KX3s shipped with the KXFL3 option at time of purchase, whether factory assembled or kit. It must be performed by the owner only if a KXFL3 is purchased and installed later. Please refer to the instruction sheet supplied with the KXFL3 option.

Transmit Bias

This automated procedure sets the transmit bias current of the 10-watt amplifier stage to ensure low distortion. No test equipment is required.

- Make sure nothing is connected to the KX3's BNC antenna jack.
- Hold **MENU**, then rotate \odot **OFS / VFOB** to locate the *TX BIAS* menu entry. Hold **KHZ** for about 3 seconds to unlock the two parameters. **Note:** These parameters cannot be manually adjusted.
- Select CW mode by tapping **MODE**.
- Tap **XMIT** to start CW bias calibration. This may take 3-10 seconds. If an error message appears at the end (**ERR nnn**), see **Troubleshooting**.
- Select SSB mode (LSB or USB) by tapping **MODE**.
- Tap **XMIT** to start SSB bias calibration.
- Exit the menu by holding **MENU**.
- Save your configuration using *KX3 Utility*.

Transmit Gain

This procedure compensates for per-band transmit gain variations at two different power levels, and must be done on every band. As described below, the procedure can be done manually, or you can use the a fully-automated procedure provided by the *KX3 Utility* program. A 6-watt (minimum) dummy load is required in either case.

⚠ A 12-14 volt external power supply or battery must be used during this procedure.

Automated Transmit Gain Calibration

- If a computer is available, you can use the automated transmit gain calibration procedure. Connect the KX3 to the computer, run *KX3 Utility*, and select the *Calibration* tab.
- Click on **Calibrate Transmitter Gain** and follow the on-screen instructions.
- Save your configuration using *KX3 Utility*.

Manual Transmit Gain Calibration

- Use direct frequency entry (pg. 10) to set the KX3's operating frequency to 1.9 MHz (160 meters).
- If you have the KXAT3 ATU option installed, put it into bypass mode (*MENU:ATU MD*).
- Set the *TUN PWR* menu entry to NOR.
- Connect a dummy load to the BNC jack.
- Set  **PWR** to exactly 4.0 watts (pg. 14).
- Hold **TUNE**; wait until VFO B shows **4.0 W**.
- Tap **XMIT** to exit TUNE.
- **Repeat the above procedure on 80-6 meters.** Use approximately the following frequencies: 3.7 MHz (80 m), 5.4 MHz (60 m), 7.1 MHz (40 m), 10.1 MHz (30 m), 14.1 MHz (20 m), 18.1 MHz (17 m), 21.2 MHz (15 m), 24.9 MHz (12 m), 28.8 MHz (10 m), 52 MHz (6 m).
- **Repeat transmit calibration at 6.0 W on all bands.**
- Save your configuration using *KX3 Utility*.

Transmit Carrier

In SSB and some data modes, a transmitter's primary signal may be accompanied by a weak unmodulated signal called a *carrier* about 1 kHz away. The carrier should be suppressed (or nulled) to minimize interference to nearby stations. The *TXCRNUL* menu entry is used for this purpose.

⚠ This procedure requires a spectrum analyzer and is normally done only at the factory. Complete instructions are available on request.

Transmit Sideband

In SSB and some data modes, a transmitter's primary signal may be accompanied by a weak *opposite sideband* signal about 2 kHz away. This signal should be suppressed (or nulled) to minimize interference to nearby stations. The *TXSBNUL* menu entry is used for this purpose.

⚠ This procedure requires a spectrum analyzer and is normally done only at the factory. Complete instructions are available on request.

Menu Functions

Hold **MENU** to enter the KX3's menu. Tap or hold this switch to exit. Menu entries that you'd like quick access to can be assigned to programmable function switches (pg. 19). **Note:** **NOR** appears in some parameter displays. This means "Normal," i.e. the default or recommended value.

Menu Help Information



Holding **MENU** for about 3 seconds while in the menu shows information about the present menu entry on VFO B. For most entries, the default parameter value is shown in parentheses at the start of the help text. Tap the switch to terminate the help text display.



Tech-Mode menu entries







The  symbol in the table below indicates a *tech mode* menu entry. These are typically used for calibration, and their parameter values are locked by default, as indicated by the lock symbol on the display. To see tech-mode menu entries, set *MENU:TECH MD* to **ON**. To change any tech-mode parameter, you must first unlock it by holding **KHZ** for about 3 seconds. This turns off the lock symbol.

Entry	Default	Description
2 TONE 	OFF	Enables built-in 2-tone generator for SSB transmit tests. The internal 2-tone generator only works if LSB or USB mode is selected. After setting 2-tone ON , exit the menu and tap XMIT .
ACC2 IO	OFF	Determines the function of the GPIO signal (ACC2 jack's "tip" connection): OFF (output, 0 V), ON (output, 3 V), LO=PTT (input; apply 0 V or ground to activate PTT), HI=PTT (input; apply 3 to 5 V to activate PTT), LO=Inh (input; 0 V inhibits transmit), HI=Inh (input; 3 to 5 V inhibits transmit), TRN CTRL (output; XV-series transverter control using Elecraft auxBus protocol). If the GPIO signal is inhibiting transmit, the TX icon will flash as a reminder. NOTE: External interface circuitry may be required. The GPIO pin is a 3-V logic input/output with a 500-ohm series current-limiting resistor. It is tolerant of 0-5.5 VDC when used as an input. If a voltage outside this range is to be used, insert a larger series resistor. (Example: when an RS232 RTS signal is used to activate PTT, use a 2.2 to 10 K series resistor.) When the GPIO pin is used as an output, its 3-V logic high may not be sufficient for use with some equipment. In this case a 3-V to 5-V level translation circuit can be used.
AF LIM	NOR 030	Adjustable AF output limiter for use when AGC is turned off . This can protect your ears if a large signal appears. Signals or noise above the threshold will sound highly distorted due to the limiting action, reminding you to back down the AF or RF gain. Typical settings for those who often turn AGC off are 17 to 23; some experimentation will be required.
AFX MD	Delay	Sets up stereo audio effects (requires stereo headphones or dual external speakers). Set to OFF for no effects. DELAY is quasi-stereo, which provides a very rich audio sound. PITCH does left/right pitch mapping, which can be very effective in CW mode.
AGC MD	ON	Some operators prefer to turn AGC off and control gain manually using the RF gain control; see pg. 12. (When AGC is off, the AGC icons on the LCD change to AGC- , with the "minus" sign meaning "off".) This increases your risk of having an uncomfortably-strong signal appear in your headphones or speaker. To reduce the impact of this, you should set the AF limiter to the desired threshold (see <i>AF LIM</i>). The limiter is only used when AGC is turned off.



















AGC SPD	SLO	This setting is stored per-mode. The default for CW mode is FAST , and for other modes, SLO . The setting is indicated by the AGC S and F display icons.
AGC*THR	007	This menu entry provides access to several AGC parameters, each of which starts with AGC* . For most purposes the defaults will suffice. Tap the 1 through 6 switches to access the following parameters (defaults in parentheses): 1 AGC*THR (007): Threshold at which AGC action begins. A higher number moves the threshold up, providing greater audio dynamic range. 2 AGC*ATK (215): Rate of AGC attack. A lower number than the default provides a softer attack but may also result in overshoot. 3 AGC*HLD (000): Hold time in seconds for voice modes. Prevents AGC decay for a specified time after attack, reducing AGC interaction with signals. 4 AGC*DCY (Fast, 140; Slow, 040): Specifies the decay rate for slow or fast AGC (see AGC SPD menu entry). A larger number means a faster decay. 5 AGC*SLP (015): The higher the slope number, the "flatter" the AGC response is. With a high setting of slope, signals above the AGC threshold will be held close in audio amplitude even if they vary in strength at the RF input. 6 AGC*PLS (NOR): Noise pulse rejection. Prevents the AGC (and S-meter) from charging up on one-shot noise events. Set it to OFF to disable this feature.
ALARM	OFF	Set alarm/Auto-Power-On time. Tap 1 to turn alarm on/off; tap 2 / 3 to set HH.MM . If a KXBC3 option module is installed and an internal battery is installed, time will be maintained when power to the transceiver is turned off. Otherwise the time registers will reset to 00:00:00 on power-up. At the alarm time, the KX3 will emit three short beeps. If power had been turned off, AF output will then be restored to the last-used level.
AM MODE	ON	Set to OFF if AM operation is not planned. You can still copy AM signals using SSB modes even if AM is turned off.
ATU MD	Not Inst	KXAT3 ATU mode (or KXAT100, if connected to the KX3). This is normally set to BYP or AUTO . Modes L1-L8 , C1-C8 , and Ct are used to test the KXAT3's relays and L-network. Tapping CLR clears stored LC data for the present band.
AUTO INF 	NOR	If set to ANT CTRL , the KX3 will send band data ("automatic info") to its ACC1 jack for use with devices such as SteppIR™ antennas. The data is sent on every band change, and once per second if the VFO is being moved. See pg. 28. If set to RIG CTRL , the KX3 will function as a front panel for remote control of a <i>second</i> KX3 (or a K3) via an internet or wiFi connection. See pg. 28.
AUTO OFF	INFINITE	Sets auto-power-off time in minutes (the timer is retriggered when any control is used, and during transmit). If set to INFINITE , power is never turned off. A setting of 5 or 10 minutes is recommended when running from batteries.
BAT CHG	Not Inst	If the KXBC3 option is installed (NiMH charger and real-time clock), set to CHG OFF normally. To charge batteries, used one of the timed-charge settings. See KXBC3 manual for detailed information on battery charging. See pg. 24 for battery installation instructions.
BAT MIN	10.0	Low-battery warning threshold. The default (10.0 volts) is sufficient for use with some 12 V batteries such as gel cells. For eight internal NiMH batteries, a setting of 8.5 V is recommended. For internal alkaline or nonrechargeable lithium batteries, use 9.0 V . If the internal battery or external supply/battery voltage drops below this level, the operator will be alerted with BAT LOW messages every few minutes. The KX3 will turn itself off if the supply voltage drops below 7.0 V. For tips on extending battery life, see pg. 24.
BKLIGHT	ON	LCD backlight on/off. The display is transfective, so it can be seen in sunlight

		with the backlight turned off. Turning it off will extend battery life.
BND MAP	{band} In	Allows you to remove one or more bands from the BAND rotation. Use BAND up/down to select bands, then set them to In or Out using VFO A. (Works with transverter bands, too.) You can still get to mapped-out bands using memory recall, direct frequency entry, or computer-control commands.
COR LVL 	NOR 0.1	Sets the carrier-operated-relay (COR) threshold. The COR is used to detect, and protect the KX3's receiver from, a transmitter being used nearby. 0.1 watts is the default and recommended level. See Troubleshooting for other suggestions.
CW IAMB	A	Iambic keying mode (A or B). The default is mode A , which is a little more forgiving for first-time operators. Mode B may be preferred by operators who learned to do “squeeze-keying” with another keyer having this or a similar mode. Both modes provide dot- and dash-memories—enabling fast code speeds—but with slightly different “element-insert” timing.
CW KEY1	TIP=DOT	Specifies whether the left keyer paddle (<i>tip</i> contact on the KEY jack) is DOT or DASH . A third selection, HAND , allows either tip or ring to function as a hand key, or as an input for an external keying device (keyer, computer, etc.).
CW KEY2	LFT=DOT	Specifies whether the left lever of the optional KXPD3 keyer paddle is DOT or DASH . A third selection, HAND , allows either lever to function as a hand key, or as an input for an external keying device (keyer, computer, etc.).
CW WGHT	1.25	Adjusts element/space timing ratio (weight) for the internal keyer. Additional functions of this menu entry, via numeric keypad: Tap 1 to select SSB -CW (default) or SSB +CW (allows CW in SSB modes). When CW-in-SSB is in effect, tapping the KEYER/MIC knob in SSB mode alternates between keyer speed and mic gain rather than CMP/ALC and SWR/RF transmit metering. CW transmit in SSB mode is not available if SPLIT is on. Tap 4 to select VOX NOR (default) or AUTO OFF . The AUTO OFF setting turns CW VOX <i>off</i> on power-up, avoiding accidental keying by attached PCs, etc. Tap 5 to select automatic VFO offset on SSB/CW mode change (VFO OFS) or no offset (VFO NOR , default). Automatic offset is often used on 6 meters, where mixed-mode QSOs are necessary during fading. Note: Pitch matching will be more accurate if USB is paired with CW REV, and LSB with CW normal.
DUAL RX	OFF	Set to AUTO to enable <i>Dual Watch</i> (pg. 20). The SUB icon will turn on. If the VFOs are not within the required range, the SUB icon will flash slowly. Note: Dual watch only applies when using stereo headphones or dual external speakers.
FM DEV 	3.5	FM voice deviation in kHz. Tap 1 to change the function to PL DEV (PL tone deviation; default 0.36 kHz). To turn on PL tones, use PITCH (pg. 15).
FM MODE	ON	If set to OFF , FM will be removed from the mode selections.
FW REVS	N/A	Rotate VFO A to see firmware revisions: MCU (μC , shorthand for <i>microcontroller</i>), and DSP (dSP).
LCD TST	OFF	Rotate VFO A to turn on all LCD segments for test purposes.
LED BRT	4	In the case where the LCD backlight is turned OFF , this menu entry adjusts brightness of the discrete LEDs (TX, delta-F, OFS, and VFO B LED). Does not set brightness of the LCD backlight itself (for that adjustment, use BKLIGHT).
MIC BIAS	ON	Set to ON for the Elecraft MH3. You may need to try both MIC BIAS settings to see which works best with your mic. Monitor your transmitted signal with another receiver when testing mic audio.
MIC BTN	PTT UP.DN	If your mic has both a PTT switch and UP/DN buttons, set the parameter to PTT UP.DN . This applies to the Elecraft MH3. If the mic has PTT but no UP/DN buttons, use PTT . Otherwise, use OFF . This applies to most headset-mics,

		including the Heil models available from Elecraft. Third-party mics may not have a KX3-compatible PTT (push-to-talk) switch. You can still key the transmitter either by tapping the XMIT switch or by using VOX (pg. 15).
MSG RPT	6	Message repeat interval in seconds (0 to 255). To repeat a message, hold M1 – M4 rather than <i>tap</i> . A 6 - 10 sec. interval is about right for casual CQing. Shorter intervals may be needed during contests, and longer for periodic CW beacons.
PA MODE	OFF	Sets the operating mode for Elecraft KXPA100 amplifier and its internal ATU. Set to ON only if the KX3 is connected to the KXPA100 via the KX3 control cable , which plugs into the ACC1 and ACC2 jacks at the KX3. This allows the KX3 to control the amplifier's output power, ATU tuning, antenna switch, etc. as described in the KXPA100 owner's manual. Set to OFF otherwise. This allows the KX3 to be used with the KXPA100 without the custom control cable, but an amp keying connection is still required from ACC2 on the KX3 to KEY IN on the amplifier. Other PA MODE settings are provided for test purposes (see KXPA100 manual).
PBT SSB	Lo-Hi Cut	Sets up the PBT I and II receive filter functions for SSB mode. Lo Cut and Hi Cut (functions I and II, respectively) are the defaults for SSB. If PBT SSB is set to NOR , then SSB mode will have the same PBT functions as CW and DATA modes (WIDTH and SHIFT).
PREAMP	20 dB	Sets preamp gain to 10 , 20 , or 30 dB on a per-band basis. (30 dB is typically used only on 6 meters, where it improves sensitivity by 1-2 dB. This setting should only be used if necessary, since it increases susceptibility to overload.) There are actually two preamps: the 20 dB low noise amp (LNA) and the 10 dB setting of the <i>isolation amp</i> (see RX ISO , below). Use the 20-dB preamp when possible, since it has a better noise figure and lower current drain. If you select 10 or 30 dB, the isolation amp is turned on, adding about 15 mA to current drain.
REF CAL 	114.nnn.nn	Used to calibrate the KX3's synthesizer; normally this is done at the factory. VFO A is used to set the reference frequency (typically 114.2-114.4 MHz). Refer to pg. 31 for calibration details. Note: If the menu name is REF*CAL , then an extended VFO temperature compensation procedure has been performed. This may be helpful when JT65, WSPR, or other modes are used with the KX3, especially on the higher bands. Instructions can be found on our website. A temperature-stable RF source operating near 50 MHz is required, such as an Elecraft XG50 crystal oscillator.
RPT OFS	600	Sets the transmit offset (in kHz) for repeater operation, from 0 to 5000 kHz. Stored per-band and per-memory. Use ALT to select +/- offset or simplex.
RS232	4800 b	RS232 (or USB) communications rate in bits per second (bps). During firmware download (via the KX3FW PC program), the baud rate is set automatically to 38400 baud, but it is then restored to the value selected in this menu entry.
RX EQ	----- (+0 dB, each band)	Receiver audio graphic equalizer. VFO A is used as an 8-band bar graph, showing boost or cut (-16 dB to +16 dB in 1 dB increments) for each AF band. The 8 bands are 0.05, 0.1, 0.2, 0.4, 0.8, 1.6, 2.4 and 3.2 kHz. Tap [1-8] to select an AF band. VFO A selects boost/cut. Hold CLR to reset all bands to +0 dB. CW and voice mode RX EQ are separate. Not applicable to DATA modes.
RX I/Q	OFF	Set to ON to use the KX3's RX I/Q jack with SDR (software-defined radio) applications (pg. 26).
RX ISO 	OFF	Set to ON if you're using the KX3 nearby other receivers operating on the same band, and a strong carrier from the KX3 is heard when its VFO is tuned to the same frequency as the other receiver's. The isolation amplifier is between the antenna jack and the mixer, preventing leakage from the KX3's local oscillator.

RX NR p 	See descr.	<p>Note 1: Most operators <i>will not</i> need to use this menu entry, which provides fine control of receive noise-reduction parameters. The NR switch function provides convenient control of the most important parameter (wet/dry mix); see pg. 13.</p> <p>Note 2: Even if you do set up NR parameters using this menu entry, you'll still need to use the NR switch to turn NR on/off.</p> <p>Note 3: NR is not available in DATA modes or when AGC is off (see <i>AGC MD</i>).</p> <p>Note 4: Holding CLR while in this menu entry will restore all NR defaults.</p> <p>The letter <p> in the menu name will be either B (beta), D (decay), or M (wet/dry mix). Tap 1, 2, or 3, respectively, to select these parameters. Beta and Decay affect the depth of noise reduction and the time required for the DSP's algorithm to settle. The defaults are recommended, and are stored separately for CW and voice modes. Mix controls how much of the signal is processed (wet) vs. how much is unprocessed (dry). This parameter should be used to set the overall receive noise reduction effect. The NR switch function directly controls the mix.</p>
RXSBNUL 	GAIN nnn	<p>Used to null (reject) the opposite-sideband image signal of each of the KX3's analog filter paths. If the menu name is <i>RXSBNL*</i>, then an extended per-band calibration procedure has been completed. Normally this is done at the factory. This procedure requires a 160-6 meter signal source (such as an Elecraft XG3); instructions are available on our website.</p> <p>Also see Receive Sideband calibration, pg. 32.</p>
RX SHFT 	NOR	<p>Normally the KX3's receive I.F. is 0.0 kHz (NOR setting). If a nearby transmitter (or automobile DC power noise) causes audible artifacts in the KX3's receiver, the I.F. can be shifted up to 8.0 kHz to reduce or eliminate such artifacts. With this setting, dual watch and roofing filters cannot be used. This setting is per-band, and should only be used on affected bands.</p>
RX XFIL	Not Inst	<p>Set to NOR if a KXFL3 filter module is installed. The <i>RXSBNUL</i> calibration procedure must be performed when this module is installed (pg. 32).</p>
SER NUM	N/A	<p>Your KX3's serial number, e.g. 05000. Cannot be changed.</p>
SMTR MD 	NOR	<p>S-meter mode: When set to NOR, turning the preamp or attenuator on/off will affect the S-meter reading. If set to ABS, the S-meter reading will stay fairly constant with different preamp and attenuator settings.</p>
SW TEST 	OFF	<p>To turn on switch test, rotate VFO A until the parameter becomes SCN ADC. Then hold any switch to see its scan row and column ADC reading. You can also rotate any of the four potentiometers to see their associated ADC readings (main/sub AF gain and main/sub RF gain). If the SUB RF pot is mapped to main/sub squelch, you must switch to FM mode to see its readings.</p>
SW TONE	ON	<p>If set to ON, switch presses generate audible feedback tones. If set to CODE nn, Morse code characters are generated on any control activation at nn words per minute. (The full list of Morse code control characters, as well as a text-only panel description for blind operators, can be found on our KX3 web page.) Switch tone volume is the same as CW sidetone volume. It must be adjusted in CW mode, using  MON.</p> <p>Pitch of switch tones and Morse characters: In general, a <i>low-to-high</i> tone pair (or high-pitched Morse) is generated when a switch function is turned on, and <i>high-to-low</i> (or low-pitched Morse) when it is turned off.</p> <p>Some switches do not generate tones because they might interfere with received or transmitted audio.</p>
TECH MD	OFF	<p>Set to ON to view <i>Tech Mode</i> menu entries (those marked with  in this list).</p>
TIME	N/A	<p>Real-time-clock view/set. Tap 1 / 2 / 3 to set HH / MM / SS. To see the time and other displays during normal operation, tap DISP (see pg. 11). Time is only</p>

		maintained if a KXBC3 option module and an internal battery are installed.
TUN PWR	NOR	If set to NOR , TUNE power level follows the POWER knob. Otherwise, establishes a fixed power level for TUNE , overriding the present POWER knob setting. Note1: <i>TUN PWR</i> does not pertain to ATU TUNE , which always uses 2 or 3 watts and is internally controlled. It also does not apply to transverter bands using the low-power KXV3 output (XVTR OUT).
TX BIAS	ppp qq	Transmit bias constants. See Transmit Bias , pg. 32.
TXCRNUL	1 nnnn	Used at the factory to null the transmit carrier on each band. See Transmit Carrier , pg. 34.
TX EQ	+0 dB, each band	Transmit audio graphic equalizer (voice modes only). Functions the same as <i>RX EQ</i> , above. TX EQ can be adjusted during transmit. SSB TX EQ is separate from TX EQ for other voice modes. Not applicable to CW or DATA modes. ⚠ Do not use high settings of TX EQ without carefully monitoring your signal. Most microphones, including the Elecraft MH3, will provide good audio quality with little or no TX EQ. High settings can cause distortion.
TX ESSB	OFF 3.0	Extended SSB transmit bandwidth (3.0 to 4.0 kHz) or OFF . Tap 1 to turn on/off and rotate VFO A to select the bandwidth. (Also see pg. 22.)
TX GAIN	ALC nn	Shows transmit gain constant for the present band and power setting. Two gain constants are used: one for PWR settings of 5.0 watts or less, and the other for PWR settings of 5.1 watts or higher. The gain constants are calibrated whenever the TUNE function is activated at exactly 4.0 or 6.0 W. See Transmit Gain calibration procedure, pg. 33. Transmit ALC can be turned off for 2-tone testing or other purposes by tapping DLY while in this menu entry. (This is NOT necessary for any operational purpose. In DATA modes, ALC is already optimized for low distortion.) When ALC is turned off, a (-) sign is added to the parameter, e.g. -ALC nn . Also, an asterisk is added to the PWR control value when it is being adjusted (e.g. 5.0 W*). In this case, the displayed power level will not change; the control functions as a fine power adjustment, and its effect should be observed with an external instrument.
TX GATE	OFF 0	The TX noise gate can be used to suppress transmitted audio below a certain level, e.g. that of an amplifier fan. Tap 1 within the <i>TX GATE</i> menu entry to turn the noise gate on/off. Use VFO A to set the desired threshold. Since there's no visual indication that transmit audio is below the threshold, you should adjust it using the transmit voice monitor (MON), ideally while using headphones. Set the threshold high enough to cut off transmit audio due to local noise, but not so high that it causes your voice to drop out too frequently.
TXSBNUL	GAIN nnn	Used at the factory to null transmit opposite sideband. See Transmit Sideband , pg. 34.
VFO CRS	Per-mode	Per-mode coarse tuning rate (hold KHZ and tune VFO A or B). Also applies to the RIT/XIT tuning knob if <i>MENU:VFO OFS</i> is set to ON , and both RIT and XIT are turned off.
VFO CTS	256	VFO counts per turn. Use 128 for easier fine-tuning of VFO; use 256 for faster tuning. Note: The KHZ tuning rate always uses 128 counts per turn.
VFO NR	OFF	VFO tuning noise reduction. If VFO tuning noise is heard on a given band, set to ON . The setting is stored per-band. Typically it would be used only on 6 meters or other high-frequency bands. (Also see <i>RX SHFT</i> .)
VFO OFS	ON	If ON , the RIT/XIT offset control can be used to tune VFO A in large steps when RIT / XIT are off and the OFS function of the OFS/VFO B knob is selected. Step sizes vary by mode (see <i>VFO CRS</i>), and are the same as the KHZ tuning rates.

VOX GN	030	Adjusts the sensitivity of the VOX to match your mic and voice. Set to trigger at normal speech level, but not in response to incidental noise. Start with low settings (10-20).
VOX INH	000	Adjusts immunity of the VOX circuit to false triggering by speaker audio. (Also known as anti-vox.) A setting of about 30 is a good starting point. If receive audio from a speaker trips the vox, increase the setting.
WATTMTR 	1.00	Wattmeter calibration parameter. The default setting is recommended. If an external, known-accurate wattmeter reads lower than the KX3's wattmeter, decrease the parameter value (and vice-versa). Note: The ATU (KXAT3), even when bypassed, may cause a small amount of loss (typically less than 0.5 dB). Internal wattmeter accuracy may vary by up to 1 dB, varying with band.
XVn ON 	NO	Tap   to select the applicable transverter band (1 - 9). Set parameter to YES to turn the transverter band on.
XVn RF 	144	Lower edge for transverter band n (1-9); 0-24999 MHz. (Tap   to select applicable transverter band.) Normally, 144 would be used for the K144XV internal 2-m module. But if the K144XV is being used as an IF for a higher-band transverter, you can set it to the lower edge of the higher band.
XVn IF 	28	Specify KX3 band to use as the I.F. for transverter band n (1-9). (Tap   to select the transverter band.) I.F. selections include 7, 14, 21, 28 , and 50 MHz. Use 50 MHz for the K144XV internal 2-m module.
XVn PWR 	H 0.1	Sets upper limit on power level in watts for XVTR band n. Applicable only to external transverters, not the KX3-2M module. Tap   to select band. The KX3 does not have a low-level transverter port, so external transverters must have their own T/R switching and be able to handle the specified power level.
XVn OFS 	0.00	Offset (-9.99 to +9.99 kHz) for transverter band n (1-9). (Tap   to select transverter band.) Compensates for oscillator/multiplier chain errors in external transverters. Not applicable to the internal KX3-2M module, which derives its signal from the KX3's synthesizer.
XVn ADR 	TRNn	Assigns optional band-decode addresses to transverter bands. Addresses TRN1-7 can be used to select Elecraft XV-series transverters if the ACC2 IO menu entry is set to TRN CTRL and the transverters are connected to the ACC2 jack (tip=auxBus, ring=key out). TRN0 is used with the KX3-2M module (internal). Tap   to select the transverter band; rotate VFO A to select the address. To configure an Elecraft KX3-2M 2 m module as XVTR band 1, set XV1 ON to YES , XV1 RF to 144 MHz, XV1 IF to 50 MHz, and XV1 ADR to INT TRN0 . The XV1 OFS and XV1 PWR menu entries are not applicable in this case.

Troubleshooting

The most common symptoms and their causes are listed below, in three categories (general, transmit, and receive). Most problems are related to control settings. If the problem persists, please contact Elecraft support (see pg. 53) or post a question on our email reflector.

General

- **MCU LD shown on LCD and TX LED flashing:** Do a forced firmware load (pg. 25).
- ******* shown on LCD:** This indicates that the KX3 did not power-down correctly. Disconnect power for a few seconds, then try a forced firmware load (pg. 25).
- **Display backlight turns on, but then turns off on release of switches:** Disconnect all external equipment from the KX3. Verify power supply or battery voltage is between 9 and 15 V. Open enclosure and make sure cable between the two main PC boards is fully plugged in at both ends.
- **ERR nnn (error) message appears in the VFO B area:** Refer to **Error Messages** (pg. 45). If a large number of error messages are seen at power-on, re-seat the flex cable between the RF and control boards.
- **BAT LOW is flashed periodically:** Check the battery voltage (tap **DISP** and rotate VFO B until the supply voltage display appears). If the batteries are at their normal voltage, you may have *MENU:BAT MIN* set to the wrong low-battery warning level. See this menu entry for recommendations.
- **Can't turn power on:** Check the power cable. If running from internal batteries, make sure they're installed, seated properly, oriented in the right direction, and charged.
- **Can't turn power off:** If the display remains on, or the unit is otherwise unresponsive, disconnect the power supply. (If internal batteries are in use, remove one battery.) Allow 5-10 seconds, then reconnect power and try turning the unit on.
- **General problem with transmit and/or receive:** Many problems can be caused by low power supply voltage or by a noisy or intermittent supply. Check your power supply's on/off switch, voltage, fuses (if applicable), and DC cabling. The KX3 provides both voltage and current monitoring (pg. 11). Also see *Transmit* and *Receive* troubleshooting sections, below.
- **General problem with firmware behavior:** (1) Check all menu settings (see menu listings in the previous section). In addition to the information in the manual, each menu entry provides help text by holding **MENU** for about 3 seconds. (2) Try loading the latest microcontroller and DSP firmware. Review the release notes for changes that may be related to your symptoms. (3) If the above suggestions don't help, you can try reinitializing the firmware (pg. 44). **Be sure to save your configuration first, using KX3 Utility.**
- Bands missing from **BAND** switch rotation: See *MENU:BND MAP*.
- **N/A message (Not Applicable):** The function you're trying to use does not apply in the present context.
- **Mode icon flashes:** This is a reminder that you're about to set the KX3 up for cross-mode SPLIT operation (VFOs in different modes). Tap any key to clear. To view and change VFO B's mode, tap **A / B**.
- **VFO A frequency doesn't change:** You may have the VFO locked. Tap **RATE** to unlock.
- **VFO A frequency changes by itself:** (1) If using a mic other than the MH3, set *MIC BTN* to OFF. (2) If necessary, adjust the VFO A knob height so that the knob contacts the felt pad (see pg. 24).

Transmit

- **BND END:** Attempt to transmit out of the allowed ham band.
- **TX LED on all the time:** This could indicate that PTT is being held on by external equipment. Try disconnecting everything connected to the left side panel except the power supply. VOX gain (*VOX GN* menu entry) may be set too high. Also check the *ACC2 IO* menu setting.

- **HI CUR or HI SWR warning:** Check supply voltage. If voltage is low and/or a low-impedance antenna load is present, current can go up for a given requested power level. Reduce power if necessary. (The KX3 may do this automatically. If this doesn't reduce the current or reflected power to safe levels, the KX3 will drop out of transmit mode.)
- **HI TEMP warning:** PA heat sink temperature has exceeded the safe operating limit. Use **DISP** to check power supply voltage, current drain, and PA temperature. Allow heat sink to cool. Reduce power if necessary. (The KX3 may automatically reduce power, drop out of transmit mode, or turn itself off.)
- **KX3 enclosure is hot to the touch on the back edge:** During hand-held or lap-top operation at high power or high duty cycle, the enclosure may feel uncomfortably warm. Reduce power or use shorter transmissions. **Note:** At 3.0 watts or lower, the KX3 uses a high-efficiency (lower-current) transmit mode, reducing the rate of heating and extending battery life.
- **An asterisk (*) appears in the PWR setting display (e.g. 5.0 W*):** Transmit ALC has been turned off. To turn it back on, go to **MENU:TX GAIN**, unlock the parameter by holding **KHZ** for 3 seconds, then tap **DLY**. This will turn off the (-) sign in front of **ALC**.
- **Can't transmit in any mode:** The **ACC2 IO** menu entry may be set to **HI=INH** (transmit inhibit when the GPIO pin is pulled high or is floating high).
- **Can't transmit in CW mode:** (1) Make sure the key or keyer paddle is plugged into the correct jack. (2) To transmit immediately upon hitting the key, you must have VOX-CW enabled (hold **VOX**). If VOX is off (PTT-CW), you must tap **XMIT** before sending; otherwise only a sidetone is generated. (3) You may be in **SPLIT** mode, with VFO B set for a voice or data mode. Tap **A/B** to check VFO B's mode.
- **Can't use the mic in voice modes:** You may be in **SPLIT** mode, with VFO B set for CW or data mode rather than a voice mode. Tap **A/B** to check VFO B's mode.
- **Low power output:** (1) Make sure transmit is not inhibited (see **ACC2 IO** menu entry); (2) try redoing the automated **Transmit Gain** calibration procedure (pg. 33). **Note:** Max power varies by band (pg. 52).
- **Inadequate transmit carrier or opposite-sideband suppression:** The voice- and audio-data carrier and opposite sideband will typically be down 60 dB or more at 10 watts output. If either is significantly higher than this level, the **Transmit Carrier** or **Transmit Sideband** calibration steps (pg. 34 and 34) must be performed. These procedures require a spectrum analyzer and are normally done only at the factory.

Receive

- **HI RFI warning, preamp turns off, or RX icon turns on:** The KX3 protects itself from high received signal levels. First, the preamp is turned off, if it was on. (You may be able to avoid this by using the 10-dB preamp rather than the 20-dB preamp on the current band. See **MENU:PREAMP**.) The second step taken by the KX3, if necessary, is to turn on a 15-dB attenuator stage in the I.F. section, ahead of the receiver's A-to-D converter. The receive overload icon (**RX**), near the **ANT** icon, will turn on. Once signals return to a safe level for 5 seconds, this attenuator will be turned back off. Also see **COR** (next item).
- **Carrier-operated relay activated (a relay is heard, and the RX icon turns on):** The carrier-operated-relay (**COR**) may be activated due to the signal from a nearby transmitter. This is usually due to close proximity between your antenna and the other station's antenna. The **COR** is actually the relay for the present low-pass filter. When the relay opens, signals will drop by 40 to 60 dB, protecting the KX3. The relay will close again shortly after the signal drops. If the **COR** is being repeatedly activated, try moving the antennas farther apart. You can also increase the **COR** threshold, at your discretion; see **MENU:COR LVL**.
- **HI CUR warning:** Usually indicates speaker volume is too high; gain is reduced by the KX3 in this case.
- **No received signal:** Check (1) antenna connectors; (2) squelch (FM mode); (3) RF gain too low (set RF gain control fully clockwise, to **-0 dB**); (4) bandwidth too narrow (PBT I/II control); (5) **MENU:REF CAL** parameter not adjusted properly; (6) **KXFL3** menu entry set to **NOR** but module not installed.
- **Received signal level too low:** (1) check headphone and speaker plugs and cables; (2) make sure that **MENU:RX EQ** has not been set for large cuts; (3) verify that **MENU:REF CAL** is properly adjusted; (4) make sure RF gain is set to maximum; (5) preamp set to 10 dB rather than 20 dB (**MENU:PREAMP**).

- **Spurious signals (“birdies”):** All receivers exhibit some birdies. Most will be inaudible with an antenna connected. In the KX3, there may be significant birdies or harmonics of birdies at the following frequencies due to internal signal sources: 16000 and 18432 +/- 5 kHz (MCU and DSP clock frequencies), 300-900 kHz (DC-DC converter oscillators, CMOS RF switches). In the unlikely event that a birdie interferes with operation, try CW reverse, manual notch, or (in voice modes) auto-notch.
- **Opposite-sideband images heard:** Opposite-sideband suppression is 50-60 dB. If images appear too high in amplitude, carefully redo the **Receive Sideband** calibration procedure (pg. 32). If sideband image rejection is poor only for FL2 and/or FL3, but not FL1, the KXFL3 roofing filter module may be at fault.
- **VFO tuning noise heard:** Set *VFO NR* (VFO noise reduction) to **ON** on the affected band, and/or set *RX SHFT* to 8.0. Even with these settings there may be very weak tuning noise heard, especially when no antenna is connected. Dual RX and roofing filters are disabled on any band where *RX SHFT* is set to 8.0.
- **Mobile installation noise:** If the 12-V DC accessory jack in a vehicle causes interference to the KX3’s receiver, try setting *RX SHFT* to 8.0 on the affected band(s).
- **Low-level signals are heard that don’t change as the VFO is rotated:** In a zero-I.F. receiver, it’s possible for extremely strong signals to create audible artifacts, due to AM detection at the mixer, that are not affected by tuning the VFO. If this occurs, first try turning off the preamp (and/or turning on the attenuator). Another alternative is to set the *RX SHFT* menu entry to **8.0** (kHz) on the affected band(s), although with this setting, dual watch cannot be used. If the source of such signals is a nearby transmitter (such as at Field Day), you may be able to reorient or move one of the antennas, or use an external band-pass filter.
- **KX3 VFO signal is heard in a nearby receiver:** If a nearby receiver is picking up the KX3’s VFO signal, turn on the isolation amp (*RX ISO* menu entry). **Note:** This increases current drain by about 15 mA if the isolation amp was not already being used as a 10-dB preamp. Turn *RX ISO* off when not needed.
- **Internal speaker distortion at high volume:** The KX3’s small internal speaker is not intended for use in high-noise environments, such as in a vehicle or outdoors in high winds. If audible artifacts occur at higher volume levels, switch to headphones or an external speaker. (Stereo also allows the use of audio effects.) If you hear distortion products even at low levels, verify that the speaker plug is inserted exactly as shown in Fig. 17 of the KX3 assembly manual. Also try loading new firmware (rev 1.41 or later improves audio).
- **AM broadcast signals in the 300-700 kHz range appear to be off-frequency:** Broadcast signals that appear not to tune in at even multiples of 1 kHz may be *images* of signals higher up in the band. You can eliminate most images by installing the KXAT3 ATU option, which includes broadcast band filtering.

Parameter Initialization (EEINIT)

It is possible, though rare, for EEPROM parameters to become altered in such a way as to prevent the firmware from running correctly. If you suspect this, you can reinitialize parameters to defaults, then restore a previously-saved configuration (or re-do configuration steps manually; no test equipment is required). To initialize:

- **IMPORTANT:** Run the *KX3 Utility* program and use the **Save Configuration** function to save your present firmware configuration. **(Otherwise, you’ll need to re-do calibration steps after EEINIT.)**
- Turn the KX3 off (using the KX3’s on/off switch combination, not your power supply).
- While holding in the **PBT I/II** knob with your right hand (which is also labeled **NORM** below the knob), turn power on with your left hand by holding **BAND-** and **ATU TUNE** together for about 2 seconds, then release. Release the **PBT I/II** knob after another few more seconds. You should see **EE INIT** on the LCD.
- When **EE INIT** completes, you may see **ERR nnn** due to initialization. Tap **DISP** to clear messages.
- Restore all parameters using the **Restore Configuration** function of the *KX3 Utility* program. Then turn power off and on again. See if the original problem has been resolved. If not, contact Elecraft.

Error Messages (ERR nnn)

Error messages may be displayed on VFO B at power-up or during normal operation. In many cases error messages are due to a problem with a single option module or incorrect firmware configuration.

If you see an error message on VFO B (ERR nnn): Write down the error message, as well as any associated error data shown on the VFO A display (e.g. **d=005**). Then tap any switch to clear the error code. Multiple errors may occur; in this case, write down each of the messages and VFO A data, if any, before you clear them.

See Error Message table below for details on specific **ERR** messages and associated data values, if any.

Error Msg	Problem	Troubleshooting steps
ERR ACP	PTT activation via the ACC2 jack detected at power-up	Automatically changes the setting of the <i>ACC2 IO</i> menu entry to OFF (default). If PTT keying via ACC2 is needed, disconnect the device plugged into ACC2, turn power back on, and set ACC2 IO back to PTT setting. If this eliminates the ERR message, the external device may be applying ground to the ACC2 tip contact at all times.
ERR ATC, ERR ATD, ERR ATI	KXAT3 module not accessible: ATC = I/O expander C ATD = I/O expander D ATI = I/O address mismatch	If the module is not actually installed, set <i>MENU:ATU MD</i> to NOT INST . If the module is installed, remove it and re-install it, making sure both connectors are correctly lined up with their mating connectors on the RF board.
ERR ATR	KXAT3 relay failure (on VFO A, d=nnn identifies the failing relay, e.g. 001 for relay K1)	Turn power off for 10 seconds, then back on. Remove and re-install the KXAT3 option module, making sure both of its connectors are correctly lined up with their mating connectors on the RF board. If this doesn't correct the problem, replace the module.
ERR BC3	KXBC3 module error (battery charger/real-time-clock). d=nnn is the specific error code (report to Elecraft).	Turn power off for 10 seconds, then back on. If this doesn't correct the problem, re-seat the KXBC3 module and repeat. If the problem persists, replace the KXBC3.
ERR DS1	No DSP SPI command echo	Turn power off for 10 seconds, then back on. Reload MCU and DSP firmware. If this doesn't correct the problem, <i>save your configuration using KX3 Utility</i> , then perform an EEINIT (pg. 44). If this corrects the problem, restore your configuration using <i>KX3 Utility</i> . If error codes persist, the Control Panel module may have to be replaced. Write down all error codes and associated data values (displayed on VFO A) before contacting Customer Support.
ERR DS2	DSP SPI echo not inverted	
ERR DSE	DSP command timeout	
ERR DSP	DSP, CODEC, or ADC power-up self-test failed	
ERR DSX, DSPT	DSP command timeout	
ERR EE1	On-chip EEPROM read/write test failed	The main microcontroller (MCU) may be defective. Follow the steps shown for ERR DS1.
ERR EE2	External EEPROM read/write test failed	EEPROM may be defective. However, this message may also appear if power is turned off/on too rapidly, or if the power supply voltage "bounces" during turn-on due to inadequate regulation. If the power supply is not at fault, follow the steps shown for ERR DS1.
ERR FW2	General firmware problem. d=nnn identifies the type of error (report to Elecraft).	Follow steps shown for ERR DS1.
ERR IOA, ERR IOB	RF board I/O expander A or B unresponsive.	Turn power off and open the KX3's enclosure. Make sure the cable between the Control Panel board and RF Board is fully seated at both ends and is not damaged in any way.

		Close the enclosure. Turn power on. Reload MCU and DSP firmware. If error codes persist, turn power off, remove all option modules (KXAT3, KXFL3, etc.), and turn power back on. Turn off the associated option module enables in the menu (pg. 35), then turn power off and back on. If this corrects the problem, re-install the option modules one at a time to see which one may be causing the problem. If errors still persist, the Control Panel or RF Board may have to be replaced. Write down all error codes and associated data values (displayed on VFO A), before contacting Customer Support.
ERR KEY, ERR PTT	Attempt to key the transmitter or activate PTT during power-on sequence. (Note: If ERR PTT occurs, VOX transmit is disabled in all modes. Re-enable using the VOX switch.)	Usually caused by an incorrect setting of <i>MENU:MIC BTN</i> for the current microphone, or an external device shorting the KEY or PTT line to ground, or a shorted KXPD3 keyer paddle. Turn power off, then disconnect the KXPD3 (if applicable) and everything plugged into the left side panel, except for the power supply. Turn power back on. If the problem has disappeared, plug devices back in one at a time to see which one caused the error.
ERR OSC	Synthesizer IC unresponsive	Follow steps for ERR IOA.
ERR RFB	RF board may be disconnected from Control Panel board	Follow steps for ERR IOA.
ERR RFK	RF board relay test failure (on VFO A, d=nnn identifies the failing relay, e.g. 001 for relay K1)	Follow steps for ERR IOA.
ERR TX6, ERR TX7	Transmit power MOSFET Q6 or Q7 bias out of range	Follow steps for ERR IOA.
ERR TXG	Transmit gain constant out of range	If this only occurs on one or two bands, there could be a problem with a band-pass or low-pass filter. Also try re-doing Transmit Gain calibration (pg. 33).
ERR TXC, ERR TXS	Transmit attempt without first calibrating TX BIAS in CW (TXC) or SSB (TXS) mode	Perform Transmit Bias calibration (pg. 33). This is a fully-automated procedure that requires no test equipment.
ERR TXN	Transmit attempt without first nulling the carrier on present band	Transmit Carrier calibration must be redone (pg. 34). This procedure requires a spectrum analyzer and is normally done only at the factory.
ERR TXO	Transmit attempt without first nulling the opposite sideband on present band	Transmit Sideband calibration must be redone (pg. 34). This procedure requires a spectrum analyzer and is normally done only at the factory.
ERR TXP	Transmit attempt without first calibrating gain on present band	Follow steps for ERR TXC.
ERR TOS, ERR TPA	Synthesizer or power amplifier temperature sensor out of range	Follow steps for ERR IOA.
ERR VOX	VOX activation detected at power-on	Usually caused by audio at the mic at power-on, with VOX enabled for voice modes. Turn power off, then disconnect the mic. Turn power back on. Turn voice-mode VOX off or reduce VOX gain.

Theory Of Operation

This section includes:

- a functional description of the KX3's RF, control panel, and option PC boards
- block diagram of the KX3 (pg. 49)
- glossary of selected technical terms (beginning on pg. 50)

Additional information including an FAQ (answers to frequently asked questions) can be found on the Elecraft web site.

RF Board

The RF PCB (Printed Circuit Board) contains all of the KX3's RF circuitry as well as low-level baseband (AF) stages in the receive path. The Control Panel (CP) board (following page) generates all digital control signals for band switching, T/R, signal path routing, etc.

The relay-switched **low pass filters** are used during both transmit and receive. A few of the filters are dedicated to one band but most cover two bands. The signal on the antenna side of the filters pass through a forward/reflected power and SWR bridge to the HF-6 meter antenna jack (BNC), or to the optional KXAT3 automatic antenna tuner. Latching relays are used to minimize power consumption.

Transmit/receive (T/R) switching splits the common signal path from the antenna and low pass filters to either the transmitter power amp or receiver input. It also allows sharing the band pass filters between receive and transmit. All T/R switching is done with high-power PIN diodes and CMOS switches to facilitate high speed transitions between receive and transmit.

The synthesized, digitally controlled **local oscillator** (LO) provides quadrature signals to the transmit and receive mixers, as well as a reference signal to the optional KX3-2M module. The LO has very good phase noise performance and can cover a very wide frequency range. Since the KX3 uses a "zero IF" architecture, the KX3's LO frequency is always very close to the operating frequency.

The **RF band-pass filters** are used for both transmit and receive. Filters are selected with low-loss CMOS RF switches. The band pass filters significantly attenuate receive signals at harmonics of the RX frequency, particularly the odd harmonics.

Following the band pass filters and T/R switching are two **RF preamplifiers** and an **attenuator**. These provide various tradeoffs between RF gain and noise figure (or MDS), as well as local oscillator (LO) isolation. The latter would be useful in situations where another receiver in close proximity could be tuned to the same frequency. A problem inherent in most direct conversion (zero IF) receivers is that some LO energy leaks to the antenna and is radiated. This can be a problem when another receiver & antenna is in very close proximity and is tuned to the same frequency. The isolation preamp in the KX3 (*RX ISO* menu entry) virtually eliminates this signal leakage.

The **RX mixer** converts the RF signal to quadrature baseband (AF I and Q signals), which are low-pass filtered and amplified before being passed to the CP board for analog to digital conversion (ADC). I and Q baseband signals (**In-phase** and **Quadrature**) from the mixer are also buffered and sent to the RX I/Q output. This allows attaching the KX3 to a PC or similar device running SDR software (pg. 26).

The main AF amplifier section also interfaces to the optional **KXFL3 filter module** that provides narrower analog filter bandwidths for improved dynamic range performance with nearby strong interfering signals.

The **TX AF Amp and TX mixer** block converts baseband (AF I and Q) modulating signals to an RF signal which is then routed to the T/R switching and band pass filters. This signal provides excitation to the 10W power amplifier. The 10W amplifier (PA) uses a pair of RF power MOSFETs. Temperature monitoring of the

MOSFETS allows automatic reduction of power if they become too hot during long transmit periods at high power levels and high ambient temperature.

The optional **KXAT3 automatic antenna tuner** (ATU) option connects between the BNC antenna jack and the RF board's SWR/power bridge and low pass filters. It uses a latching relay-switched "L network" with eight inductors and eight capacitors capable of matching a wide range of antenna impedances. The KXAT3 also serves as a preselector for operating frequencies below 160 meters, significantly improving reception in the AM broadcast band and below.

Another option, the **KXFL3 roofing filter module**, provides two additional balanced analog filters in the baseband AF I/Q amplifier path. These are much narrower than the default bandwidth. The result is a significant performance improvement in rejecting extremely strong interfering signals that are just a few kHz away from the received signal.

Control Panel (CP) Board

The CP (Control Panel) circuit board contains all of the KX3's control circuitry as well as high-level baseband (AF) stages for the transmit and receive paths. It contains two on-board microcontrollers: one to manage the radio (MCU), and another to process all transmit and receive signals digitally (DSP).

The **DSP** is a 32-bit, floating-point device. All modulation, demodulation, AGC, filtering, equalizing, and other signal processing functions are handled by this IC.

The incoming baseband (audio) signal from the RF board is provided in low-level phase quadrature, or **In-phase and Quadrature (I/Q)**. These signals are digitized by a very low power, high-performance analog-to-digital converter (ADC), then passed to the DSP for processing.

The baseband transmit signal is likewise provided in I/Q format to the RF board. A dedicated, high-performance **digital-to-analog converter** (DAC) is used to generate a very clean transmitted signal.

DSP program storage is by means of a 2 megabyte **FLASH memory** device. This IC also provides storage of operator messages for the DVR function of the KX3 (pg. 21).

Stereo (two-channel) audio from the DSP is converted to analog signals for use with headphones or dual external speakers (PHONES jack). The use of stereo allows special processing to help reduce operator fatigue (**Audio Effects**, pg. 20), and also optimizes **dual watch** capability (pg. 20), where the signals from VFOs A and B are routed to the left and right channels. If the internal speaker is used, the audio is monophonic, and is boosted by a separate speaker amplifier IC. Microphone audio (or low level audio from a computer or other source) uses another ADC that runs at all times to enable voice-operated transmit (VOX) operation.

The **microcontroller unit (MCU)** handles all user interface functions for the KX3, including twenty switches and five shaft encoders. It also handles timing, sequencing, and overall management of the entire radio. The MCU uses EEPROM (electrically erasable, non-volatile memory) to store operator preferences, message keyer (CW/RTTY/PSK) messages, and control settings. A **serial port (ACC1)** provides an interface between the MCU and an attached personal computer (PC), with both RS232 and USB cabling options.

The MCU uses two industry-standard **serial protocols** to control circuits on the RF board. **I²C** (pronounced I-squared-C) controls the synthesizer. **SPI** handles bandswitching, changeover between receive and transmit, etc. The driver for the **liquid-crystal display (LCD)** is also controlled via the I²C port.

The **KXBC3 battery charger** is an optional module that plugs into the CP board. It manages charging of NiMH AA cells (if applicable). The emphasis on the design is safety, so relatively low charging currents are employed. The KXBC3 also incorporates a **real-time clock (RTC)** function, useful for logging and time keeping. The RTC also allows the KX3 to function like a clock radio, turning itself on at a predetermined time (see the **ALARM** menu entry).

KX3 Block Diagram

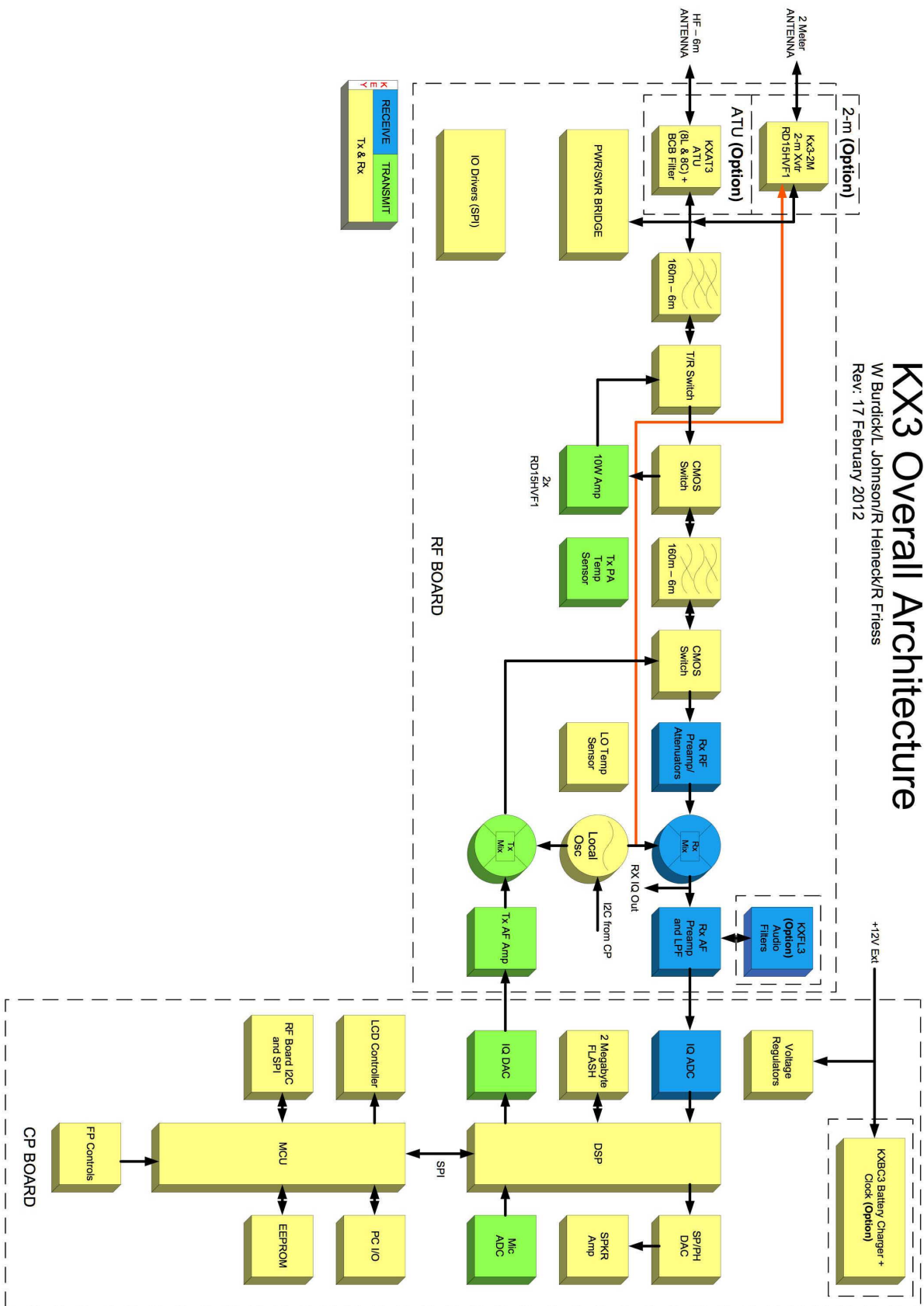

Glossary of Selected Terms

The following terms are often used in the discussion of amateur radio transceivers and related equipment. All are directly applicable to the KX3, which is used here to illustrate some of the concepts. A much larger glossary of terms can be found in the *ARRL Handbook* and on numerous web sites.

A-to-D or ADC (analog-to-digital converter): An integrated circuit that converts analog electrical signals such as audio or RF into digital form. The digital signals can then be processed by a digital signal processor, or *DSP* (see below).

AF, RF, and IF: AF stands for *audio frequencies*—usually, sounds that you can hear. RF, or radio frequencies, are the actual frequencies of the radio signals (or TV, or cell phone, etc.). IF, or intermediate frequencies, are generally somewhere between RF and AF. In a receiver, it is usually advantageous to convert RF signals to a lower IF at which is it more practical to obtain gain or selectivity. These IF signals are then further converted to AF and amplified further so they can be used to drive headphones or speakers.

Attenuator: A circuit that reduces signals to a safe level for use by subsequent stages in a receiver. The KX3 includes two switchable attenuators, one under control of the user (pg. 13), the other switched in automatically as needed (pg. 43, under **COR**).

ATU (automatic antenna tuner): A device inserted between a transmitter (or transceiver) and an antenna that establishes an optimal match between the two, thus allowing full power transfer. (See KXAT3, pg. 25.)

D-to-A or DAC (digital-to-analog converter): An integrated circuit that converts digital signals into analog form, such as audio or RF. Also see *DSP*, below.

dB (decibel): A measure of signal increase or decrease, or of one signal relative to another signal. In human terms, one dB represents a “just noticeable difference” between two signals (or a just-noticeable increase or decrease). Mathematically, dB is derived from the ratio of two signals. Receivers must handle signals over a huge range—in excess of 100 dB. *dBm* is a more specific term that means “dB relative to 1 milliwatt.” 1 milliwatt is considered to be a “0 dBm” signal in this case.

DC-to-DC converter: A device that converts one DC voltage into another. For example, the KX3 includes a very efficient DC-to-DC converter that converts 12 V (nominal) at the DC input jack to 3.3 V for use by its low-voltage circuitry. The advantage of a DC-DC converter is that when it steps voltage down, it steps current up (or vice-versa). In this case, the 300 mA the KX3 consumes at 3.3 V might require only 100 mA at the 12-V power source.

DSP (digital signal processor): A highly specialized numeric computer, implemented on a single integrated circuit, that processes signals digitally. Inputs *to* the DSP must generally be converted from analog to digital form (see *A-to-D*, above), while outputs *from* the DSP must be converted from digital to analog (see *D-to-A*). Use of DSP techniques can result in greater versatility and smaller size compared to the equivalent analog circuitry. The KX3 uses a very advanced, power-efficient DSP.

ESD (electrostatic discharge): An event during which high voltages or currents appear within a radio or other electronic device, potentially causing damage. Antennas, control cables, or the operator’s body are all potential ESD sources. Damage can be avoided through proper handling and grounding techniques.

HF (high-frequency): Signals in the range of 3 to 30 MHz. In amateur radio, *HF* is also shorthand for *160-10 meters* (1.8 to 29.7 MHz), or the “HF bands.” 160 meters actually falls in the *MF* range (0.3 to 3 MHz). The 6-meter band (50-54 MHz) is often included in “HF” transceivers, though it is actually in the *VHF* (*very high-frequency*) range of 30-300 MHz.

IMD (intermodulation distortion): Unwanted signal products that are created in the various stages of a receiver or transmitter. If all stages were entirely “clean,” there would be no IMD. In reality, every stage contributes some distortion, with the amount of distortion being proportional to signal level. Radio designers go

to great lengths to minimize distortion, trading off circuit cost and complexity against the benefit of reduced interference.

Keyer: A device that partially automates the sending of Morse code, allowing for faster code speeds. The KX3 has a built-in keyer function, as well as an optional attached *keyer paddle* (KXPD3, pg. 25).

Linear power supply: A power supply that provides a well-regulated DC output voltage using analog regulator circuitry. An analog regulator uses continuous voltage feedback, and can be designed to generate virtually no noise at radio frequencies, at the expense of power-conversion efficiency. Linear power supplies also typically incorporate a transformer and large filter components (capacitors and inductors), resulting in larger and heavier packages than switching power supplies (see below).

MCU (microcontroller unit): A computer or controller usually integrated onto a single integrated circuit. A modern amateur transceiver usually has one main MCU that controls most radio functions. It may have other smaller MCUs or *co-processors* that perform specific functions. The KXBC3 option module has its own MCU (pg. 25). The DSP in the KX3 is another specialized co-processor (see DSP, above).

MDS (minimum discernable signal): A measure of a radio's sensitivity, expressed in dB (decibels) relative to 1 milliwatt (0 dBm). For example, the user of a KX3 with the 20-dB *preamp* turned on, can typically copy a CW signal at about -137 dBm, or 137 dB *below* 1 milliwatt. MDS is dependent on the receiver bandwidth, with 500 Hz normally used for standardized measurements.

Preamp: A *pre*-amplifier that increases RF signals to a higher level for use by subsequent stages in a receiver. A preamp is generally designed to contribute little noise of its own, so that it improves the noise figure of the radio (also see *MDS*). The KX3 includes two different preamps for use in different situations (pg. 13).

Roofing filter: A filter built with analog components that rejects some out-of-band signals which could cause overload or distortion. The roofing filter appears *ahead* of the A-to-D converter and DSP in a receiver's signal chain, protecting them to some degree. The KX3 has an optional dual roofing filter (see KXFL3, pg. 25.)

SDR (software-defined radio): A radio that performs signal modulation, demodulation, filtering, and other functions in software. The software might execute internally in a dedicated DSP IC, as in the Elecraft K3 or KX3, or externally in a general-purpose computer (pg. 26).

Switching power supply: A power supply that provides a regulated DC output voltage by rapidly injecting current pulses into its load. The duration of the pulses varies with the required load current at any given instant. The *switching rates* used in this type of regulator can be in the hundreds of kHz or even MHz, and their period can vary widely. This is why such power supplies often generate *RFI* (radio-frequency interference) or *hash* if not well-shielded and filtered. Switching supplies are typically much smaller than *linear* supplies (see above) for a given output current, and are used in most PCs and other electronic equipment because of the reduced manufacturing cost. However, much of the RFI heard in amateur receivers originates from switching supplies in nearby gear or even from neighboring houses. The supply that powers the radio itself is especially critical, and a linear supply will often provide better results.

VFO (variable frequency oscillator): A signal source used to select a radio's operating frequency. The KX3's large knob controls VFO A, while a smaller knob controls VFO B (see Using VFOs A and B, pg. 11).

Specifications

GENERAL

Frequency Range	310 kHz - 32 MHz and 44-54 MHz; 144-148 MHz with KX3-2M option. Transmit excluded in some ranges (varies by country). See receiver sensitivity note below.
Frequency Stability	+/- 1 ppm typical over 0-50 C
Antenna	50 ohms; HF: BNC jack; 2 meters: SMA (supplied with KX3-2M option)
Modes	USB, LSB, AM, FM, CW, DATA; built-in PSK/RTTY/CW text decode/display
VFOs	Dual VFOs (weighted VFO A knob); 150+ memories; scanning/channel hopping
Accessory I/O (ACC2 Jack)	KEYLINE: 30 V, 100 mA max, open drain; GPIO: 0-3 V (see ACC2 IO menu entry)
Supply Voltage and Current	8 V min, 15 V max. 1 to 2 A typical in transmit; 150 mA minimum receive, typical (backlight off, preamp off, no signal)
Size and Weight	Size: 3.5 x 7.4 x 1.6", HWD (8.8 x 18.8 x 4.1 cm); weight: 1.5 lbs. (0.68 kg) less options

RECEIVER*

Sensitivity (MDS)	-138 dBm (typ.), 20 dB preamp; -140 dBm typ. on 6 m with 30-dB preamp; -142 dBm on 2 m. (500 Hz bandwidth.) Note: Sensitivity rolls off below 1.8 MHz due to protective high-pass filtering; preamp-on MDS @ 0.55 MHz, 94 dBm (typ.). Image rejection in 0.5-1.5 MHz range can be improved by installing KXAT3 option.
Image and I.F. Rejection	55-70 dB typ. (varies with filter settings, mode, and band)
Audio Output	Internal speaker, 0.5 W typ.; headphones/ext. speaker jack, 0.1 W/channel (stereo)
Receive Features	8 band RX EQ, tunable I.F. passband width/shift, optional roofing filters (KXFL3)

TRANSMITTER*

Output Power	10 W PEP, 160-15 m; 8 W PEP, 12-6 m; 2 m (KX3-2M): 2+ W, 144-148 MHz. Supply voltage of 11 V or higher (on key-down) required for settings above 5 W. 5 W or less recommended for high-duty-cycle modes (FM, AM, DATA). Power will automatically be reduced if PA temperature or current limits are exceeded.
Internal ATU (KXAT3)	8 L/8 C network; matching range typ. 20:1 or higher. Rated power: 15 W. Insertion loss (bypass mode): < 0.5 dB, 160-10 m; < 1 dB, 6 m.
Voice Transmit Features	Split-band, adjustable speech compression; 8-band TX EQ; VOX; 2 DVR messages
CW Transmit Features	Full and semi CW break-in with adjustable delay; diode T/R Switching; 6 messages
Carrier Suppression	> 50 dB typ.
Harmonic / Spurious Outputs	> 50 dB below carrier @ 10 W (> 60 dB on 6 meters)
CW Sidetone/Transmit offset	400-700 Hz, adjustable (receive filter center frequency tracks sidetone pitch)

* Specifications apply only within ham bands except as noted. All measurements taken with 13.8 VDC supply.

Customer Service and Support

Technical Assistance

You can send e-mail to KX3support@elecraft.com and we will respond quickly – typically the same day Monday through Friday. If you need replacement parts, send an e-mail to parts@elecraft.com. Telephone assistance is available from 9 A.M. to 5 P.M. Pacific time (weekdays only) at 831-763-4211. Please use e-mail rather than calling when possible since this gives us a written record of the details of your problem and allows us to handle a larger number of requests each day.

Repair / Alignment Service

If necessary, you may return your Elecraft product to us for repair or alignment. (Note: We offer unlimited email and phone support, so please try that route first as we can usually help you find the problem quickly.)

IMPORTANT: (1) REMOVE BATTERIES before shipping. (2) You must contact Elecraft before mailing your product to obtain authorization for the return, what address to ship it to and current information on repair fees and turn around times. (Frequently we can determine the cause of your problem and save you the trouble of shipping it back to us.) Our repair location is different from our factory location in Aptos. We will give you the address to ship your kit to at the time of repair authorization. *Packages shipped to Aptos without authorization will incur an additional shipping charge for reshipment from Aptos to our repair depot.*

Elecraft 1-Year Limited Warranty

This warranty is effective as of the date of first consumer purchase (or if shipped from the factory, the date the product is shipped to the customer). It covers both our kits and fully assembled products. For kits, before requesting warranty service, you should fully complete the assembly, carefully following all instructions in the manual.

Who is covered: This warranty covers the original owner of the Elecraft product as disclosed to Elecraft at the time of order. Elecraft products transferred by the purchaser to a third party, either by sale, gift, or other method, who is not disclosed to Elecraft at the time of original order, are not covered by this warranty. If the Elecraft product is being bought indirectly for a third party, the third party's name and address must be provided at time of order to ensure warranty coverage.

What is covered: During the first year after date of purchase, Elecraft will replace defective or missing parts free of charge (post-paid). We will also correct any malfunction to kits or assembled units caused by defective parts and materials. Purchaser pays inbound shipping to us for warranty repair; we pay shipping to return the repaired equipment to you by UPS ground service or equivalent to the continental USA and Canada. For Alaska, Hawaii, and other destinations outside the U.S. and Canada, actual return shipping cost is paid by the owner.

What is not covered: This warranty does not cover correction of kit assembly errors. It also does not cover misalignment; repair of damage caused by misuse, negligence, battery leakage or corrosion, or builder modifications; or any performance malfunctions involving non-Elecraft accessory equipment. The use of acid-core solder, water-soluble flux solder, or any corrosive or conductive flux or solvent will void this warranty in its entirety. Also not covered is reimbursement for loss of use, inconvenience, customer assembly or alignment time, or cost of unauthorized service.

Limitation of incidental or consequential damages: This warranty does not extend to non-Elecraft equipment or components used in conjunction with our products. Any such repair or replacement is the responsibility of the customer. Elecraft will not be liable for any special, indirect, incidental or consequential damages, including but not limited to any loss of business or profits.

Index

- ACC1 and ACC2 Jacks, 5
- Advanced Operating Features, 17
- AF Gain Control, 12
- AF Limiter, 35
- AFSK A Mode, 18
- AFV, 22
- AFX (Audio Effects), 20, 29
- AM Mode, 10, 15, 29
- Analog To Digital Converter (ADC, A-to-D), 50
- Antenna, 33
- Antenna Jacks, 6
- Antenna Recommendations, 6
- Anti-VOX, 15
- Attenuator, 13, 50
- Audio Effects (AFX), 20, 29
- Audio Peaking Filter (APF), 13
- Auto Info (AI Mode), 36
- Auto Power-Off, 29
- Automatic Antenna Tuner (ATU), 6, 14, 36, 50
- Auto-Notch, 13
- Auto-Spot, 13, 16
- Band Mapping, 30, 37
- Band Selection, 10
- Bar Graph, 8
- Batteries, 4, 23, 24, 29, 36
- Birdies, 44
- Block Diagram, 49
- Break-In Keying (QSK), 14, 16
- Calibration Procedures, 31
- Carrier Operated Relay (COR), 43
- Channel Hopping, 17
- Charging Batteries, 24
- Clock/Calendar, 39
- Code Practice, 16
- Configuration, 29, 44
- Control Groups, 4
- Cross-Mode Operation, 21
- Crystal Filter Center Frequency, 52
- Current Drain, 11
- Customer Support, 53
- CW Keying Weight, 16, 21, 37
- CW Mode, 16
- CW Reverse, 8
- CW, Break-In (QSK), 14, 16
- CW, Off-Air Keying, 35
- CW, Sending in SSB mode, 37
- CWT, Tuning Aid, 13, 16
- CW-to-DATA, 16
- DATA A Mode, 18
- DATA Mode, 18
- Data Modes, 18
- DATA Reverse, 8
- Date, 30
- dB, decibel, 50
- dBV, 22
- DC-to-DC converter, 50
- Digital Signal Processor (DSP), 50
- Digital To Analog Converter (DAC, D-to-A), 50
- Digital Voice Recorder, 21
- Direct Frequency Entry, 10
- Dual Watch, 20
- EEINIT, 44
- Electrostatic Discharge (ESD), 4, 6, 50
- Error Messages (ERR nnn), 42, 45
- Filter Graphic, 8
- Firmware Upgrades, 25
- FM, 37
- FM Deviation, 37
- FM Mode, 10, 15, 29
- Frequency Memories, 17
- Frequency Range, 52
- Front Panel, 4
- FSK D Mode, 18
- Headphones, 5
- HI CUR Warning, 43
- HI RFI Warning, 43
- HI SWR Warning, 43
- High Frequency (HF), 50
- I/II, 8
- Iambic Keying, 30, 37
- Intermodulation Distortion (IMD), 50
- KAT3, 36
- KDVR3, 21
- Keyboard, 28
- Keyer, 14, 51
- Keyer Paddle, 4, 16, 37
- Keying Weight, 16
- KSYN3, 49

KX3 Utility PC Application, 25, 28, 44
 KX3-2M, 25, 29
 KXAT3, 25, 29
 KXBC3, 24, 25, 29
 KXFL3, 25, 29
 KXPA100, 29
 KXPD3, 25, 29
 LCD Test, 37
 Low Battery Warning, 29, 42
 Low-Pass Filter, 46
 Memories, 17
 Memory Label, 17
 Menu Functions, 35
 Menu Settings, 9, 29
 Message Record/Play, 16
 MH3, 25
 Microcontroller Unit (MCU), 51
 Microphone, 5
 Microphone Gain Control, 14, 15
 Microphone Settings, 30
 Minimum Discernable Signal (MDS), 51
 Mode Selection, 10, 37
 Monitor and Sidetone Level Control, 12
 Noise Blanker, 13
 Noise Reduction, 13
 Notch Filtering, 8, 13
 Option Module Enables, 29
 Options, 25
 Parameter Initialization, 44
 Parameter Save/Restore, 45
 Passband Tuning Control (PBT I/II), 12
 PF1, PF2, 19
 Pot Test (SW TEST), 39
 Power On/Off, 9
 Power Output Control, 14
 Power Supply, 4
 Preamp, 8, 13, 30, 51
 Programmable Function Switches, 19
 PSK D Mode, 18
 PSK31, 18
 PTT (Push To Talk), 15
 QSK, 14, 16
 Quadrature Outputs (RX I/Q), 5
 Quasi-Stereo (AFX), 20, 35
 Quick Memories, 17
 Quick-Start Guide, 7
 Real Time Clock, 30
 Receive Settings, 12
 Reference Oscillator, 31, 38
 Remote Control, 28
 Repeater Offset, 15, 38
 Repeater Operation, 15
 REV switch, 19
 RF Board, 47
 RF Gain Control, 12
 RIT, 40
 RIT/XIT Offset, 11, 40
 Roofing Filter, 12, 51
 RS232, 28, 38
 RTC, 30
 RTTY, 18
 RX EQ, 20, 38, 40, 43
 Scanning, 17
 SDR Applications, 26
 Self-Test, 25
 Serial Number, 39
 Sidetone, 14, 16
 S-Meter, 8
 Software Defined Radio (SDR), 51
 Speaker, 5, 20
 Specifications, 52
Speech Compression (CMP), 14
 SPKRS=1 Warning, 43
 SPLIT and Cross-Mode Operation, 43
 Split and XIT, 19
 Squelch Control, 12, 15
 SSB +CW, 37
 SSB Mode, 15
 SSB/CW VFO Offset, 21
 Standing Wave Ratio (SWR), 6
 Switch Test, 39
 Switch Tones, 30, 39
 Synthesizer, 49
 TCXO, 52
 Tech Mode Menu Entries, 39
 Terminal Emulator, 28
 Text Decode and Display, 16, 19
 Theory Of Operation, 47
 Time, 30
 Transmit Gain Calibration, 33, 40
 Transmit Inhibit, 21
 Transmit Noise Gate (Voice Modes), 21, 40

Transmit Settings, 14
Transverter, 21
Transverter Control, 41
Transverter Operation, 21
Troubleshooting, 42
Tune Power, 30, 40
Tuning Rate, VFO, 30, 40
TX EQ, 20, 40
TX LED, 25, 42
Universal Serial Bus (USB), 5
Variable Frequency Oscillator (VFO), 51
VFO B Parameter Displays, 11, 22
VFO Counts per Turn, 40
VFO lock, 11
VFO Setup, 30
VFO Tuning Controls, 11, 30, 40
Voice Modes, 15
VOX, Voice Modes, 14, 15, 30
Warranty, 53
Wattmeter, 41
XIT, 19, 40