

# ELECRAFT® K3

## HIGH-PERFORMANCE 160 – 6 METER TRANSCEIVER

### K3 KIT ASSEMBLY MANUAL

Rev C, November 15, 2007

Copyright © 2007, Elecraft, Inc.

All Rights Reserved

# Contents

Introduction.....	1
Customer Service and Support.....	1
Technical Assistance.....	1
Preventing Electrostatic Discharge Damage.....	3
How ESD Damage Occurs.....	3
Preventing ESD Damage.....	3
Preparing for Assembly.....	4
Overview of the Kit.....	4
Tools and Test Equipment Required.....	6
Unpacking and Inventory.....	7
Screws.....	7
Standoffs.....	8
Lock Washers.....	8
Assembly.....	9
RF Board and Chassis.....	10
RF Board Description.....	10
RF Board and Chassis Assembly Procedure.....	10
KANT3 or KAT3, Right Side and Rear Panels.....	18
KANT3 or KAT3 Description.....	18
KANT3 or KAT3, Right Side and Rear Panel Installation Procedure.....	18
KIO3 Interface.....	23
KIO3 Description.....	23
KIO3 Interface Installation Procedure.....	23
Front Panel and DSP.....	26
Front Panel and DSP Description.....	26
Front Panel Assembly Procedure.....	26
Resistance Checks.....	39
Initial Power On Check.....	40
KREF3 Reference Oscillator.....	40
KREF3 Description.....	40
KREF3 Installation Procedure.....	40
KSYN3 Synthesizer.....	42
KSYN3 Description.....	42
KSYN3 Installation Procedure.....	42
Loudspeaker.....	43
Loudspeaker Description.....	43
Loudspeaker Installation Procedure.....	43
KPA3 Shield.....	46
KPA3 Shield Description.....	46
KPA3 Shield Installation Procedure.....	46
Bottom Cover.....	48
Bottom Cover Description.....	48
Bottom Cover Hardware Installation.....	48
KNB3 Noise Blanker.....	50
KNB3 Noise Blanker Description.....	50
KNB3 Installation.....	50

Battery BT1 .....	51
Battery BT1 Description .....	51
Battery BT1 Installation Procedure .....	51
KBPF3 General Coverage Receive Option .....	52
KBPF3 Description .....	52
KBPF3 Installation .....	52
Power Amplifier Jumper Block .....	53
Finishing the Enclosure .....	53
Fan Opening Cover .....	53
Bottom Covers .....	54
Top Cover .....	55
Test and Calibration .....	57
Initial Power Checks .....	57
Synthesizer Calibration .....	57
Filter Setup .....	57
TX Gain Calibration .....	58
Option Modules .....	58
Enable Modules .....	58
KPA3 100-Watt Amplifier Installation .....	58
Optional Calibration Procedures .....	58
Wattmeter Calibration (Optional) .....	58
Reference Oscillator Frequency Calibration (Optional) .....	58
S-Meter Calibration (Optional) .....	58
Appendix A, Illustrated Parts List .....	A1

# Introduction

This manual will guide you through assembly of your Elecraft K3 transceiver. We're confident that you'll find the K3 easy to build, even if you've had no prior kit-building experience.

Every modern transceiver is complex, and the K3 is no exception. The kit includes nearly 300 individual components, including over a dozen PC boards and a multi-element modular chassis. But the K3's unique design eliminates some of the tedious aspects of construction, enabling you to complete assembly in far less time than previous high-performance transceiver kits. Also, virtually all of the alignment is handled in firmware using the K3's built-in test capabilities.

If you should have any difficulty, you'll have our full support via phone and e-mail. In addition, we hope you'll join our growing and enthusiastic community of owner/builders via the Elecraft reflector.

Further information about the Elecraft K3, including specifications, installation, and operation instructions, can be found in the Owner's Manual.

## Customer Service and Support

### *Technical Assistance*

You can send e-mail to [support@elecraft.com](mailto:support@elecraft.com) and we will respond quickly - typically the same day Monday through Friday. Telephone assistance is available from 9 A.M. to 5 P.M. Pacific time (weekdays only) at 831-662-8345. Please use e-mail rather than calling when possible since this gives us a written record of the details of your problem and allows us to handle a larger number of requests each day.

### *Repair / Alignment Service (We want to make sure everyone succeeds!)*

If necessary, you may return your Elecraft product to us for repair or alignment. (Note: We offer unlimited email and phone support to get your kit running, so please try that route first as we can usually help you find the problem quickly.)

**IMPORTANT: You must contact Elecraft before mailing your product** to obtain authorization for the return, what address to ship it to and current information on repair fees and turn around times. (Frequently we can determine the cause of your problem and save you the trouble of shipping it back to us.) Our repair location is different from our factory location in Aptos. We will give you the address to ship your kit to at the time of repair authorization. *Packages shipped to Aptos without authorization will incur an additional shipping charge for reshipment from Aptos to our repair depot.*

## Elecraft 1-Year Limited Warranty

This warranty is effective as of the date of first consumer purchase. It covers both our kits and fully assembled products. For kits, before requesting warranty service, you should fully complete the assembly, carefully following all instructions in the manual.

**What is covered:** During the first year after date of purchase (or if shipped from factory, date product is shipped to customer), Elecraft will replace defective or missing parts free of charge (post-paid). We will also correct any malfunction to kits or assembled units caused by defective parts and materials. Purchaser pays inbound shipping to us for warranty repair, we pay shipping to return the repaired equipment to you by UPS ground service or equivalent to the continental USA and Canada. Alaska, Hawaii and outside U.S. and Canada actual return shipping cost paid by owner.

**What is not covered:** This warranty does not cover correction of kit assembly errors. It also does not cover misalignment; repair of damage caused by misuse, negligence, or builder modifications; or any performance malfunctions involving non-Elecraft accessory equipment. The use of acid-core solder, water-soluble flux solder, or any corrosive or conductive flux or solvent will void this warranty in its entirety. Also not covered is reimbursement for loss of use, inconvenience, customer assembly or alignment time, or cost of unauthorized service.

**Limitation of incidental or consequential damages:** This warranty does not extend to non-Elecraft equipment or components used in conjunction with our products. *Any such repair or replacement is the responsibility of the customer. Elecraft will not be liable for any special, indirect, incidental or consequential damages, including but not limited to any loss of business or profits.*

# Preventing Electrostatic Discharge Damage

There is no climate or work location where the components of your K3 are safe from Electrostatic Discharge (ESD) unless you take specific steps to prevent such damage. Many of the components in your K3 can be damaged by static discharges of only a few volts: far too little for you to notice. It is those low-voltage but destructive discharges that easily happen anywhere and under virtually any environmental conditions.

ESD damage may not be apparent at first. The damaged components may not fail completely. Instead, the damage may result in below-normal performance for an extended period of time before you experience a total failure.

## How ESD Damage Occurs

Whenever an object containing a static charge touches a circuit in your K3, current will rush into the circuit until the components reach the same voltage as the source of the static charge. If the voltage or current that passes through a component in your K3 during that brief period exceeds its normal operating specifications, it may be damaged or destroyed.

## Preventing ESD Damage

ESD damage cannot occur if there is no voltage difference between the components in your K3 and any object that touches them. That is how anti-static packaging works. Anti-static bags allow the static charge to flow over their surface, so that any part of the bag that touches the components inside are all at the same potential at all times. Anti-static foam keeps the leads of sensitive components at the same potential.

At your work bench, avoiding a dangerous voltage is achieved most easily by tying everything together and connecting them to a common mains safety ground. This includes your K3, individual boards or other sensitive components as well as everything they may touch at the work table.

Inexpensive static dissipating work mats are readily-available that will steadily and safely drain off any charges built up on parts or circuit boards placed on them. They are supplied with a lead that connects the mat to the common workbench ground. Also, metal cabinets on test equipment used on the bench should be tied together and connected to the common ground.

Most importantly, you must have a way of continuously draining off any static charges that occur on your body. Such charges are easy to create, even while sitting quietly at the work bench. Moving your feet on the floor, shifting position in your chair or even moving your arms so that clothing rubs against itself can all produce destructive static charges. You can discharge yourself by touching an unpainted metal ground, but that will last only until you move in a way that produces a new static charge. The safest technique is to wear a grounded wrist strap with a series 1-megohm resistor that continuously drains off any charges. Such wrist straps are readily-available and inexpensive.

### **WARNING**

**DO NOT attach a ground directly to yourself without a current-limiting resistor as this poses a serious shock hazard. A wrist strap must include a 1-megohm resistor to limit the current flow. If you choose to touch an unpainted, metal ground to discharge yourself, do it only when you are not touching any live circuits with your other hand or any part of your body.**

We strongly recommend you take the following anti-static precautions (listed in order of importance) to avoid trouble:

- Leave ESD-sensitive parts in their anti-static packaging until you install them. The packaging may be a special plastic bag or the component's leads may be inserted in conductive foam. Parts which are

especially ESD-sensitive are identified in the parts list and in the assembly procedures.

- Wear a conductive wrist strap with a series 1-megohm resistor. If you do not have a wrist strap, touch a ground briefly before touching any sensitive parts to discharge your body. Do this frequently while you are working. You can collect a destructive static charge on your body just sitting at the work bench. **DO NOT attach a ground directly to yourself as this poses a serious shock hazard.**
- Use a grounded anti-static mat on your work bench.
- If you choose to use a soldering iron to work on your K3 for any reason, be sure the iron is ESD-safe with a grounded tip tied to the same common ground used by your mat or wrist strap.

## Preparing for Assembly

### Overview of the Kit

The kit comprises two major assemblies: the main chassis and the front panel. Figure 1 shows an assembled K3/10 with its top cover removed.

The main chassis is literally built up around the RF circuit board, which fills the entire bottom of the unit of the chassis assembly. Panels are mounted around the RF board using Elecraft's 2D fasteners. These fasteners allow individual removal of any one panel, if needed, to gain access to the inside of the radio for servicing. Very few cables or wires are used in the kit. Most of the other boards and optional accessories plug directly into the RF board or one of the boards mounted on the RF board.

The front panel assembly, including the display and main operator controls, includes the front panel board and the digital signal processing (DSP) board.

There are many options that you can add to the basic K3/10, such as the 100 watt amplifier module, internal antenna tuner, second receiver, additional crystal I.F. filters, etc. If you purchased these options with your K3 kit, you will find instructions to install them at proper places in the assembly procedure to make getting your complete K3 together and operational in the most efficient manner.

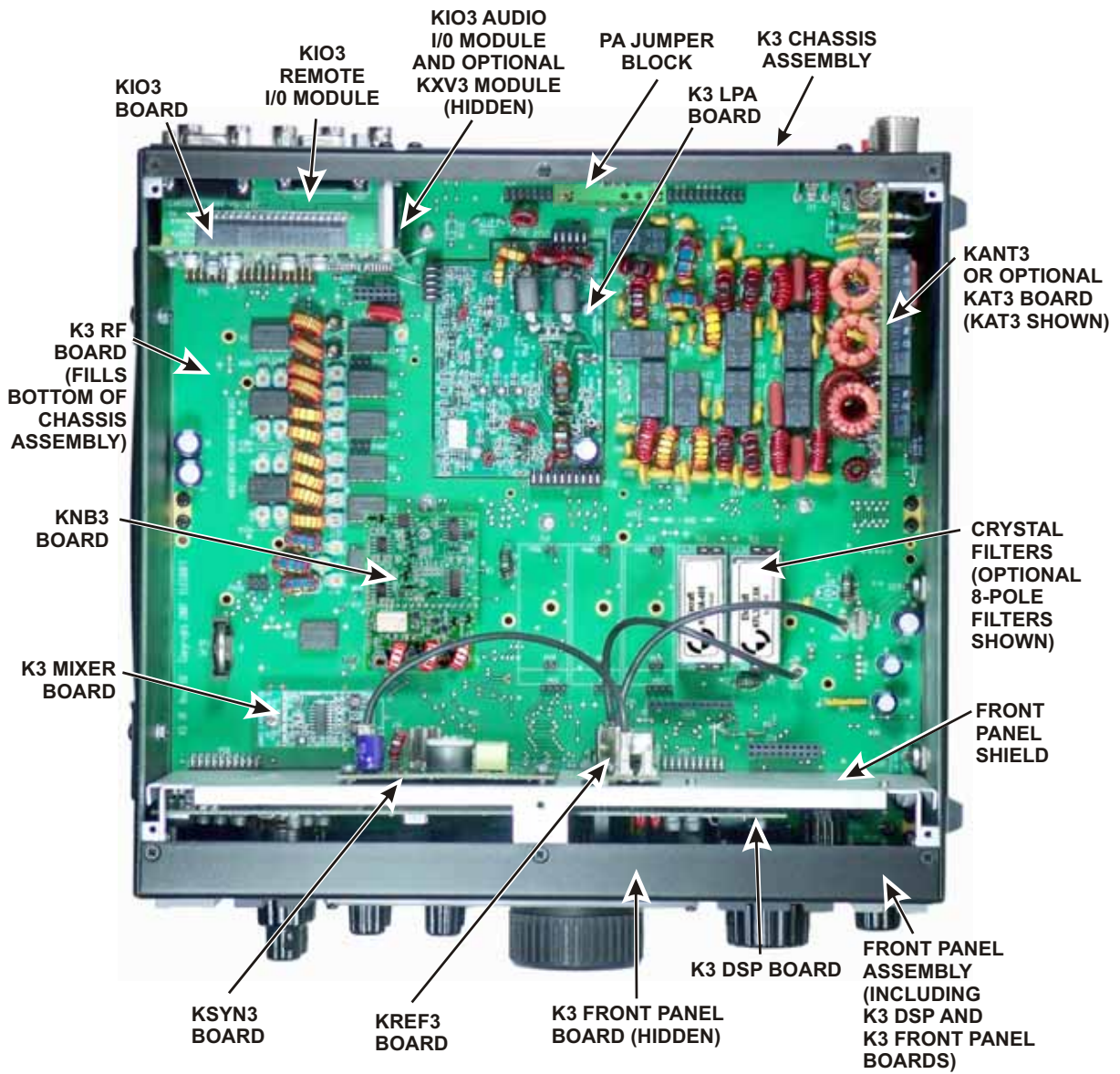


Figure 1. Assembled K3/10 (Less Top Cover).



## Tools and Test Equipment Required

1. #0 and #1 size Phillips screwdrivers. To avoid damaging screws and nuts, ***do not use a power screwdriver***. Use the screwdriver that best fits the screw in each step.
2. Soft cloth or other surface lay cabinet panels on to avoid scratching. A clean static-dissipating mat is ideal (see below). ***If using cloth, do not lay circuit boards on it. See Preventing Electrostatic Discharge Damage on page 3.***
3. Pliers or suitable wrenches for tightening 1/4", 3/16" and 1/2" nuts. The 1/2" size is used to tighten nuts on the front panel controls. If available, a deep socket or nut driver is recommended. Pliers or an ordinary wrench can be used, but requires care to avoid damaging the front panel paint.
4. Long nose pliers.
5. Diagonal cutters.
6. Small rule capable of measuring lengths up to 1" (2.5 cm) with an accuracy of at least 1/16" inch (1.6 mm).
7. Digital Multimeter (DMM) for voltage and resistance checks.
8. RF 50-ohm, 5 W (minimum) dummy load with low VSWR from 160 meters through 6 meters.
9. Power supply 13 VDC nominal (11-16 V) with a cable and Anderson PowerPole® connector. A power cable kit is provided with your K3 if you do not have a suitable cable with the required Anderson PowerPole connector. The power supply must be capable of providing at least 3 Amperes for a K3/10 and 20 Amperes for a K3/100. (See *Specifications* in your Owner's manual for more information on power supply recommendations).

The following tools are strongly recommended:

1. ESD wrist strap.
2. Static dissipating work mat.

Optional Equipment:

1. RF Power Meter with accurate readout from 1 mW to 5 watts, minimum.
2. Signal generator with calibrated 50 uV output at 20 or 40 meters.

In addition, two Allen wrenches, 5/64" (2mm) and .050", are supplied with your kit.

# Unpacking and Inventory

## CAUTION

**Do not handle the circuit boards without anti-static protection! Doing so may damage sensitive components. See *Preventing Electrostatic Discharge Damage* on page 3 for important information before proceeding.**

Before starting construction, do a complete inventory, comparing the parts in your kit with the parts list in Appendix A, to familiarize yourself with all of the parts and to ensure the kit is complete. Note that you may find some extra screws, nuts and washers. A few extras of the more easily lost parts are included on purpose.

All dimensions given in the assembly procedure are provided in both US customary (often called English) and metric measurements. The native dimensions of the parts are in US Customary units. Approximate metric equivalents are given to assist those more familiar with that system to identify the correct parts.

### Screws

A number of different types and sizes of screws and washers are used in the assembly. It is very important that you use the screw specified in each location or your finished K3 may not fit together properly. In some places, using the wrong size screw may damage components. The following various screw types and sizes specified in the text are shown in Figure 2. Images are shown for comparing relative sizes. They are not to scale. The length of the screws called for in the text are measured as shown.




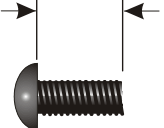






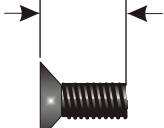


SCREW AS IDENTIFIED IN TEXT	RELATIVE SIZE (NOT TO SCALE)	MEASURING SCREW LENGTHS
2-56 5/32" (4.0 mm) BLACK PAN HEAD		FROM BOTTOM OF PAN HEAD TO END OF THREADED SHAFT
2-56 1/4" (6.4 mm) BLACK PAN HEAD		
4-40 3/16" (4.8 mm) BLACK PAN HEAD		
4-40 3/16" (4.8 mm) BLACK FLAT HEAD		
4-40 1/4" (6.4 mm) BLACK PAN HEAD		FROM TOP OF FLAT HEAD TO END OF THREADED SHAFT
4-40 3/8" (9.5 mm) BLACK PAN HEAD		
4-40 1/4" (6.4 mm) ZINC PAN HEAD		
4-40 3/8" (9.5 mm) BLACK FLAT HEAD		
4-40 7/16" (11 mm) ZINC PAN HEAD		
4-40 1/2" (13 mm) BLACK FLAT HEAD		
6-32 1/2" (13 mm) BLACK PAN HEAD		

Figure 2. Screw Sizes Used in Assembly.

### ***Standoffs***

A number of threaded standoffs are used. As with the screws and washers, be sure you use the correct size as specified in the text. Standoff lengths are measured from end to end as shown in Figure 3. Standoffs threaded for 2-56 and 4-40 screws are used.

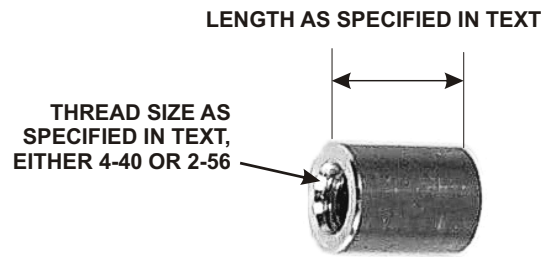


Figure 3. Typical Standoff.

### ***Lock Washers***

Two types of lock washers are used in the K3 (see Figure 4). It is important that you use only the type specified and put the washers exactly where indicated. Failing to use the correct type may result in short circuits to nearby circuit traces. Adding washers or placing the washers in the wrong position may cause parts to fail to fit together properly.



Figure 4. Lock Washers.

# Assembly

## **IMPORTANT ASSEMBLY INFORMATION**

1. A variety of screws and fasteners are used to assemble your K3:
  - **Use your rule to check the length of screws and standoffs before installing them.** Some components are only 1/16” different from others but using the wrong size may result in parts not fitting correctly, possibly damage electrical and mechanical components. See *Screws* on page 7 and *Standoffs* on page 8 for more measurement instructions.
  - **Loosen screws as needed for a proper fit.** When mounting parts with multiple screws or adjacent parts that fit together, such as the exterior cabinet panels, loosen adjacent mounting screws as needed to adjust the parts for the best fit. Be certain you re-tighten the screws before proceeding!
  - **Ensure all screws are tight.** A loose screw can cause both mechanical and electrical problems such as intermittent operation, unexpected noise or false signals (birdies) in the receiver.
  - **Threads can be easily stripped** if too much force is applied when tightening screws. Use the correct size hand tool and apply only moderate torque. Do not use a power screwdriver!
2. Brief circuit descriptions are provided through the manual for those interested in the functions of the circuits. For more detailed circuit information, consult the Theory of Operation in your Owner’s manual.

## **CAUTION!**

### **DO NOT DISTURB ANY ADJUSTMENTS ON THE BOARDS!**

**Each board was tested and aligned for optimum performance at the factory. Any change to these adjustments will degrade the performance of your K3 or prevent its operation altogether. All user calibrations and adjustments are done in firmware using the front panel menus. These are described at the appropriate points in the assembly procedures.**

### **ESD SENSITIVE!**

**Observe ESD precautions when handling the circuit boards and whenever you are working on your K3 with the covers off. Failure to observe ESD precautions may result in your K3 not operating at all, or operating but not meeting normal factory performance specifications due to damaged components. See page 3 for more information.**

## RF Board and Chassis

### RF Board Description

The RF PCB (Printed Circuit Board) is the heart of the K3 transceiver, both physically and electrically. During assembly, it serves as an attachment point for other PCBs as well as chassis panels, acting as the glue that holds things together. During operation, the RF board provides signal routing to and from all modules. For more information, see *Theory of Operation, RF Board*, in the K3 Owner's Manual.

### RF Board and Chassis Assembly Procedure

Remove the RF board from its anti-static packaging. The top side of the board is the side with the toroid inductors and relays along with other components, including several connectors along one edge. The edge with the connectors is the back edge of the board, while the front edge has notches cut in it that will fit around front panel controls. Locate the six rectangular bare copper pads for the 2D fasteners (see Figure 5). There is one in each corner of the board and one in the center of each side (see Figure 11 on page 14).

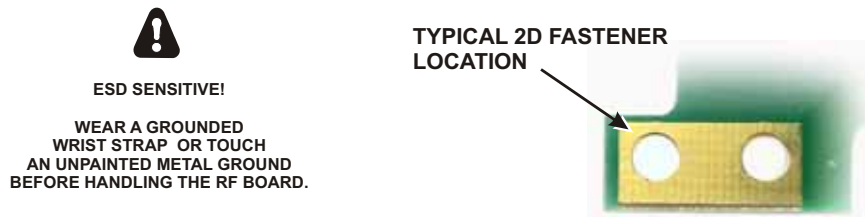


Figure 5. 2D Fastener Location on RF Board.

Install 2D fasteners at the six spaces provided (one at each corner and at the center of each side of the RF board). Mount the fasteners on the *bottom* side of the board as shown in Figure 6. Be sure the 2D fasteners are oriented so the side of each fastener lines up with the edge of the RF board as shown.

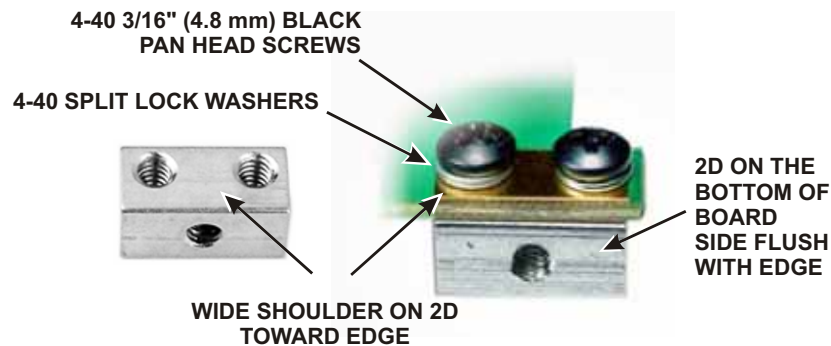


Figure 6. Installing 2D Fasteners on RF Board.

☐ Install a 4-40 3/8" (9.5 mm) standoff on the RF board near connector Z1 as shown in Figure 7 below and Figure 11 on page 14. This standoff will support the mixer to be installed later. Install the standoff using *three* lock washers as shown below with two of the lock washers between the standoff and the RF board.

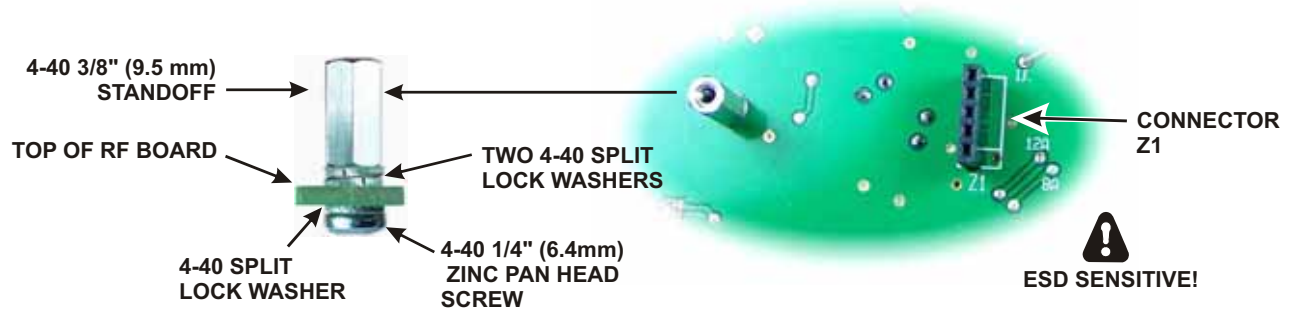


Figure 7. K3 Mixer Standoff Location.

☐ Install the two KBPF3 standoffs shown in Figure 8. Even if you didn't purchase the KBPF3 general coverage option, the standoffs and hardware are included in the K3 kit to make installing the option easier at some future date. Note that these standoffs have only *one* lock washer between each standoff and the RF board.

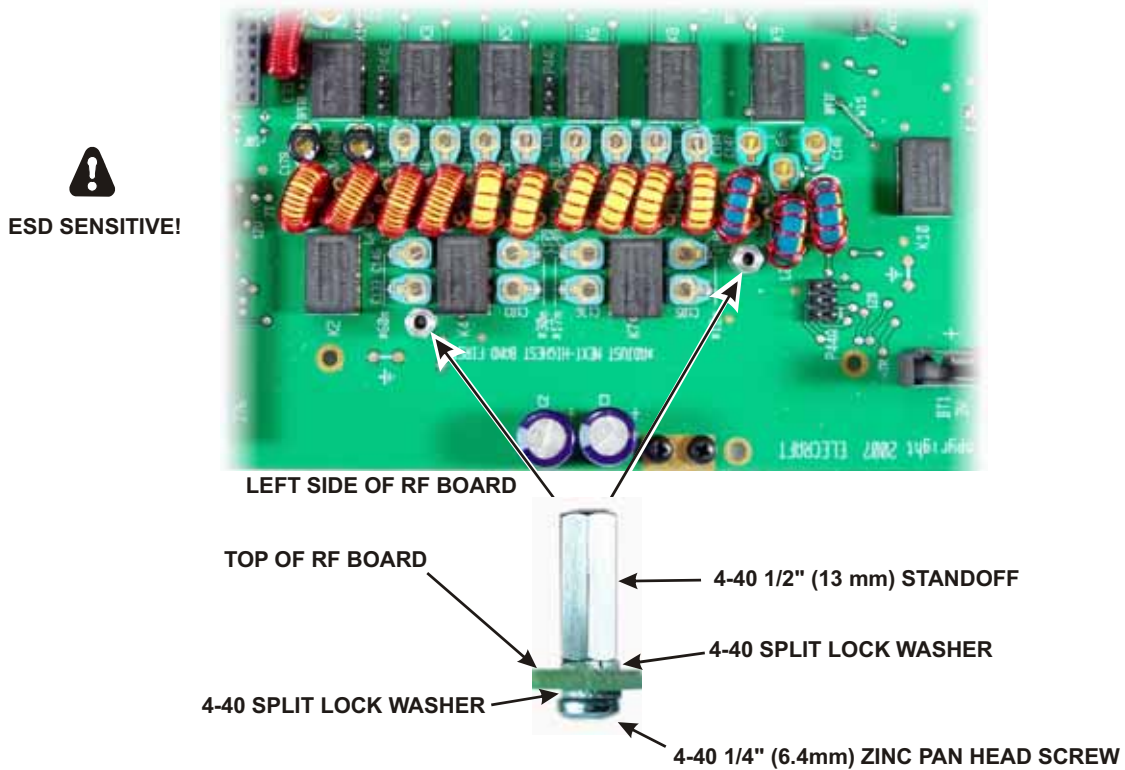


Figure 8. Installing KBPF3 Standoffs.

Install hardware to attach Q3 to the RF board near the rear left corner as shown in Figure 9 and Figure 11 on page 14.

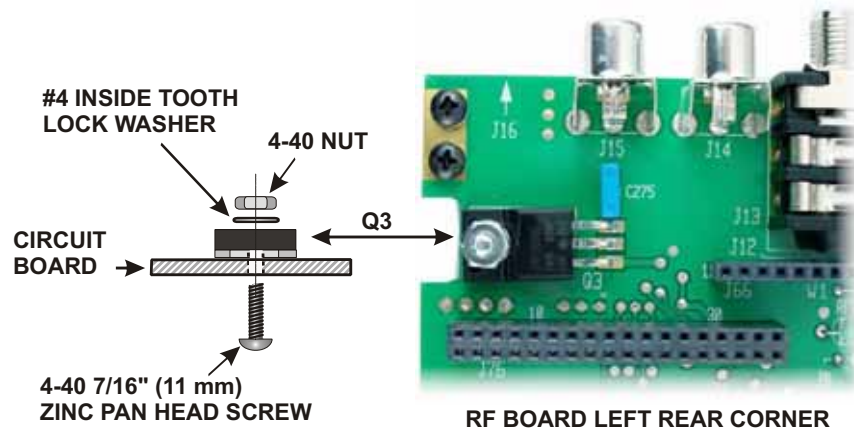


Figure 9. Installing Q3 Hardware on RF Board.

Locate the crystal I.F. filters. Two types of filters are available: standard 5-pole filters and optional 8-pole filters (see Figure 10). One standard 5-pole 2.7 kHz filter is supplied. If you have elected to equip your K3 with the optional 8-pole 2.8 kHz filter, it has been supplied instead of the 2.7 kHz filter. If you have purchased additional filters, they may be installed now as well. If you plan to add filters later, spaces may be left for them. For example, if you plan to add the FM or a 6 kHz AM filter later, you can leave spaces FL1 and FL2 open for them and install the 2.8 kHz filter in position FL3. The filters are not hard to move about later, so if you aren't sure, install the widest at FL1, the next widest at FL2 and so on.

**⚠ See Appendix A in your Owner's Manual for more information about making a filter plan and installing multiple filters and for installing filters for use with the sub-receiver.**

Enter the following data on Table 1. You will need this information to set up your filters after assembling your K3. Be sure you're following the rule described in the step above about the proper order for the filters.

- Enter the bandwidth in the row opposite the filter position where it will be installed.
- Enter the FREQ OFFSET shown on each filter. The optional 8-pole filters have no FREQ OFFSET marked on them. Enter a zero in the FREQ OFFSET column for those filters.

Table 1. Filters Installed.

POSITION	BANDWIDTH	FREQ OFFSET
FL1		
FL2		
FL3		
FL4		
FL5		

Install the filters as shown in Figure 10. Refer to the list of filters you created in Table 1 to determine which filter to install at each location.

**⚠ CAUTION**

1) Do not use screws longer than 1/4" (6.4 mm) to mount the filters. Use your ruler to measure the screws before installing them. Longer screws may extend into the optional 8-pole filter and destroy it. We strongly recommend you use a 1/4" screw even when installing the 5-pole filters to reduce the possibility of damaging an 8-pole filter should you change them later.

2) Do not over-tighten the screws. Too much torque may pull the threaded bushing out of the bottom of the filter module.

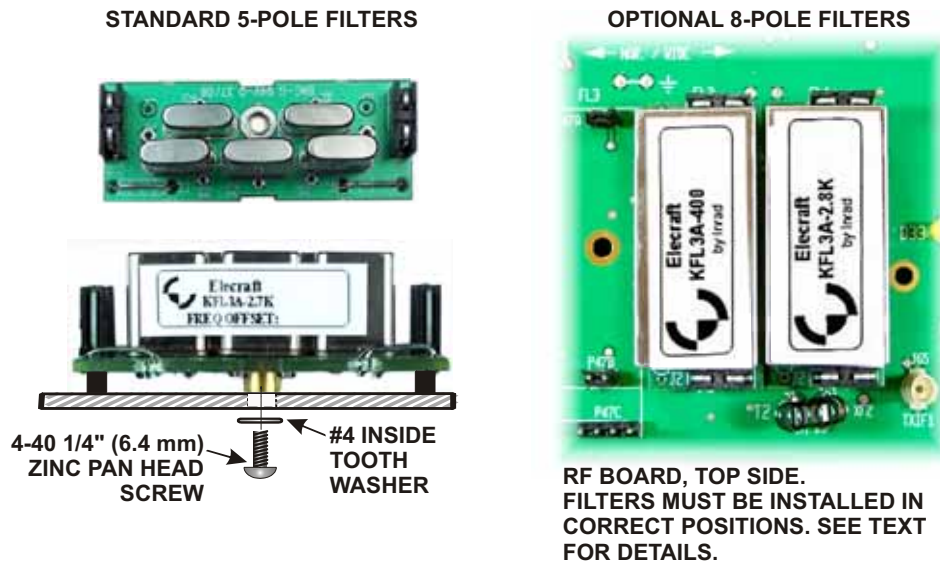


Figure 10. Installing Crystal I.F. Filters on RF Board.





**ESD SENSITIVE!**

**WEAR A GROUNDED  
WRIST STRAP OR TOUCH  
AN UNPAINTED METAL GROUND  
BEFORE HANDLING THE RF BOARD.**

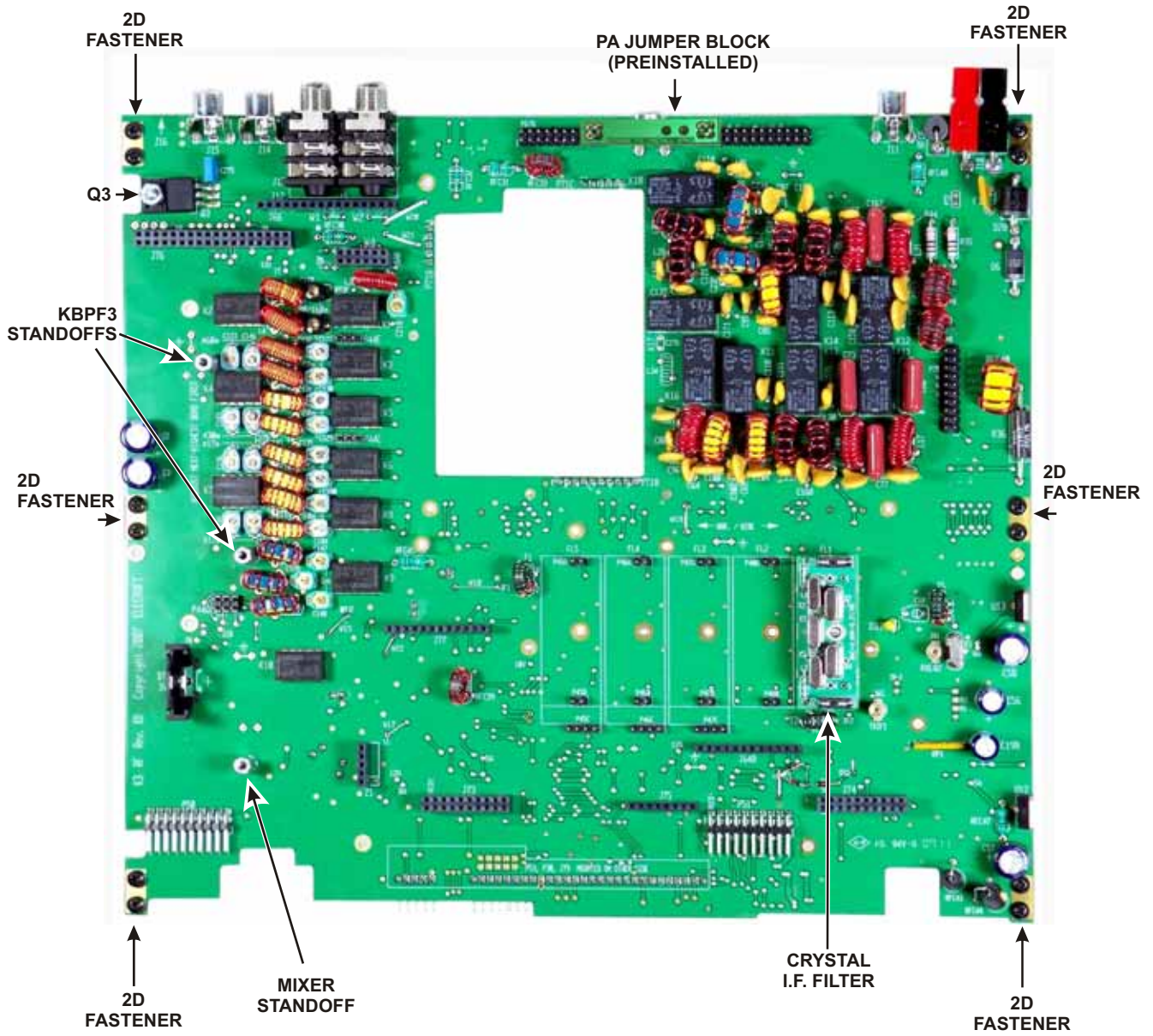


Figure 11. RF Board Partially Assembled.

□ Install the Low Power Amplifier (LPA) board in the cutout on the RF board as shown in Figure 12. The LPA board is held in place by its connectors until the bottom cover is installed..

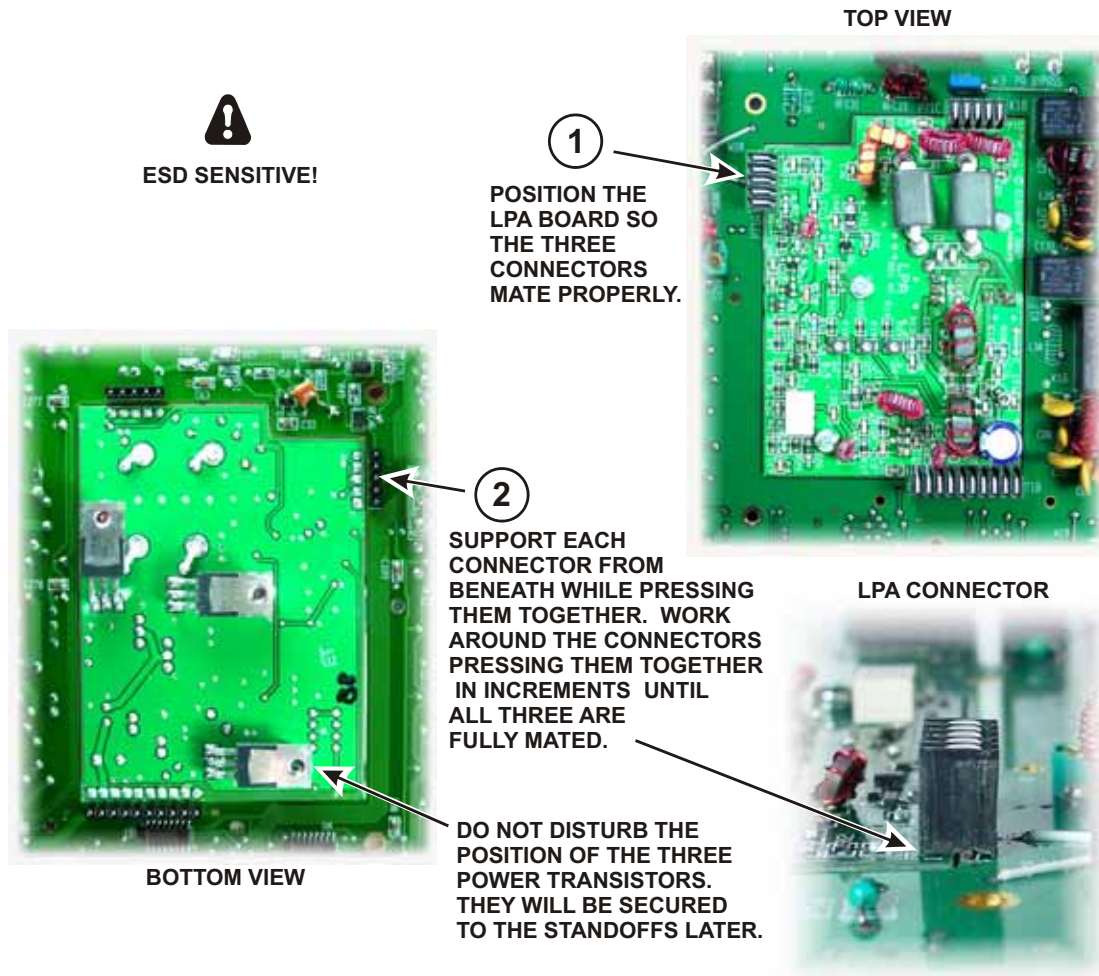


Figure 12. Installing the Low Power Amplifier (LPA).

□ Mount the front panel shield on the RF board as shown in Figure 13, then mount a 2D fastener on each ear at the top of the shield as shown. Be sure the 2D fasteners are oriented with the widest part between the two holes and the edge toward the outside as shown.

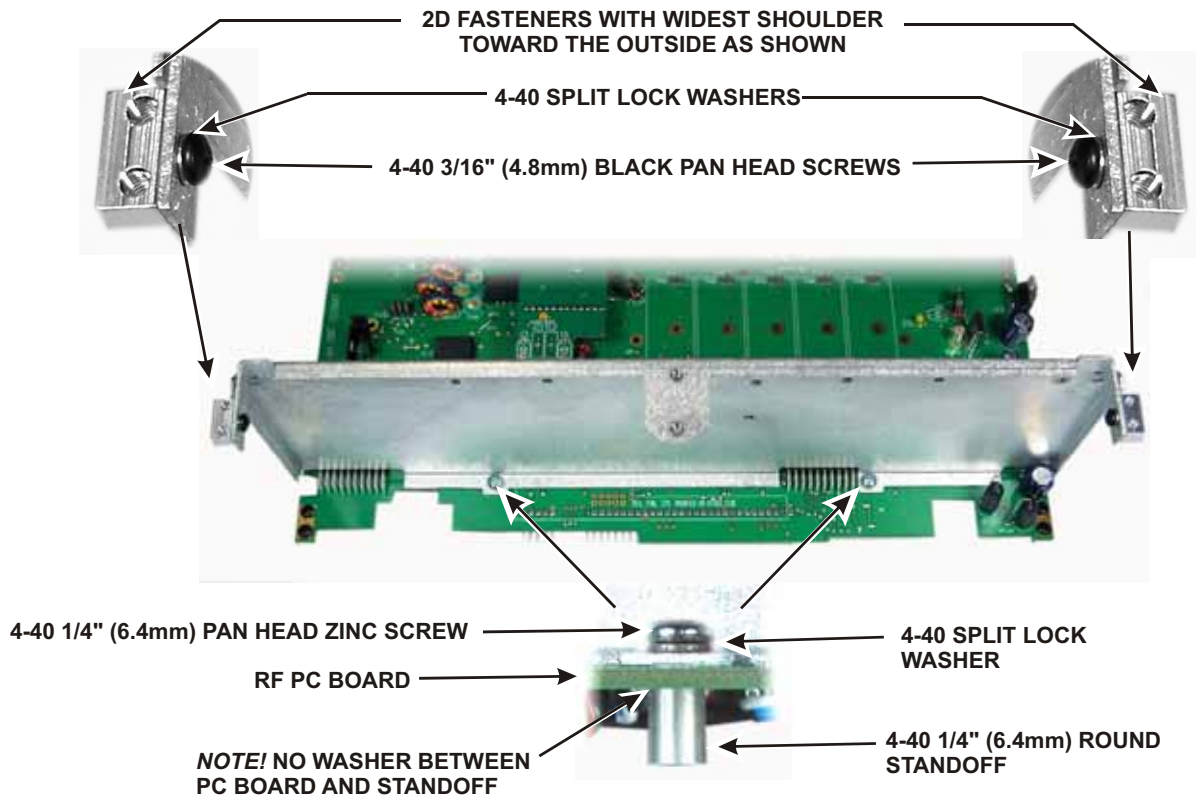


Figure 13. Installing Front Panel Shield.

□ Mount the K3 mixer board on the RF board as shown in Figure 14. The mixer plugs into Z1 on the RF board.

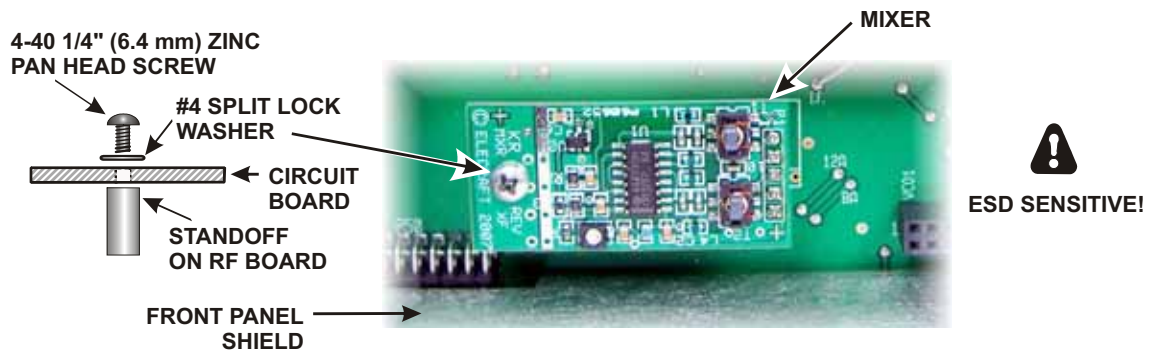


Figure 14. Installing K3 Mixer and KNB3 Noise Blanker Boards.

Locate the two side panels. They are approximately 4" (10 cm) by 9-7/8" (25 cm) in size. Both panels have six counter-sunk screw holes near the edges. Note that the countersunk holes are farther from one end than the other. This is important. You will need to orient the panels correctly as you install them. The side panels are different as well. In addition to the six counter-sunk screw holes, the left side panel has two holes near the centerline for attaching the handle. The left side panel with the handle attached is shown in Figure 16. The right side panel has six additional holes, four for mounting the side feet and two for attaching other parts inside the K3 (see Figure 19). Set the right side panel aside for now.

Check the inside (partially painted) of both panels to ensure no masking tape is covering any screw holes. If found, peel it off.

Attach the handle to the left side cover using the hardware shown in Figure 15 at each end. The ribbed side of the handle faces away from the panel. Tighten the screws enough to compress the lock washers, but do not tighten the screws so much that you deform the handle end cover. The handle should move easily to allow room for your fingers between the handle and cover for carrying, then lie flat against the cover when it is not in use.

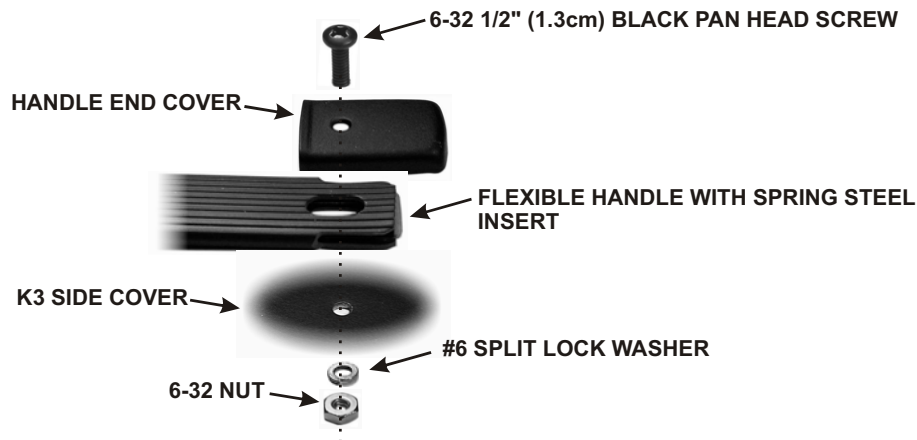


Figure 15. Installing Side Handle Mounting Hardware.

Attach the left side panel to the RF board assembly as shown in Figure 16 using five 4-40 3/16" (17mm) black flat head screws. Do **not** use washers. When the panel is oriented correctly, the edge of the panel will extend about 1/2" (13 mm) past the 2D fasteners at the front panel shield. If the threaded holes in the 2D fasteners don't line up properly with the holes in the side panels, temporarily loosen the screws attaching the 2D fastener to the RF board or front panel shield, then tighten them again after the side panel is installed.

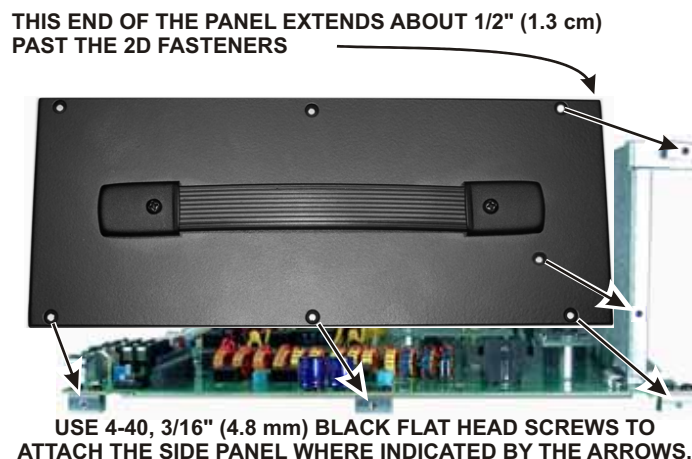


Figure 16. Mounting Left Side Panel.

Inspect the area where the side panel meets the front panel shield, and make sure there is positive mechanical contact at the screw just below the end of the handle and about 3/4" (19 mm) above the RF board. The area of the side panel around that point is clean metal. Tighten the screws as needed to ensure good contact at that point and at each 2D fastener.

**⚠ CAUTION**

**Failure to establish a solid contact at that point may result in birdies in the receiver. Throughout the assembly, be sure all chassis screws are tight!**

Mount a 2D fastener at the top back corner of the left side panel (the one you just installed) with a 4-40 3/16" (4.8 mm) black flat head screw as shown in Figure 17. Do *not* use washers. Be sure the 2D fastener is oriented correctly as shown in the figure.

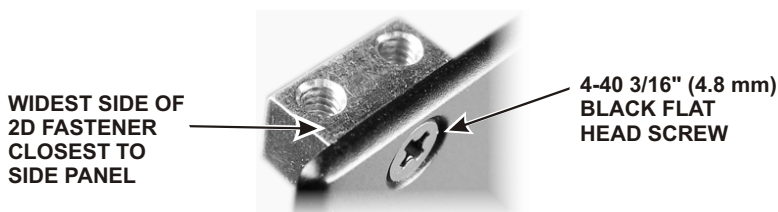


Figure 17. Installing Left Side Panel 2D Fastener.

## KANT3 or KAT3, Right Side and Rear Panels

**⚠ If you purchased a KAT3 with your kit, you did not get a KANT3 board with your kit. For more information, see the *KANT3 AND KAT3 Circuit Description* below.**

### *KANT3 or KAT3 Description*

The basic K3/10 includes a KANT3 antenna input module. If you've ordered a KAT3 antenna tuner, the KANT3 is not required and will not be supplied with the kit. In either case, the module plugs into the RF board at the back-right corner. Both the KANT3 and KAT3 provide antenna surge protection, as well as resistors for bleeding off static DC charge. The KAT3 provides a wide-range, switchable C-in/C-out L-network. See *Theory of Operation, KANT3 and KAT3*, in the K3 Owner's Manual for more details.

### *KANT3 or KAT3, Right Side and Rear Panel Installation Procedure*

Locate the rear panel and check the inside for any masking tape still covering screw holes. If found, peel it off.

Mount the SO239 connector in the ANT1 position on the rear panel using two 4-40 1/4" (6.4 mm) black pan head screws, two 4-40 inside tooth lock washers and two 4-40 nuts as shown in Figure 18. The flange of the SO239 connector is on the inside (unpainted) side of the rear panel.

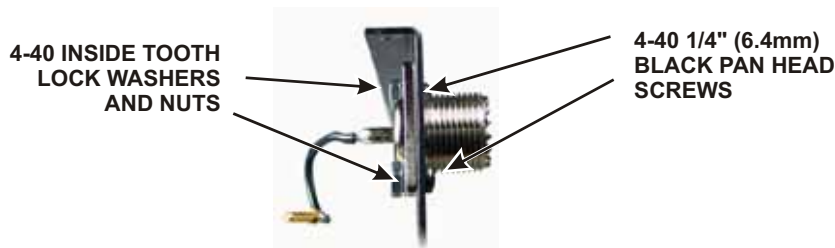


Figure 18. Mounting the ANT1 Connector.

If you are installing the KAT3, install the second SO239 connector in the ANT2 position on the rear panel using two 4-40 1/4" (6.4 mm) black pan head screws, two 4-40 inside tooth lock washers and two 4-40 nuts just as you did for the ANT1 connector. Set the rear panel aside for now.

Install the four rubber side feet in the holes in the right side panel as shown in Figure 19. Two suggested procedures for doing this are as follows:

**Press Method:**

- Wet the tip of the foot with a *tiny* amount of soap. (Do not use petroleum jelly or oils. They can deteriorate the rubber over time).
- Place the foot, tip up, on a solid work surface.
- Position the panel with the outside (fully painted side) toward the foot with the hole in the panel against the tip and press down. The tip should slip through the hole without further help. If necessary, grip the tip and pull with your long-nose pliers, working it from side to side until the shoulder opens against the inside of the panel. ***Do not use excessive force. You can tear the foot apart.***
- Wipe any excess soap off of the panel or foot.

**Twist Method:**

- Press the foot against the outside (fully painted side) of the panel so the tip is in the hole at an angle.
- While pressing the tip into the hole, twist the foot so the edge of the tip grabs the inside edge of the hole.
- Continue pressing and twisting until the tip is fully inside the panel all the way around its circumference. ***Do not twist with excessive force. You can tear the foot apart.***

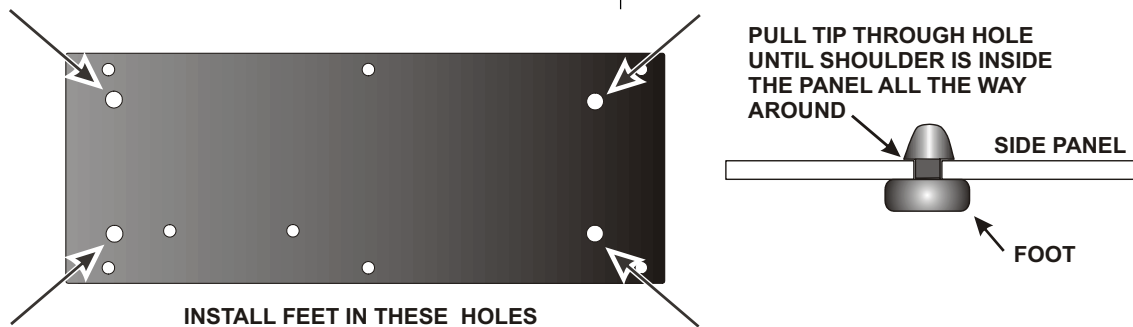


Figure 19. Installing Side Panel Feet.

Position the right side panel against the K3 to verify how it will fit against the RF board. When it is oriented correctly, the three holes along the bottom edge will line up with the holes in the 2D fasteners on the RF board and two holes in the side panel will be aligned with the tabs on voltage regulators U12 and U13. The end of the panel toward the rear will very nearly line up flush with the edge of the RF board. Do not mount the side panel yet, but note which corner of the panel is in the upper rear corner. You'll work with this corner in the next step.

□ At the upper rear corner of the side panel you just identified in the previous step, mount a 2D fastener as shown in Figure 20, using a black 4-40 1/2" (13 mm) flat head screw. Remember that flat head screws are measured from the flat top to the end of the threads. Note that the screw extends some distance through the 2D fastener.

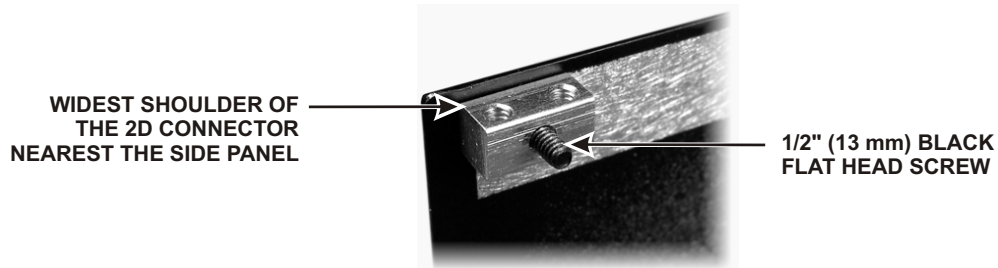


Figure 20. Mounting 2D fastener for KANT3 Standoff.

□ Screw a 4-40 1/2" (13 mm) standoff onto the exposed end of the screw as shown in Figure 21. **Do not use a lock washer between the standoff and the 2D fastener.** Tighten the standoff securely against the 2D fastener. Set the side panel aside temporarily.

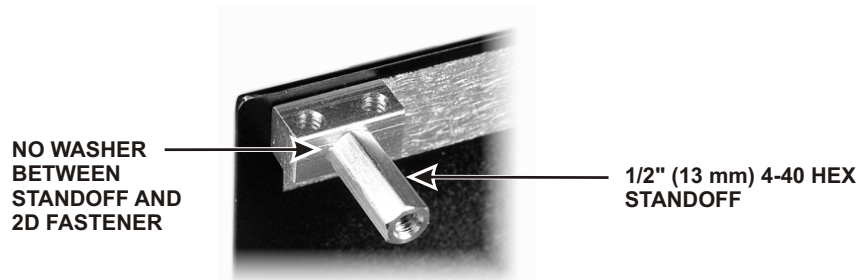


Figure 21. KANT3 Mounting Standoff.

□ Insert J70 on the KANT3 or the KAT3 board into P70 near the red and black APP power connectors at the right rear corner of the RF board. The KANT3 board is shown in Figure 22. The KAT3 board fits exactly the same way **with the toroidal inductors toward the center of the RF board.**

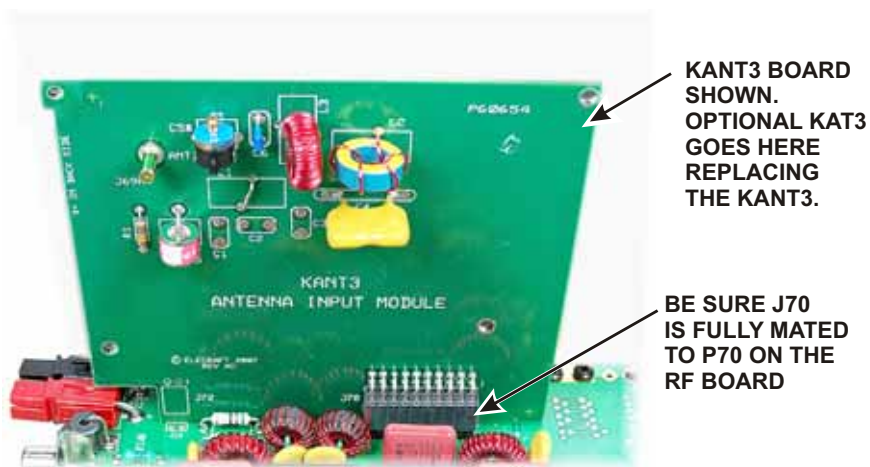


Figure 22. Installing the KANT3 or KAT3 Board.

□ Peel the backing from the self-adhesive serial number label and attach it to the back panel as shown in Figure 23. You may wait until the assembly is finished before attaching the serial number, but at this point you can lay the panel flat on the work surface to easily position the label square within the outline.

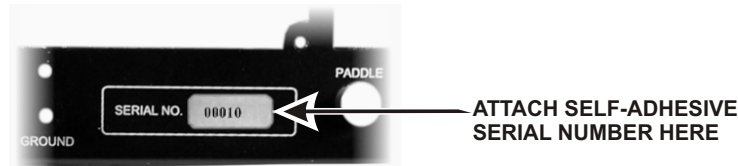


Figure 23. Attaching Serial Number.

□ Position the rear panel on the K3 chassis assembly so that the SO239 connector(s) are at the end nearest the KANT3 or KAT3 board. The hole above the GROUND legend on the rear panel should line up with the threaded ground stud on the RF board.

□ Thread the 6-32 thumbscrew into the ground terminal position near the center of the rear panel as shown in Figure 24. Use two #6 flat washers between the thumbscrew and the back panel as shown.

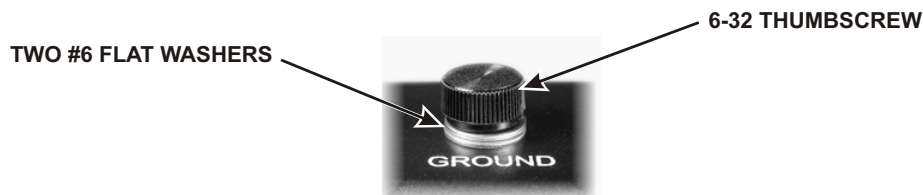


Figure 24. Installing Rear Panel Ground Screw.

□ Attach the bottom lip of the rear panel to the 2D fasteners at the rear corners of the RF board with 4-40, 3/16" (4.8 mm) black *pan head* screws. (Note that all the screws used on the bottom of the K3 are black pan head screws.)

□ Connect the wires from the SO239 connector(s) to the KANT3 or KAT3 board as shown in Figure 25. Use needle-nose pliers to grip the terminals on the wire ends and carefully insert the connectors *straight* into the holes in the board. They may be very difficult to insert unless they are perfectly aligned. While inserting the plugs, support the top of the board with your fingers to avoid putting stress on the connector at the bottom.

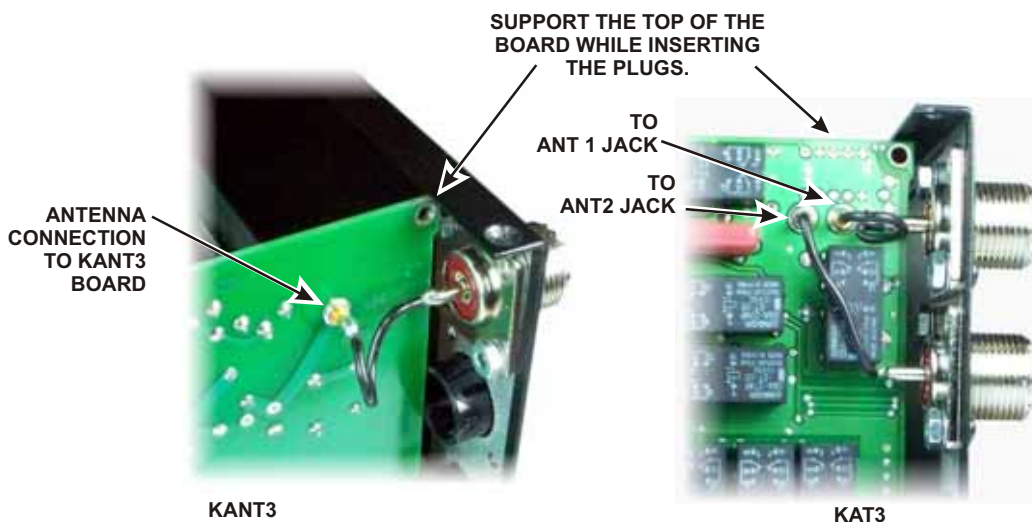


Figure 25. ANT Connections to KANT3 or KAT3 Boards.



Attach the right side panel to the RF board assembly four 4-40 3/16" (4.8mm) black flat head screws: three along the bottom and one at the top front into the 2D fastener on the front panel shield. Do **not** use washers. Note that there are two open holes for screws to secure voltage regulators U12 and U13. They will be installed later.

Mount the KANT3 or KAT3 board to the standoff on the side panel with a 4-40 1/4" (6.4mm) zinc pan head screw and a #4 inside tooth lock washer under the screw head as shown in Figure 26. **Do not place a washer between the board and the standoff.**

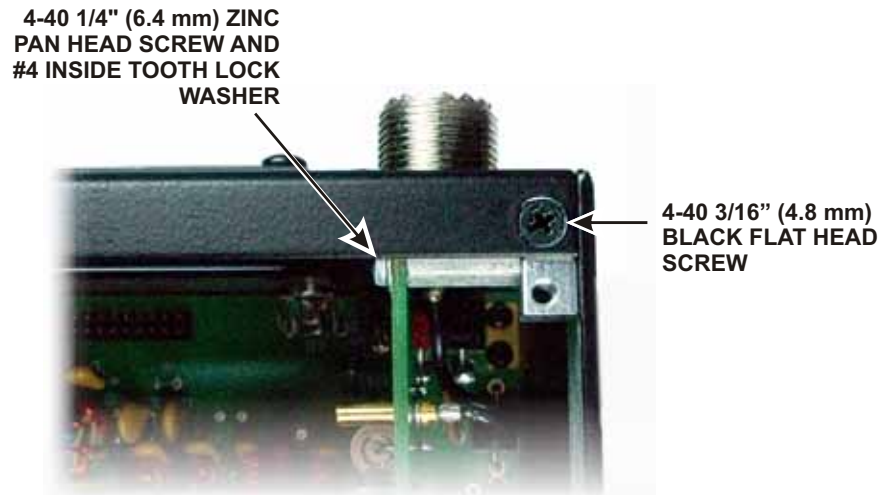


Figure 26. Installing KANT3/KAT3 Mounting Screw.

Install a 4-40 3/16" (4.8 mm) black flat head screw to secure the top of the rear panel to the 2D fastener as shown in Figure 26

Install another 4-40 3/16" (4.8 mm) black flat head screw at the opposite end of the rear panel to secure it to the top 2D fastener on the left side panel. When properly positioned, the rear panel should fit snugly against the inside edge of the side panel as shown in Figure 26. Verify the fit is correct at both ends. If necessary loosen the 2D fastener screws enough to adjust the position of the panels. .

If you installed the KANT3 board, the hole for the ANT2 jack is not used. Insert the larger of the hole plugs in the opening until it clicks in place (see Figure 27).

□ Insert the smaller hole plugs in the AUX RF connector hole at the bottom left and the REF connector at the bottom right. Align the open side of the plug with the flat side of the hole as shown in Figure 27. If the plug does not have a cutout, use your diagonal cutters to clip out a section of the plug so it will fit into the hole.

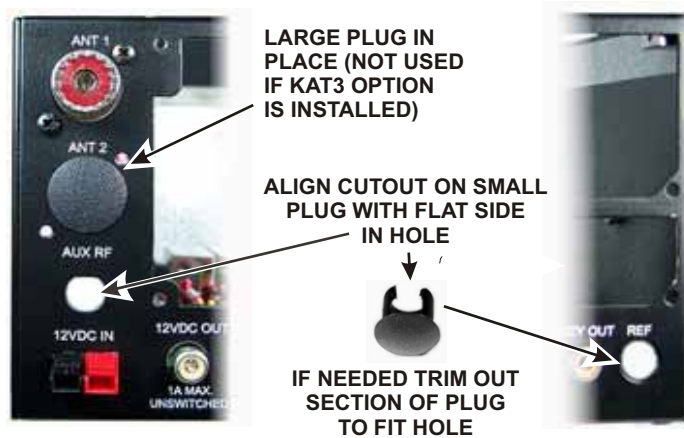


Figure 27. Installing Rear Panel Hole Plugs.

## KIO3 Interface

### *KIO3 Description*

All rear-panel audio and digital/computer I/O is routed through the KIO3. The KIO3 is made up of three PC boards: Main, Audio I/O and Digital I/O. The Main KIO3 board plugs directly into the RF board, while the Audio and Digital I/O modules plug into the KIO3 main board. All three boards can be upgraded to meet future requirements. See *Theory of Operation, KIO3*, in the K3 Owner's Manual for more information.

### *KIO3 Interface Installation Procedure*

□ If you have purchased the KXV3 option with your kit, go to the *Installation Procedure* in the KXV3 manual and install the option now, following the instructions in the *Special Note to K3 Kit Builders*. Otherwise mount the small blank panel in the space directly above PADDLE, KEY, PTT and KEY OUT connectors on the rear panel as shown in Figure 28.



**DO NOT INSTALL IF YOU ARE INSTALLING THE KXV3 INTERFACE OPTION. SEE TEXT FOR DETAILS.**

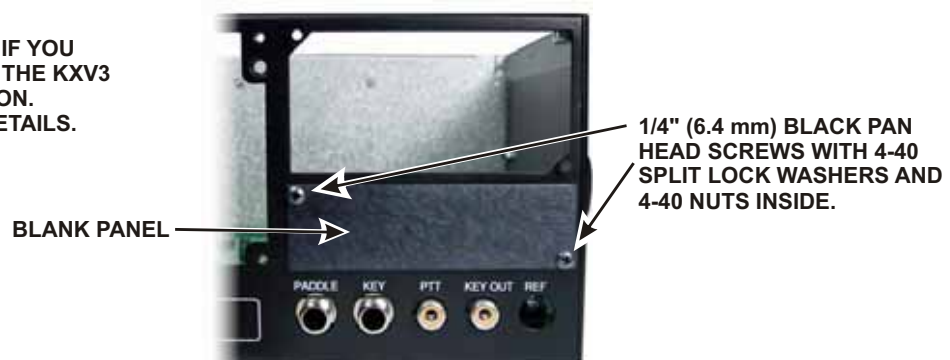


Figure 28. Preparing Rear Panel for KIO3 Installation.

□ Mount two 1-1/4" (31.8 mm) standoffs in the two holes on the KIO3 board as shown in Figure 29. One is in the corner and the other is about half way down the opposite side of the board. **Do not put lock washers between the standoffs and the board.**

□ Plug the Audio I/O daughter board into J91 as shown in Figure 29. The second daughter board will be installed later.

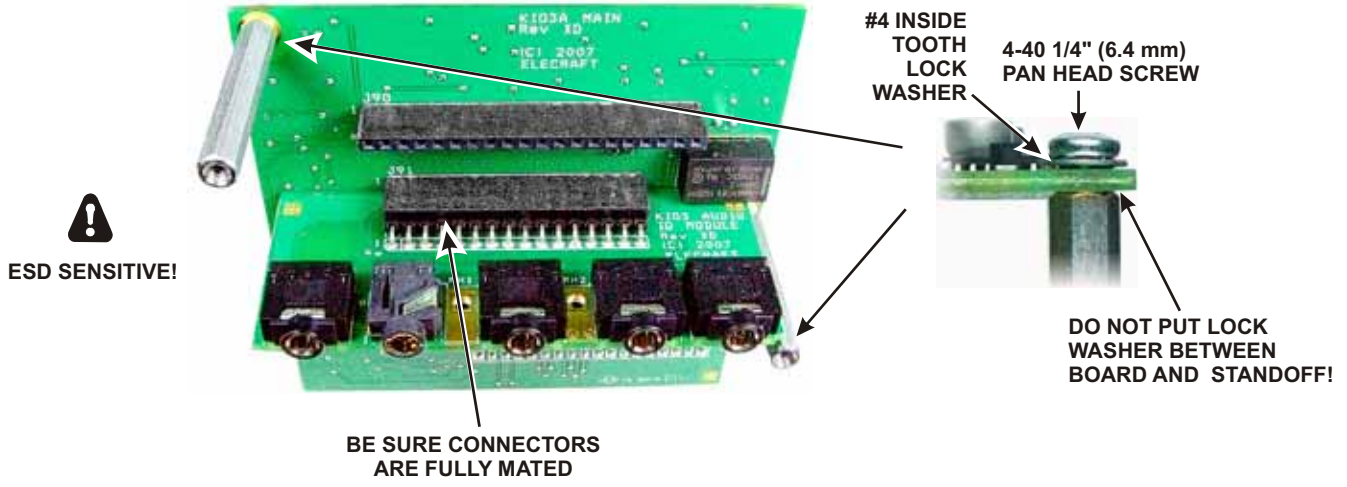


Figure 29. Preparing the KIO3 Board for Installation.

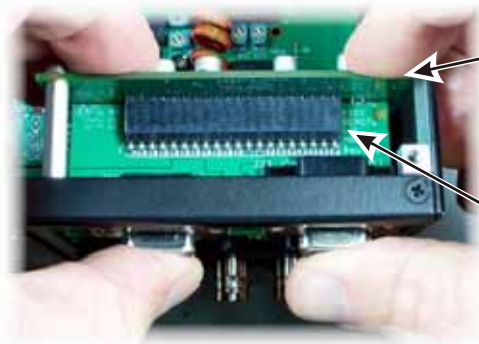
□ Install the KIO3 Main board with the Audio I/O daughter board attached into the K3 as shown in Figure 30. The KIO3A main board plugs into J76 on the RF board. If the KXV3 is installed, the coaxial TMP cable fits between the KXV3 and KIO3 boards. Ensure the connectors are fully mated so the standoffs line up with the screw holes on the rear panel.



Figure 30. Installing KIO3 Main Board.

- The DB9 multi-pin connector on the KIO3 Digital I/O daughter board may have jackscrew nuts installed on the connector. (Jackscrew nuts are shown in Figure 32). If so, remove them. They will be reinstalled shortly.
- Install the KIO3 Digital I/O daughter board as shown in Figure 31. Be careful to support the KIO3 main board as shown while pressing the daughter board in place.

  
ESD SENSITIVE!



SUPPORT THE KIO3 MAIN BOARD WHILE PRESSING THE DIGITAL I/O BOARD IN PLACE.

BE SURE THE PINS ARE PROPERLY ALIGNED AND THE CONNECTORS ARE FULLY MATED

Figure 31. Installing the KIO3 Digital I/O Board.

- Install the KIO3 rear panel as shown in Figure 32.

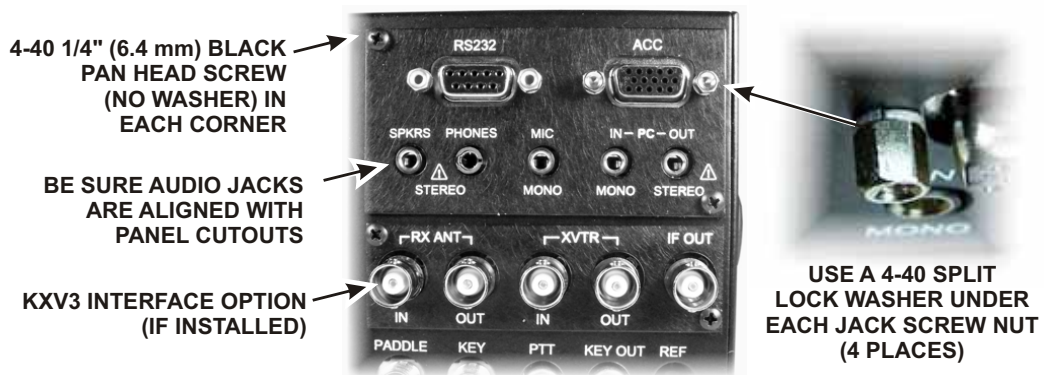


Figure 32. Mounting KIO3 Connector Panel.

## Front Panel and DSP

### *Front Panel and DSP Description*

The Front Panel is a large plug-in module that provides the K3's user interface (LCD, switches, shaft encoders, potentiometers, and LEDs) as well as the microcontroller (MCU) and parameter storage (EEPROM and FLASH). It also includes the 32-bit DSP assembly, which processes all AF and IF signals. See *Theory of Operation, Front Panel and DSP*, in the K3 Owner's Manual.

### *Front Panel Assembly Procedure*

#### **CAUTION**

**Do not use inside tooth lock washers where split lock washers are specified. Inside tooth lock washers are slightly larger and may short nearby circuit pads.**

- Mount three standoffs on the back of the front panel board as shown in Figure 33 . Place the lock washer between the screw head and the board as shown.

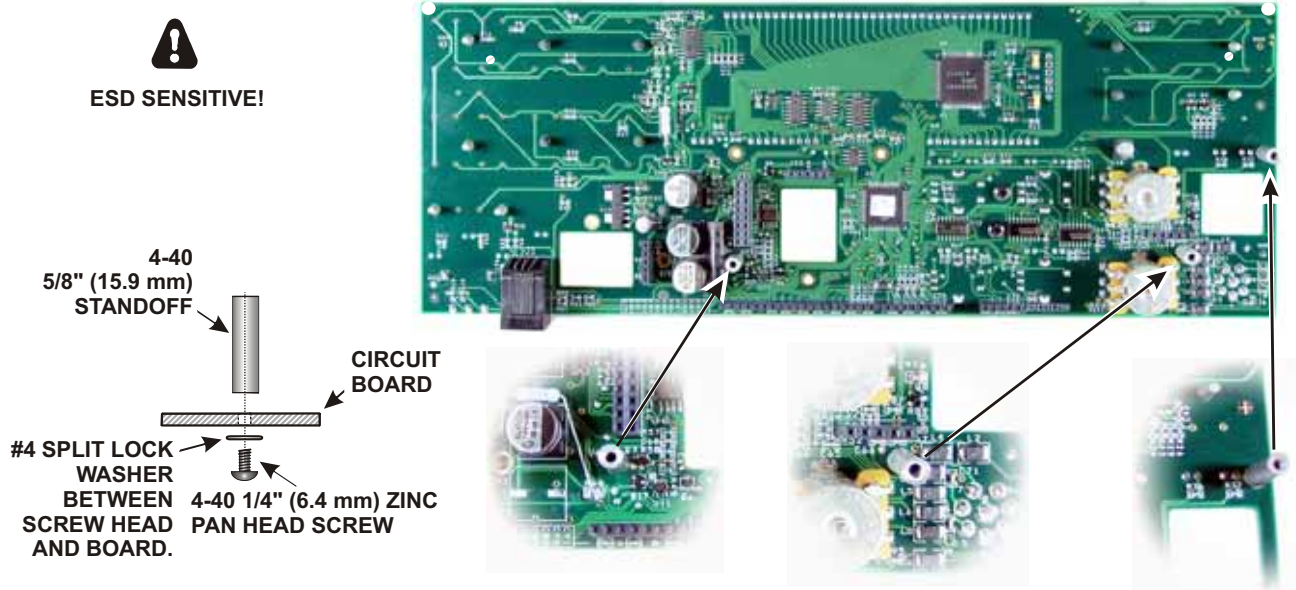


Figure 33. Preparing the Front Panel Board for Mounting, Part 1.

- On the front side of the board, mount four standoffs as shown in Figure 34.

**⚠ IMPORTANT!**

1. Place the split lock washers between the standoff and board as shown in the figure. This is important to establish the correct spacing between the board and the front panel.
2. Note that the two standoffs near the LCD use smaller #2 hardware.

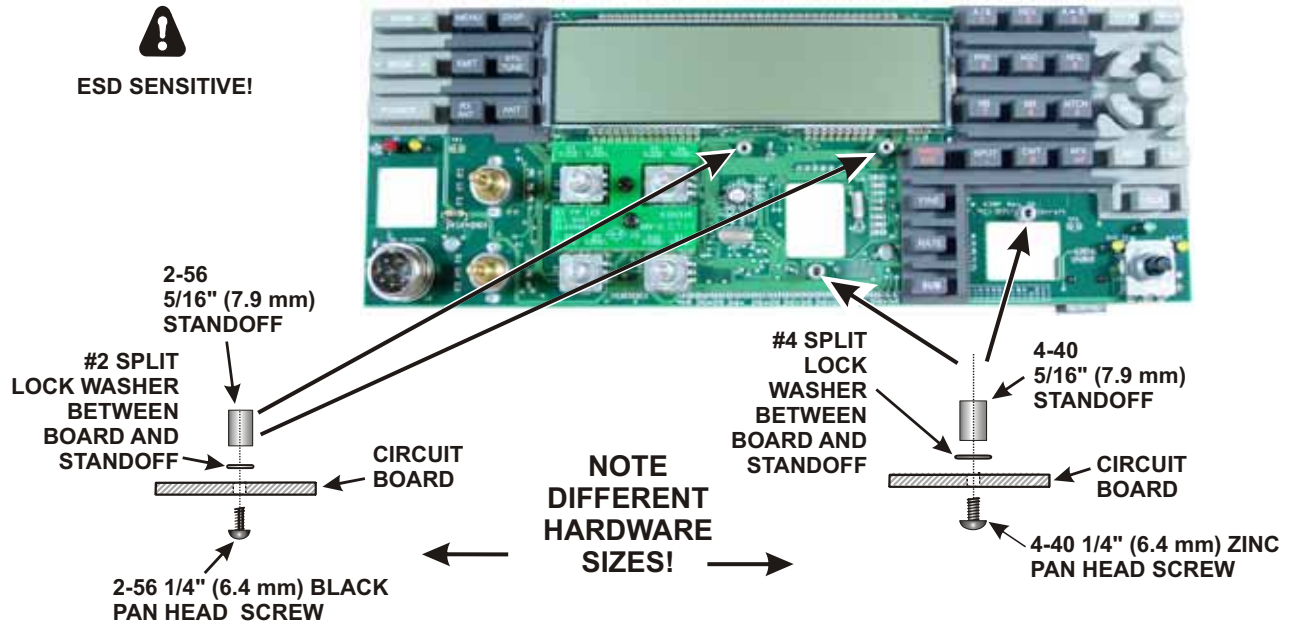


Figure 34. Preparing the Front Panel Board for Mounting, Part 2.

- Inspect the front panel board to verify the following:
  - Three 4-40 5/8" (15.9 mm) standoffs are mounted on the back as shown in Figure 33.
  - Two 4-40 5/16" (7.9 mm) standoffs are mounted on the front as shown in Figure 34.
  - Two 2-56 5/16" (7.9 mm) standoffs are mounted on the front as shown in Figure 34.

☐ Install the two soft foam light blockers at the ends of the LCD display as shown in Figure 35. Remove the paper strip covering the adhesive on each blocker and stick that side against the board (or the lip at the base of the switch buttons) so it stands up between the switches and the LCD. Cover the terminals at the right hand end of the LCD as shown. The blockers should be nearly flush with the front edge of the LCD to block the excess light that leaks out of each end of the display.

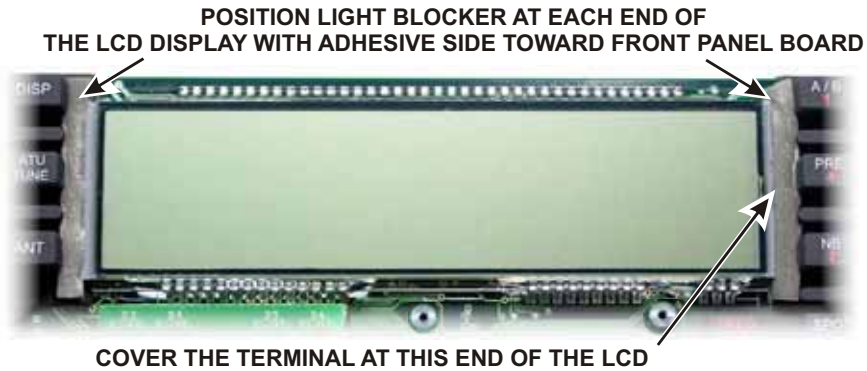


Figure 35. Installing LCD Light Blocker.

☐ Use your Digital Multimeter (DMM) to measure the resistance between the hardware and circuit points shown in Figure 36 to ensure the hardware is not causing a short. If either reading is lower than shown, loosen the hardware and adjust its position as needed..

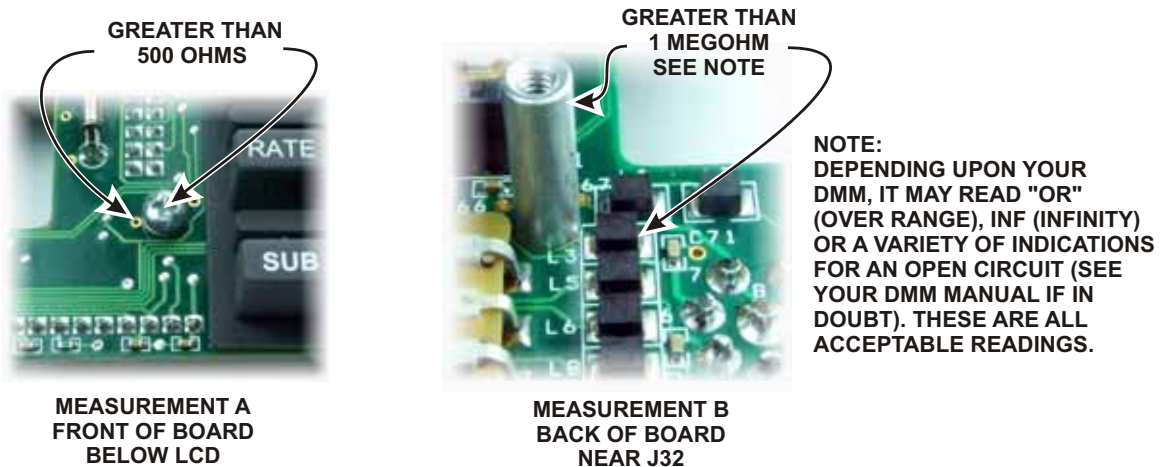


Figure 36. Front Panel Board Resistance Measurements.

☐ Locate the front panel and inspect the inside surface for any masking tape covering the holes left during the painting process. If any is found peel it off.

Place the front panel board face up on your work surface, then set the front panel over it as shown in Figure 37. Check the following:

- The MIC connector is in the hole and its flange is not caught behind the panel. The flange should stand even or slightly above the panel as shown. It may be a snug fit requiring you to press it gently into place. If the MIC connector refuses to fit through the hole in the front panel, use a sharp tool to carefully remove the paint from the inside edge where the connector is binding against the hole. Work from the *inside* of the front panel to avoid damaging the paint on the front edge of the MIC connector hole.
- The LEDs above the four controls under the LCD display and above the control in the lower right corner of the panel are positioned in their openings. If necessary, gently adjust the position of the LEDs.

Secure the front panel to the board with a 4-40 3/16" (4.8 mm) black flat head screw above the control opening near the right end and a 3/8" (9.5mm) nut and inside tooth lock washer on each concentric pot bushing near the left end as shown. Tighten the screw and nuts only until you feel firm resistance. Be very careful not to scratch the front panel.



Figure 37. Mounting the Front Panel on the Front Panel Board.

Two identical encoder assemblies are provided for VFO A and VFO B. Select one encoder and place a 3/8" (9.5 mm) inside-tooth lock washer over the threaded shaft as shown in Figure 38. This will be the VFO A encoder.



Figure 38. VFO A Encoder Assembly Preparation for Installation.



Place the VFO A encoder in the opening near the center of the front panel board so the shaft protrudes through the opening under the LCD. Be careful to avoid dropping the lock washer into to the space between the front panel board and the front panel. Normally, the lock washer hangs on the threads while you put the encoder in place. Optionally, you can hold the encoder with the shaft upright and place the front-panel assembly over it until the shaft is through the hole. Orient the encoder so the pins mate with connector J33 on the front panel board as shown in Figure 39.

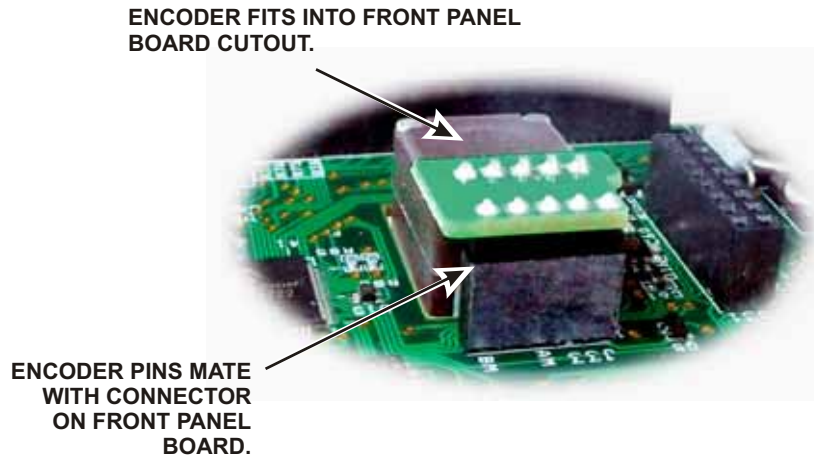


Figure 39. Mounting VFO Encoders.

Place a 3/8" (9.5 mm) inside tooth lock washer and nut on the threaded shaft of the VFO A encoder and tighten them against the front panel. Take care not to damage the front panel paint with your tools.

Place a 3/8" (9.5 mm) nut on the threaded shaft of the remaining encoder and screw it up against the shoulder on the encoder bushing as shown in Figure 40.



Figure 40. VFO B Encoder Assembly Preparation for Installation.

Place the VFO B encoder in the opening near the end of the front panel board so the nut rests against the inside of the front panel and the encoder pins mate with J34. The connectors may not mate fully, leaving a very small area of the pins showing. That is normal.

Place a 3/8" (9.5 mm) inside tooth lock washer and nut on the threaded shaft of the VFO B encoder and tighten them against the front panel. Take care not to damage the front panel paint with your tools.

Place a second 3/8" (9.5 mm) nut on the VFO A encoder shaft under the LCD and tighten it against the nut you installed earlier (see Figure 41).

Locate the clear plastic LCD display cover and VFO A trim panel. They may have an adhesive paper covering them for protection. If so remove it. If needed, wash the them in warm water with mild soap. To avoid etching or scratching the surface, do not use harsh detergents or wipe them with paper towels.

## **⚠ CAUTION!**

In the following steps you will attach the plastic LCD cover and VFO A trim panels to the front cover using small screws. Do not over-tighten these screws. Tighten the screws only to the point where you feel some resistance. It is very easy to strip the threads, especially the screws holding the LCD cover. If you strip these threads the only remedy is to obtain a new front panel!

- Brush or blow any dust or lint away from the front panel area around the encoder shaft under the LCD, then mount the trim panel as shown in Figure 41, oriented so the beveled edges are away from the front panel. Tighten the screws only until they come into firm contact with the trim panel. **Be careful not to over-tighten the screws or you may strip the threads or break the trim panel!**



Figure 41. Mounting VFO A Trim Panel.

- Ensure the LCD cover is free of dust, smudges and fingerprints. Check the screw holes to be sure they are clear of any bits of plastic that might be dislodged during installation.

- Mount the cover over the LCD as shown in Figure 42 oriented so the beveled edges are away from the panel. Tighten the screws only until they come into firm contact with the trim panel. **Be careful not to over-tighten the screws or you may strip the threads in the front panel or break the LCD cover. These threaded holes in the front panel are easy to strip!**

**⚠ DO NOT OVER-TIGHTEN THE SCREWS! DOING SO MAY STRIP THE THREADS AND RUIN THE FRONT PANEL OR BREAK THE LCD COVER.**



Figure 42. Installing LCD Cover.

- Place the larger of a pair of concentric knobs over the RF/SQL - SUB control as follows (See Figure 43):

**⚠ CAUTION!**

**Do not over-tighten the set screws in the knobs in the following steps or you may crack the knobs! Use only enough torque to hold the knobs in place.**

- Turn both shafts fully clockwise
- Place the larger knob over the shafts. Do not tighten the set screw yet.
- Place the smaller knob over the shaft, align its index line as shown in Figure 43 and tighten one set screw with a 0.050" Allen wrench.
- Rotate the larger knob so its index line is aligned with the index mark in the smaller knob, then lift it gently so it does not bind against the control bushing or the upper knob and tighten one set screw.
- Rotate both knobs about half way counter-clockwise and tighten the second set screw in each knob.
- Rotate the smaller and larger knobs over their entire range to see if moving one knob moves the other at any point in the rotation. If it does, loosen the set screws on the larger knob and move it slightly toward the panel until the knobs operate independently over their entire range of movement.

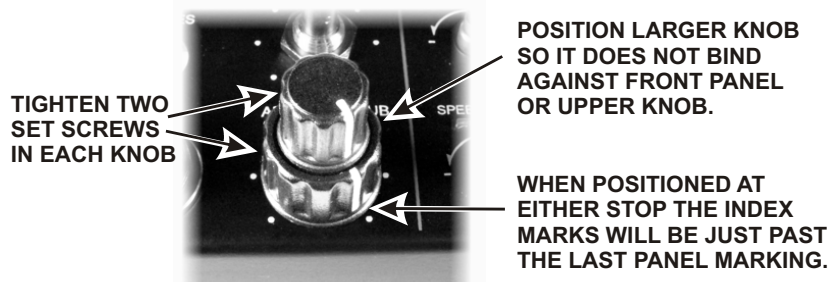


Figure 43. Mounting Concentric Knobs.

- Place a pair of concentric knobs over the AF-SUB controls in the same manner as you installed the RF/SQL-SUB knobs. Don't forget to start by turning both shafts fully clockwise.

□ Press small knobs on the four controls under the left end of the LCD: SHIFT/LOW, HI/WIDTH, SPEED/MIC and CMP/PWR. These knobs are all the same size. The four controls are encoders that rotate continuously, so the knobs have no index marks. The knobs are held in place by a friction spring as shown in Figure 44. Align the flat in the knob with the flat on each shaft before pressing each knob in place. In addition to the rotating encoder, each knob has a switch that is actuated by pressing the knob toward the panel. You will feel the switch action when you press each knob onto the shaft.

**⚠ If a knob feels very loose, check to see if the metal friction spring insert is in place as shown below. If not it should be in the bag with the knobs. Slide the spring insert into the knob and place it on the shaft. Friction will hold it and the knob securely once it is mounted.**

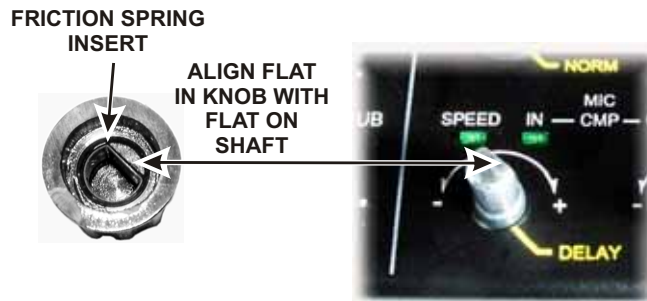


Figure 44. Mounting Friction Knobs.

□ In the same manner, mount the slightly larger friction knob onto the RIT/XIT control in the lower right corner of the front panel. The RIT/XIT control does not have the switch action of the other four encoders.

□ Mount the large knob on the VFO A encoder shaft below the LCD as shown in Figure 45. Before adding the finger grip, adjust the position of the knob against the felt washer to produce the desired amount of drag for smooth movement without the knob turning too freely.



Figure 45. Mounting the VFO A Tuning Knob.

□ Mount the last knob on the VFO B encoder shaft to the right (under the pushbutton switches) as shown in Figure 46. Before tightening both set screws, adjust the position of the knob against the felt washer to produce the desired amount of drag for smooth movement without the knob turning too freely.

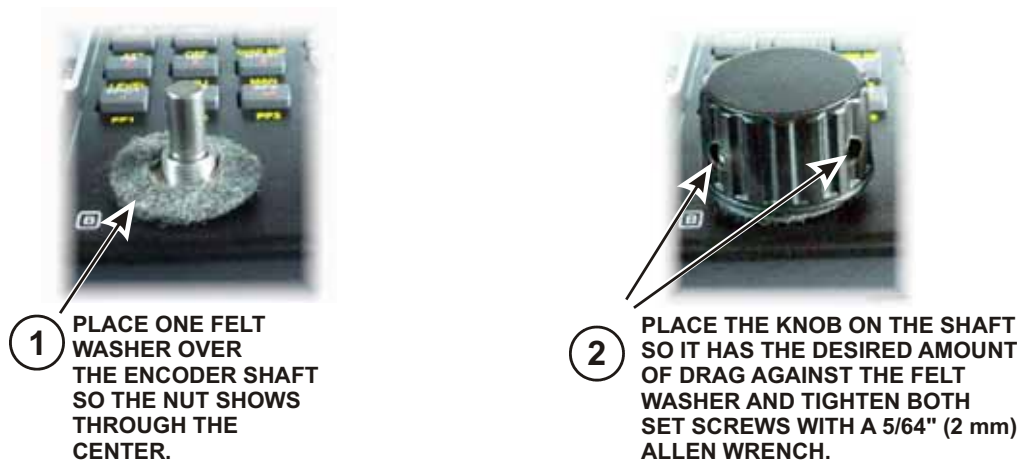


Figure 46. Mounting the VFO B Knob.

□ Mount the DSP board on the front panel board as follows. When you are done, the front panel assembly will look like Figure 47.

**⚠ ESD SENSITIVE: Wear a grounded wrist strap or touch an unpainted metal ground before touching the DSP or front panel boards.**

- Place the front panel assembly face down on a soft, clean surface to protect the finish. The back side of the front panel board should be facing upward.
- Position the large flat washer on the inside of the front panel over the PHONES jack hole (see Figure 48 on page 35). This is easily done by sliding the washer into place from the end of the front panel.
- Gently position the DSP board on the front panel board so that the large jack fits through the cutout in the front panel board with the threaded section passing through the large flat washer and the circular opening in the front panel. Adjust the position of the board as needed so you can see the standoffs on the front panel board lined up with the screw holes in the DSP board.
- Pick up the assembly while holding the DSP board in place and inspect the position of the two male plugs on the DSP board. They should mate with J31 and J32 on the front panel board. J31 is near the encoder for VFO A and J32 is between the two dual potentiometers. Adjust the DSP board's position as needed so the pins enter the corresponding holes in the sockets on the front panel board.
- Squeeze the boards together while ensuring the pins are mating with the connectors until the DSP board is resting against the three standoffs on the back of the front panel board that you installed earlier. The two connectors will not mate completely. About 1/4" (6.4mm) of the pins may be visible when the DSP board is positioned against the standoffs. There are other connectors on the DSP board as well, but the two that mate with J31 and J32 are the only ones that connect between the front panel and DSP boards.

- Secure the DSP board to the front panel board with three 4-40 1/4" (6.2 mm) zinc pan head screws and split lock washers as shown in Figure 47.

  
ESD SENSITIVE!

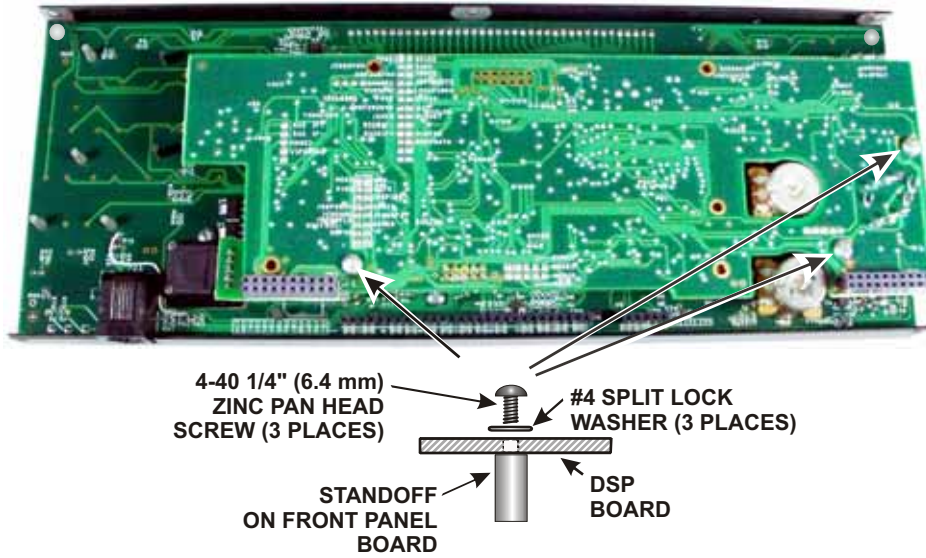


Figure 47. Mounting the DSP Board.

- Screw the knurled nut onto the threaded shaft of the PHONES jack where it exits the front panel (see Figure 48). Screw it only finger tight. Do not use pliers.

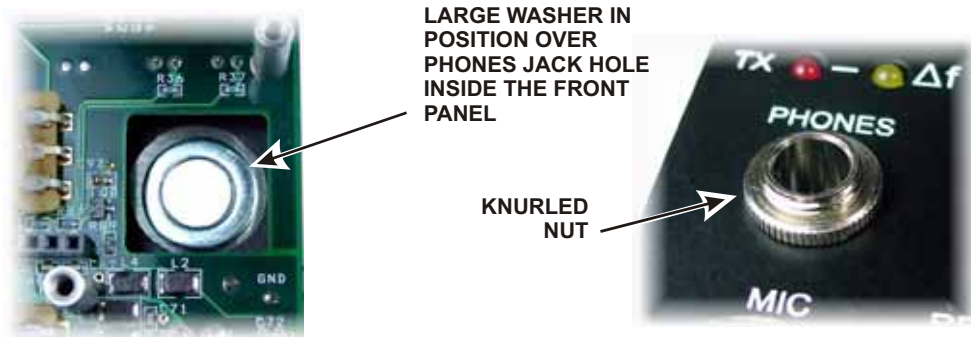


Figure 48. Phones Jack Hardware.

Remove both side panels from the chassis as follows. This will allow you to see the connectors that must mate properly when attaching the front panel assembly.

- Remove the two screws shown in Figure 49 so the 2D connector and standoff remain attached to the side panel. Remove the remaining screws in the right side panel to free it.
- Remove all of the screws in the left side panel (except the two screws holding the handle assembly) to free it.

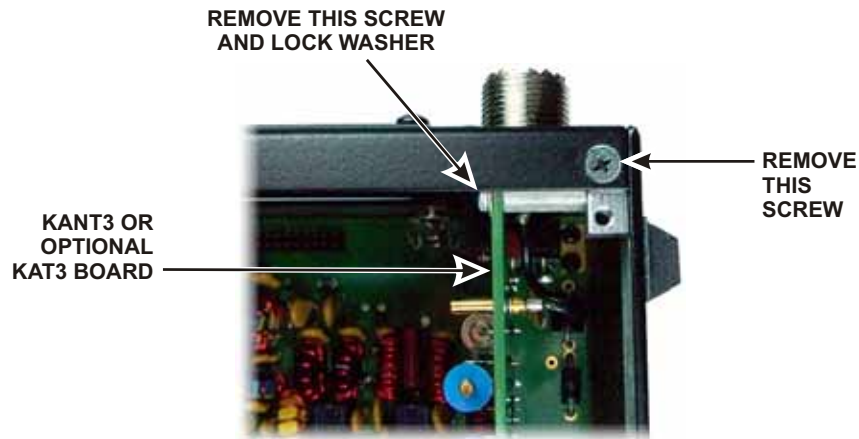


Figure 49. Removing Right Side Panel Hardware.

**⚠ ESD SENSITIVE: Wear a grounded wrist strap or touch an unpainted metal ground before handling the RF Board in the following steps.**

Turn the chassis upside down and position the front panel so the pins of P30 and P35 on the bottom of the RF board just begin to engage the connectors on the lower edge of the front panel assembly. Do not fully mate them yet.

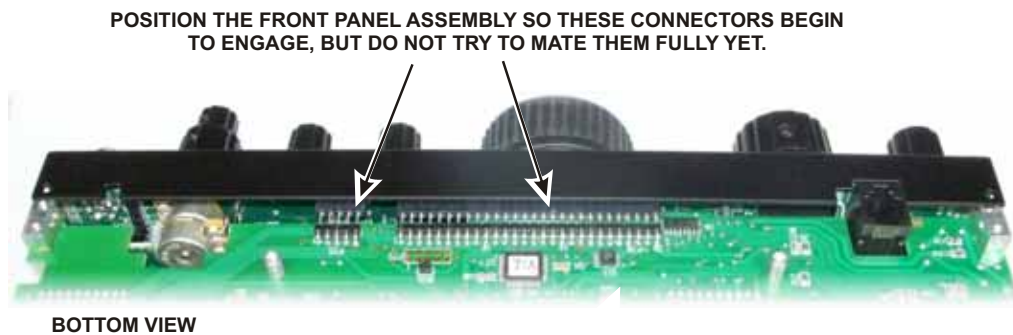


Figure 50. Mounting Front Panel Assembly - Connectors P30 and P35.

☐ Look at the two multi-pin connectors on the top of the RF board to see if they are engaging the corresponding connectors on the front panel assembly (see Figure 51). Adjust the position of the RF board or the front panel assembly to ensure they are mating properly.

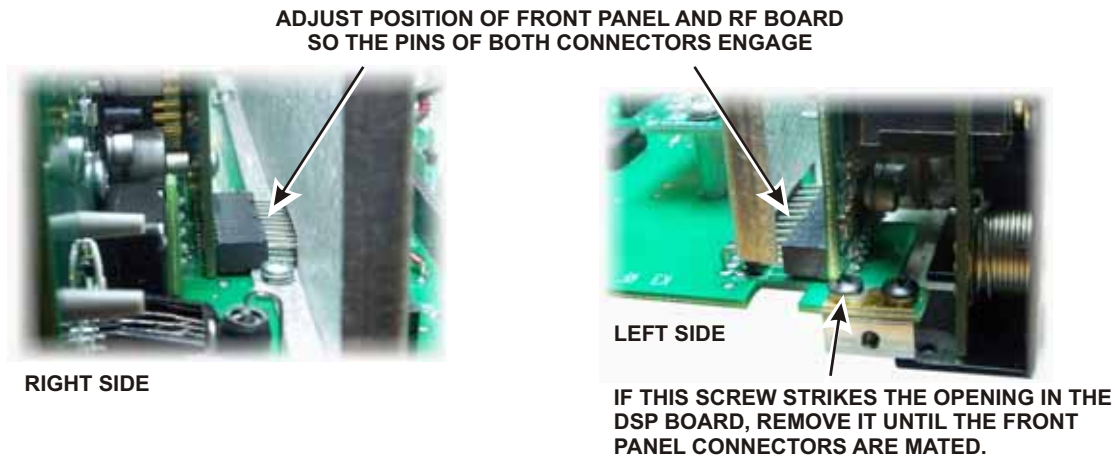


Figure 51. Mounting Front Panel Assembly - Connectors P50 and P51.

☐ With the pins of all four connectors started, press the front panel onto the RF board connectors. Press only from the bottom of the front panel to avoid flexing the RF board. You can use your fingers to press on the back side of each multi-pin connector on the top of the RF board while holding the front panel to engage them. There may be small areas of pins showing even after they are mated. You will know they are properly mated when the screw holes on the bottom lip of the front panel assembly line up with the screw holes in the 2D fasteners on the bottom of the RF board.

**⚠ REMOVING THE FRONT PANEL:** If you need to remove the front panel assembly, remove the five screws holding it to the chassis (three on the top lip and two on the bottom), turn the unit upside down and use a screwdriver in the two pry slots provided as shown in Figure 52. Do not insert the screwdriver deep enough to strike components on the boards! Pry each end in short increments until the connectors separate. Either a blade (as shown) or Phillips screwdriver may be used. Note that you may need to remove the left side panel and the 2D mounting screw shown in Figure 51.

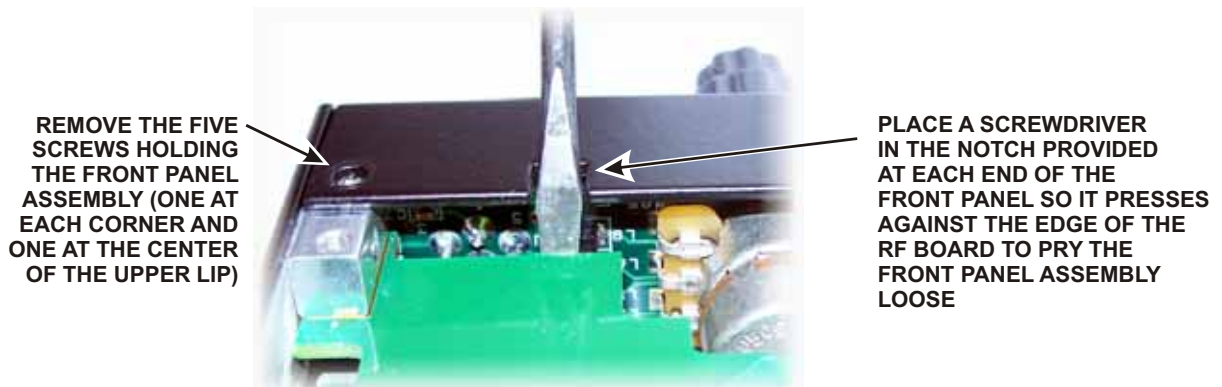


Figure 52. Removing the Front Panel.



Secure the front panel assembly at the bottom lip to the 2D fasteners at the forward edge of the RF board with two 4-40 3/16" (4.8 mm) black pan head screws.

If you removed the screw from the 2D fastener as shown in Figure 51, replace it and the lock washer.

Replace the right side panel (the panel with the feet) as follows:

- Start four 4-40 3/16" (4.8 mm) black flat head screws through the side panel: three along the bottom and one at the front top. Make the threads have engaged, but do not tighten them yet.
- Start one 4-40 3/16" (4.8 mm) black flat head screw through the rear panel into the 2D fastener shown in Figure 49.
- Start one 4-40 3/16" (4.8 mm) black flat head screw at the top right corner of the front panel assembly, nearest the side panel.
- Tighten all six screws
- Replace the 4-40 1/4" (6.4mm) zinc pan head screw holding the KANT3 (or KAT3) board shown in Figure 49.

Attach voltage regulators U13 and U12 to the right side panel as shown in Figure 53 using a 4-40 3/8" (9.5 mm) black flat head screw, #4 inside tooth lock washer and a #4 nut for each regulator as shown. When the screws are tightened the tabs on U12 and U13 should lie flat against the side panel.

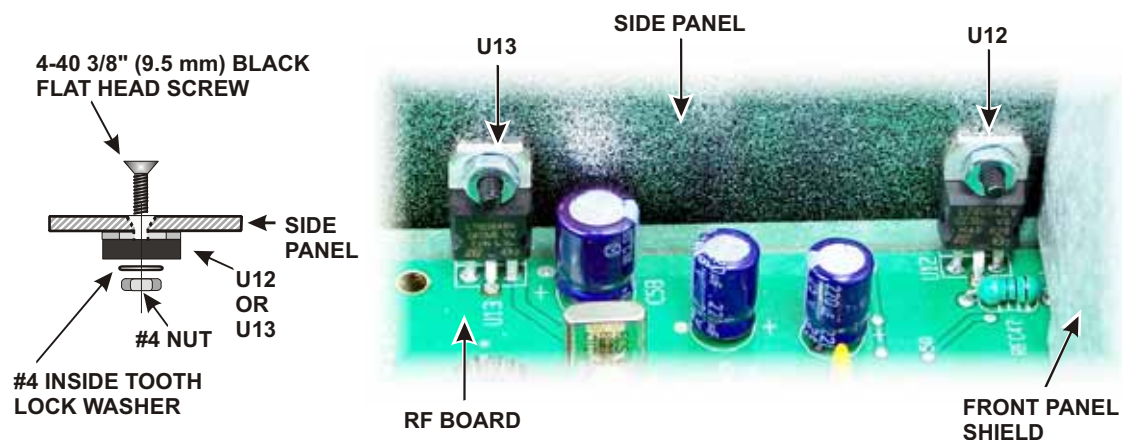


Figure 53. Attaching U12 and U13 to the Right Side Panel.

Replace the left side panel (with the handle) as follows:

- Start the six 4-40 3/16" (4.8 mm) black flat head screws through the panel: three along the bottom, one at the top rear, one at the top front, and one just below the front end of the handle. It is normal to adjust the position of the panels slightly when assembling so the screw holes line up. The cabinet will become structurally sound and rigid with all the panels, including the top and bottom covers, are mounted.
- Start one 4-40 3/16" (4.8 mm) black flat head screw at the top corner of the front panel assembly.
- Tighten all seven screws. **Be sure all the screws are tight, including the screw near the forward end of the handle that threads into the front panel shield.**

Fasten the top center of the front panel assembly to the front panel shield with a 4-40 3/16" (4.8 mm) black flat head screw.

## Resistance Checks

The following resistance checks confirm that the main power busses in the K3 aren't shorted to ground. If any of the values measured are lower than specified, inspect the unit carefully for loose hardware that is caught between components on the boards or for improperly mated connectors.

Use your digital multimeter (DMM) to measure the resistance across the red and black 12VDC IN connectors on the rear panel. The resistance shall be greater than 50K ohms. It may be much higher, depending upon which way you connect the leads. Your DMM may indicate the value is so high it is out of the range of the instrument and as it does when in ohms mode and the probes are not touching anything. If you are not sure, refer to your DMM instruction manual to interpret the reading.

Use your DMM to measure the resistance between the end of R36 and ground at the exposed copper around the screws for the 2D fastener (see Figure 54). The resistance must be greater than 150 ohms.

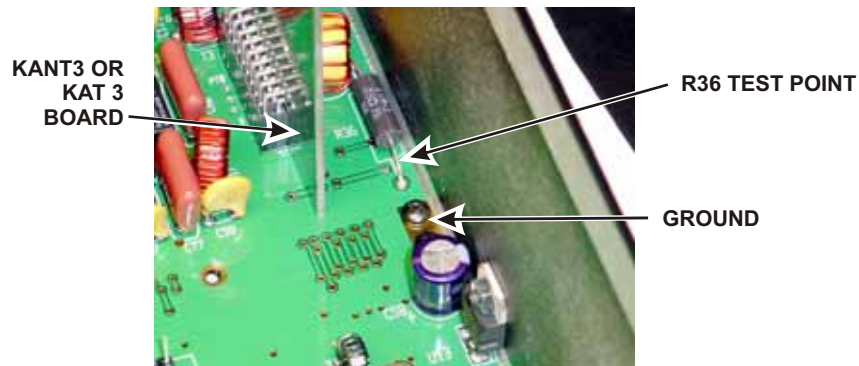


Figure 54. R36 Test Point.

Use your DMM to measure the resistance between the terminal on U12 and ground shown in Figure 55. The resistance must be greater than 500 ohms.

Use your DMM to measure the resistance between the terminal on U13 and ground shown in Figure 55. The resistance must be greater than 150 ohms.

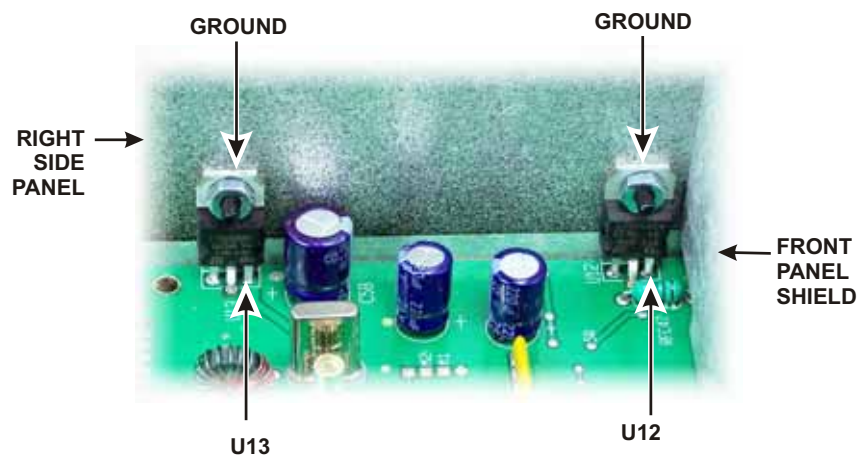


Figure 55. U12 and U13 Test Points.

### ***Initial Power On Check***

The following check confirms that the power supply and power control circuits are working properly. Be sure your K3 passes the resistance tests above before proceeding.

### **⚠ CAUTION!**

**If you see or smell smoke when applying power, turn the K3 off and remove the power cable immediately, then locate the source.**

- Connect your 13.8 VDC power supply to the 12VDC IN connector on the rear panel. Do not connect a key, microphone or other accessories to the K3 at this time.
- Tap (press for less than 1/2 second) the front panel **POWER** button and confirm the LCD display lights. There may be a delay of about 1 second before the display lights. Some front panel LEDs may light as well, and you may notice D33 on the RF board, next to the crystal filters, light. Ignore any error messages on the display and do not try to operate the radio at this time. You'll get to do that soon.
- Tap the front panel **POWER** button again to turn the K3 off and disconnect your external power supply.

### **KREF3 Reference Oscillator**

#### ***KREF3 Description***

The KREF3 module's 49.380-MHz temperature-compensated crystal oscillator (TCXO) is the common reference for the K3's synthesizers. See *Theory of Operation, KREF3*, in the K3 Owner's Manual for more information.

#### ***KREF3 Installation Procedure***

- Check to ensure the KREF3 KTCXO module lead lengths are as shown in Figure 56. If longer than shown, use your diagonal cutters to trim them to length. The objective is to cut the leads only as necessary for the module to fully seat in the socket in the next step.

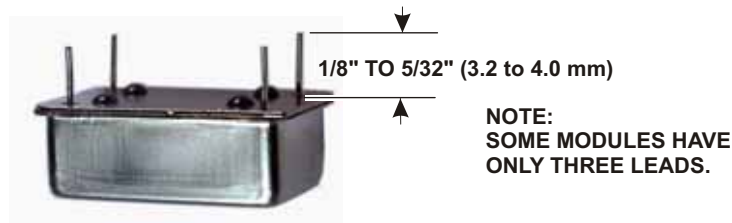


Figure 56. Preparing TCXO Module Leads.

□ Mount the KXTCO module on the KREF3 board as shown in Figure 57. The bottom of the module should rest against the socket. Be certain the leads go into the corner holes in the socket and the black dot is oriented toward connector J6 as shown. If you have a 1ppm high-stability module, the dot may be light brown and not as close to the corner. If the module has only three leads, the missing lead will be in the corner with the dot.

 ESD SENSITIVE!

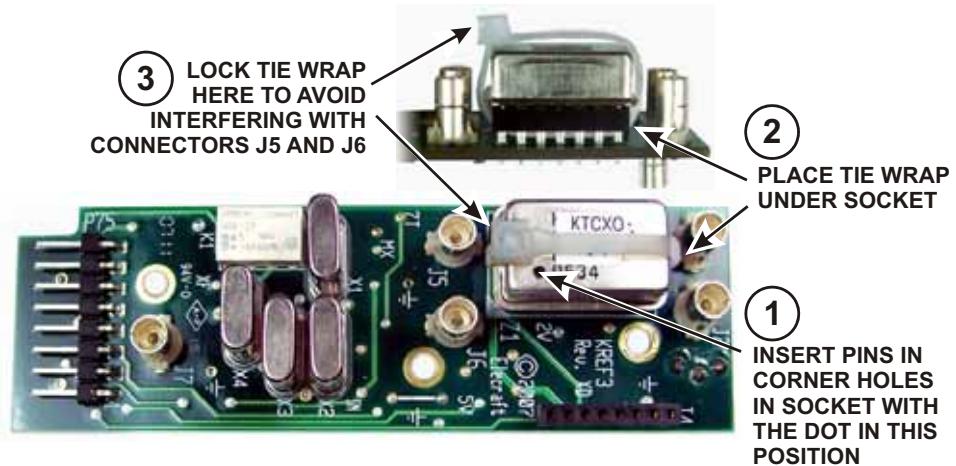


Figure 57. Mounting KTCXO Module on KREF3 Board.

□ Install the KREF3 board on the back side of the front panel shield as shown in Figure 58. The KREF3 board plugs into J75 on the RF board. Be sure you have the KREF3 board connector aligned with J75 so that all the pins mate with the connector.

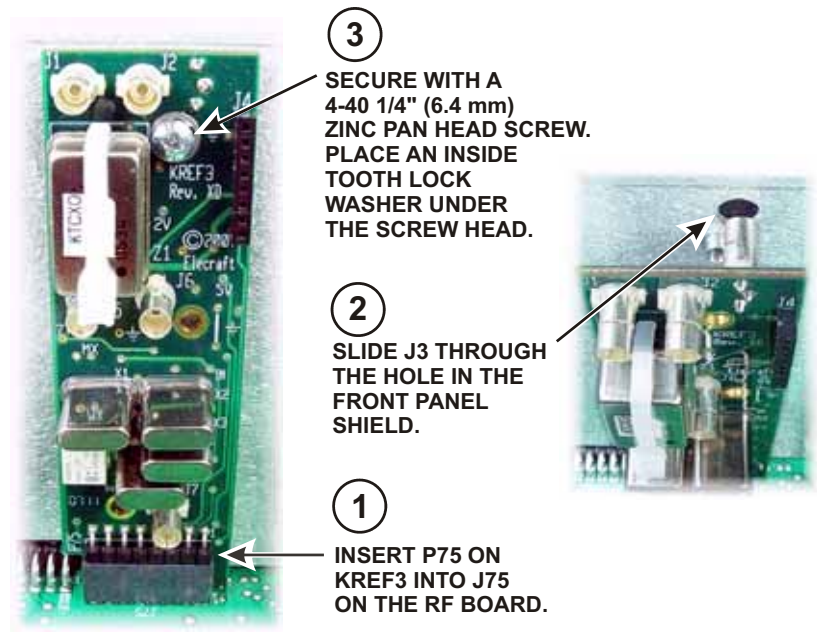


Figure 58. Installing KREF3 Board.

# KSYN3 Synthesizer

## KSYN3 Description

The KSYN3 module is a high-performance, wide-range synthesizer covering 8 to 46 MHz. It uses a crystal-filtered DDS (direct digital synthesis) reference. This in turn drives a VCO with a high C/L ratio, resulting in very low phase noise. See *Theory of Operation, KSYN3*, in the K3 Owner's Manual for more information.

## KSYN3 Installation Procedure

☐ Install the KSYN3 board on the back side of the front panel shield as shown in Figure 59. The KSYN3 board plugs into J73 on the RF board. Be sure the connectors are aligned so that all the pins go into the corresponding socket holes on J73.

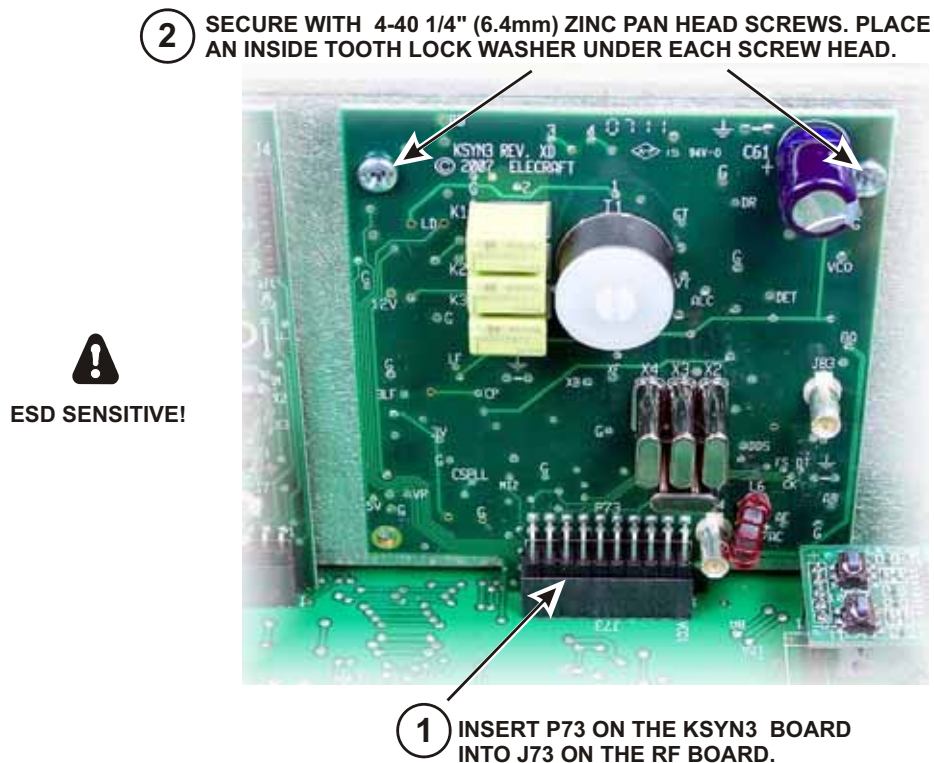


Figure 59. Installing the KSYN3 Board.

☐ Locate the three TMP cables. They are 1/4" (6.4mm) diameter coaxial cables with connectors at each end as shown in Figure 60.

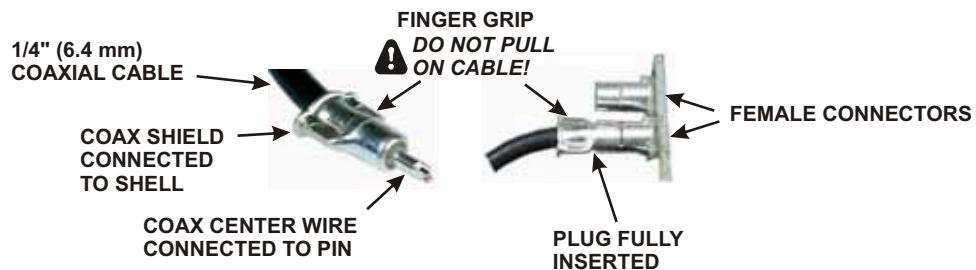


Figure 60. TMP Cable Connectors.

Install the three TMP cables between connectors on the KREF3 board, the main RF board and the KSYN3 board as follows. Handle the connectors by the finger-grip area shown in Figure 60, especially if you unplug a connector. **Do not pull on the coaxial cable to unplug a connector!** When mating the connectors, be sure the plugs are fully inserted as shown in Figure 60. To make the connectors easier to mate, first be sure the center pin is started in the socket, then you may twist the connector back and forth while holding it by the metal ears if needed to seat it fully as shown in Figure 60.

- KREF3 board J7 to RF board J65.
- KREF3 board J6 to RF board J81.
- KREF3 board J2 to KSYN3 board J83.

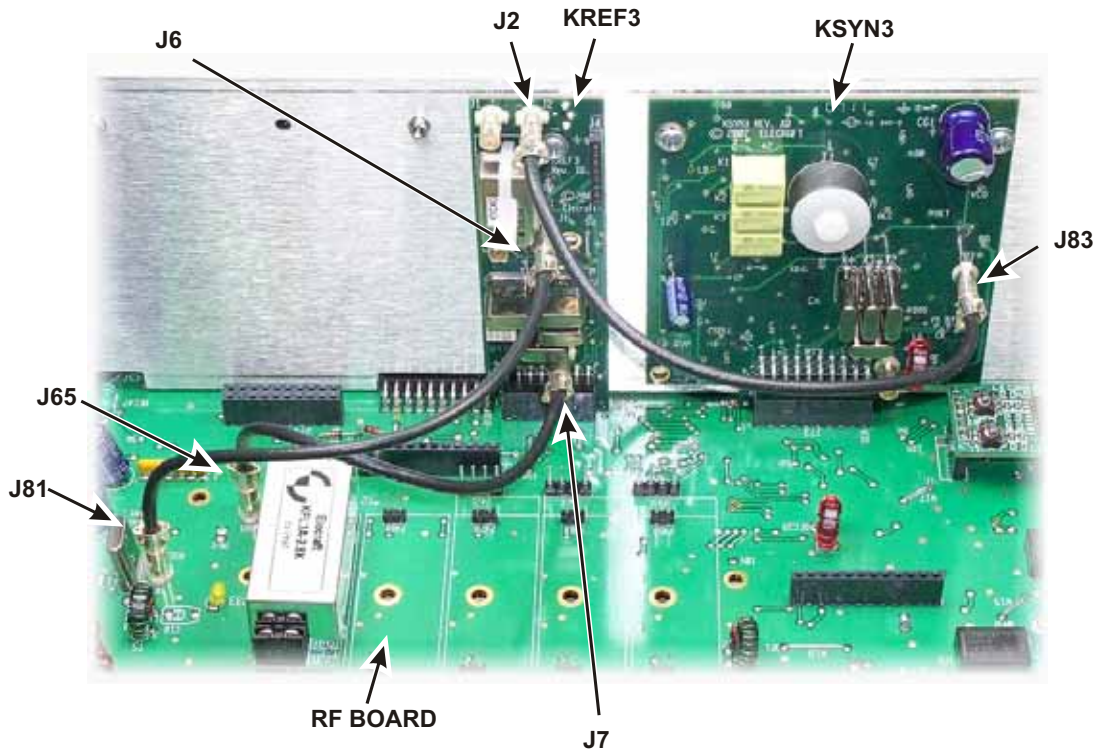


Figure 61. Installing KREF3 TMP Cables.

## Loudspeaker

### *Loudspeaker Description*

The built-in loudspeaker is mounted on the top cover. A grill cloth covering the sound holes keeps dust and debris from falling into the speaker cone. The loudspeaker is equipped with a magnetic shield to avoid unwanted interaction with nearby circuits.

### *Loudspeaker Installation Procedure*

Locate the top cover and check the inside for any masking tape still covering screw holes. If found, peel it off.

Mount the chassis stiffening bracket on the underside of the cover as shown in Figure 62. Do not use washers.

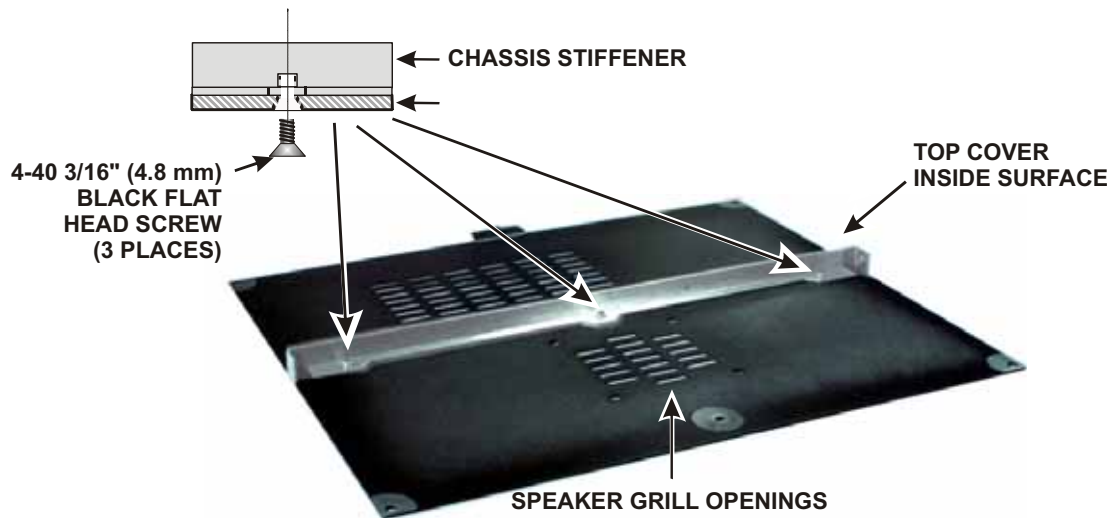


Figure 62. Attaching Chassis Stiffener to Top Cover.

Trim the grill cloth to cover the speaker grill openings and overlap the four holes for the loudspeaker mounting screws. Mark and cut four holes in the grill cloth for screws to pass through the cloth. The grill cloth is shown as it must fit after the speaker is mounted in Figure 63. If you install the KPA3 100-watt amplifier, the stiffener will be attached to the chassis and cannot be removed with the cover. In that case, the grill cloth must be trimmed as shown so it cannot become trapped between the chassis stiffener and the top cover.

### **⚠ CAUTION!**

**Failing to install the fiber washers as shown in the next step or over-tightening the screws so that the speaker mounting flanges are distorted may damage the speaker, causing distorted, fuzzy sound.**

Mount the speaker using the hardware shown in Figure 63. A suggested procedure for doing this is as follows:

- Find a book or other flat-smooth surface that is about the size of the top cover.
- From the top, place the screws in the four holes at the corners of the speaker grill area.
- Cover the screw heads with the book and, holding it in place against the top cover, invert the cover and lay it with the book on your work table so the bottom side is facing upwards.
- Trim and cut screw holes in the grill cloth as needed and position it over the four screws that are now held in place by the book. Trim the grill cloth so the cloth does not touch the stiffener.
- Place a fiber washer on each screw so it rests on the grill cloth.
- Position the loudspeaker on the four screws so they pass through the holes in the flanges. Orient the speaker so the wire exits toward the rear (the side nearest the stiffener).
- Place a #4 internal tooth lock washer on each screw.
- Start a 4-40 nut on each screw.
- Pick up the entire assembly and tighten all four screws. ***Do not tighten the screws enough to bend the speaker flanges!***

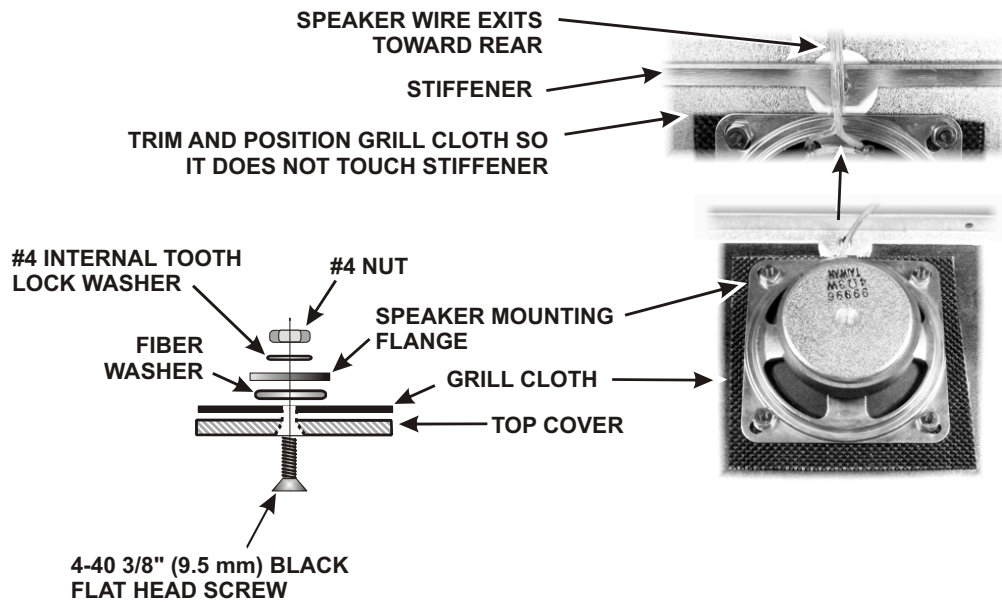


Figure 63. Mounting Loudspeaker.

Install the shield over the speaker magnet as shown in Figure 64.

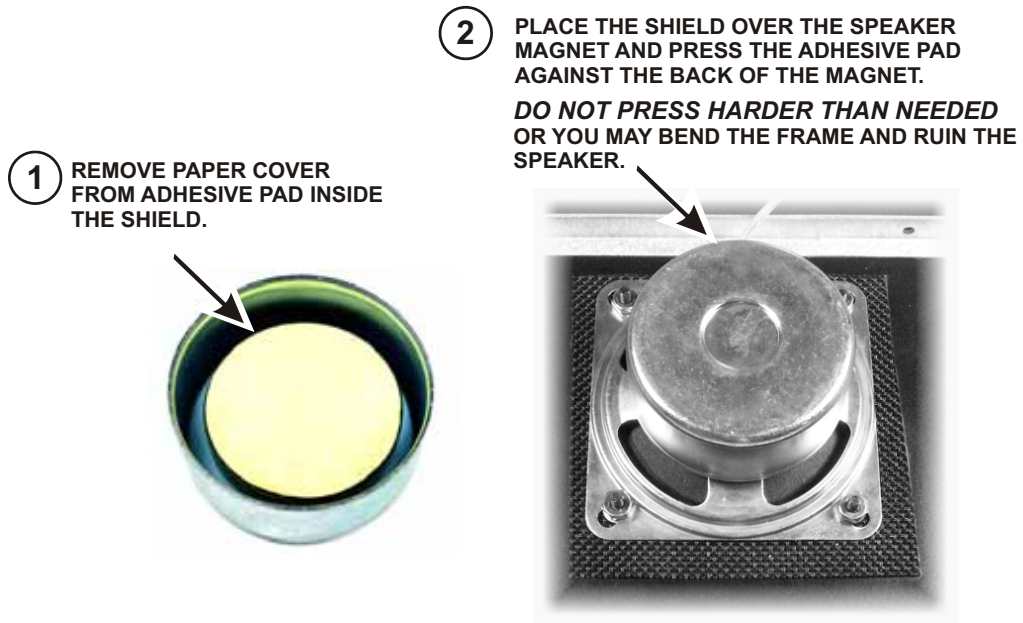


Figure 64. Installing Speaker Magnet Shield.



## KPA3 Shield

If you are *not* planning to install the KPA3 module at this time, skip this section and go directly to *Bottom Cover* on page 48. Only the KPA3 shield is installed at this time to avoid rework later. You will be directed to finish installing the KPA3 module after initial testing and calibration of your K3.

### *KPA3 Shield Description*

The KPA 3 Shield is part of the optional KPA3 100-watt amplifier module. It isolates the high-level RF circuits in the KPA3 from the rest of the K3 and provides mechanical support for the amplifier module itself.

### *KPA3 Shield Installation Procedure*

Remove the shield from the KPA3 Option kit and position it over the holes in the RF board as shown in Figure 65. The holes in the shield must line up with the holes in the RF board.



SET THE SHIELD ON THE RF BOARD WITH THE REAR FOOT ABOVE THE LPA BOARD CONNECTOR, THEN MOVE IT BACK UNTIL THE REAR FOOT SITS ON THE THE RF BOARD AND THE SHIELD IS AGAINST THE REAR PANEL.



Figure 65. Positioning the KPA3 Shield.

Attach the shield to the RF board and to the rear panel as shown in Figure 66. The screws, washers and nut are in the KPA3 Option kit. The standoffs are part of the K3 kit hardware.

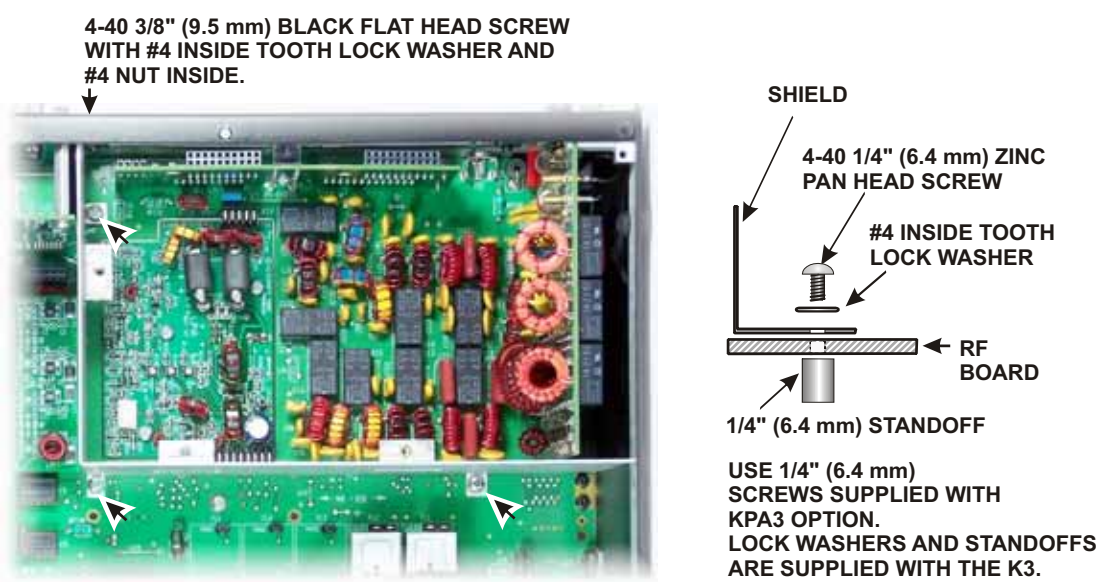


Figure 66. Attaching the KPA3 Shield.

Remove the stiffener bar from the top cover and install it on the chassis as shown in Figure 67. The screws, lock washers and nuts required to attach it to the shield are in the KPA3 Option kit. The black screws used to attach it to the side panels are part of the K3 kit hardware.

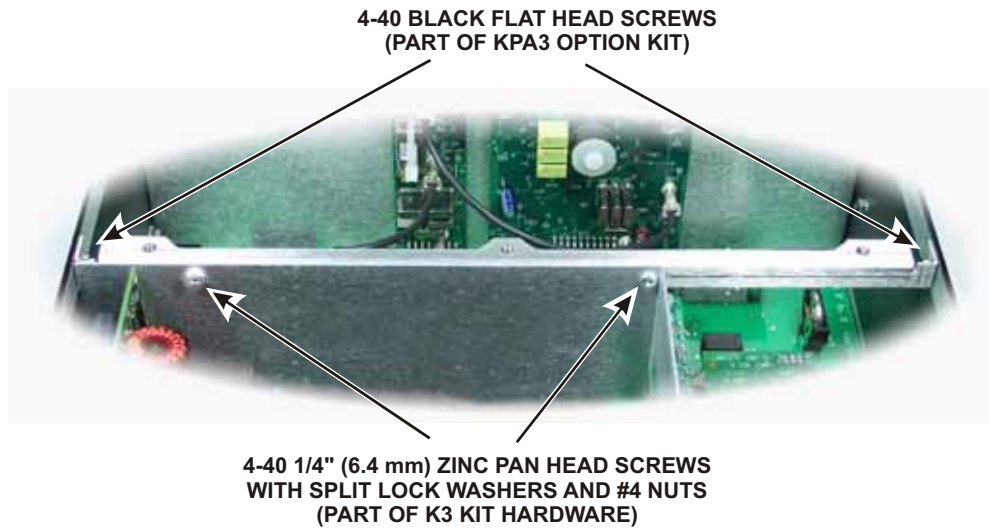


Figure 67. Installing the Chassis Stiffener Bar.

## Bottom Cover

### Bottom Cover Description

The bottom cover is divided into two parts, the rear and forward sections. The rear section is thicker than the forward section to act more efficiently as a heat sink for the LPA transistors. The bottom covers attach to standoffs as well as the 2D fasteners on the bottom of the RF Board. A folding tilt stand and feet are mounted on the cover panels.

### Bottom Cover Hardware Installation

Install the standoffs on the bottom of the RF board shown in Figure 68. If you installed the KPA3 shield, three of the four standoffs required are already in place. *If so, be sure to install the remaining standoff!*

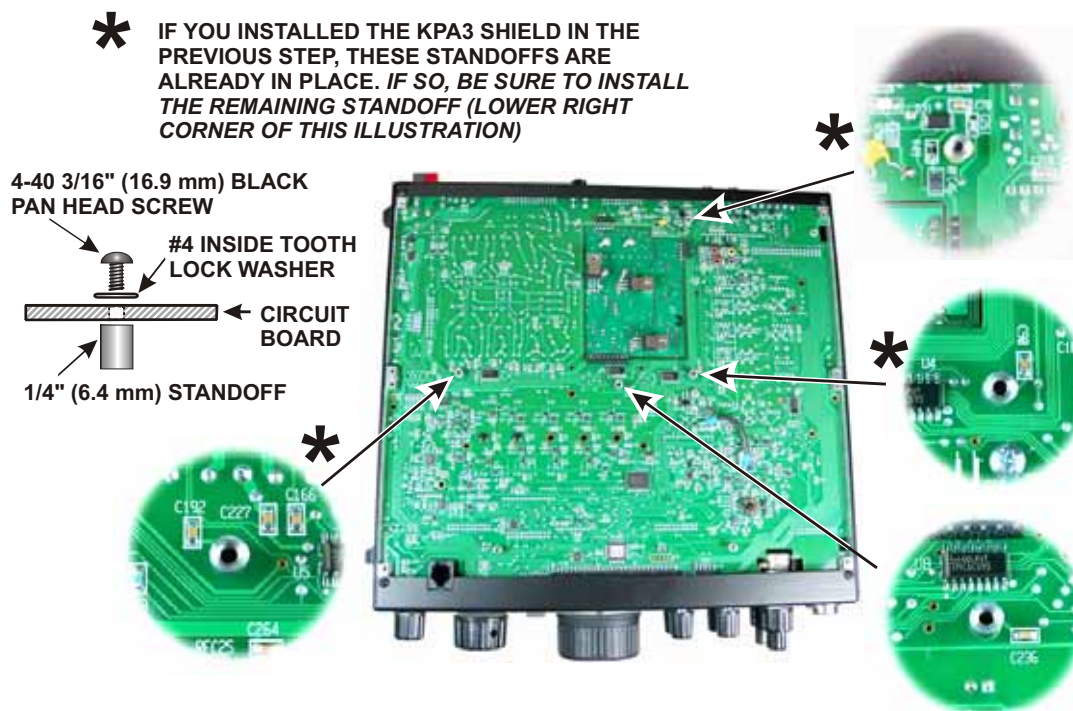


Figure 68. Installing Standoffs on RF Board.

- Identify the bottom cover forward section by test fitting it on the bottom of the K3. The forward section is the thinner panel with a notch along one edge (see Figure 69).
- One side of the cover is fully painted. That is the outside. The other side has areas of bare metal left to ensure good electrical contact with the other cabinet parts. Check the inside surface for any masking tape left from the painting process. If found, peel it off.
- Attach one tilt stand foot to bottom cover section A as shown in Figure 69 using a 4-40 7/16" (11 mm) zinc pan head screw. The foot goes on the fully-painted side of the cover, oriented as shown. Be sure the cut-away side of the foot is farthest from the edge of the panel and the hole for the tilt stand faces the holes for the other foot. Use a #4 inside tooth lock washer and #4 nut to secure each screw. Do not tighten the hardware. Start the nuts onto the screws only a few turns so the foot is free to move about.

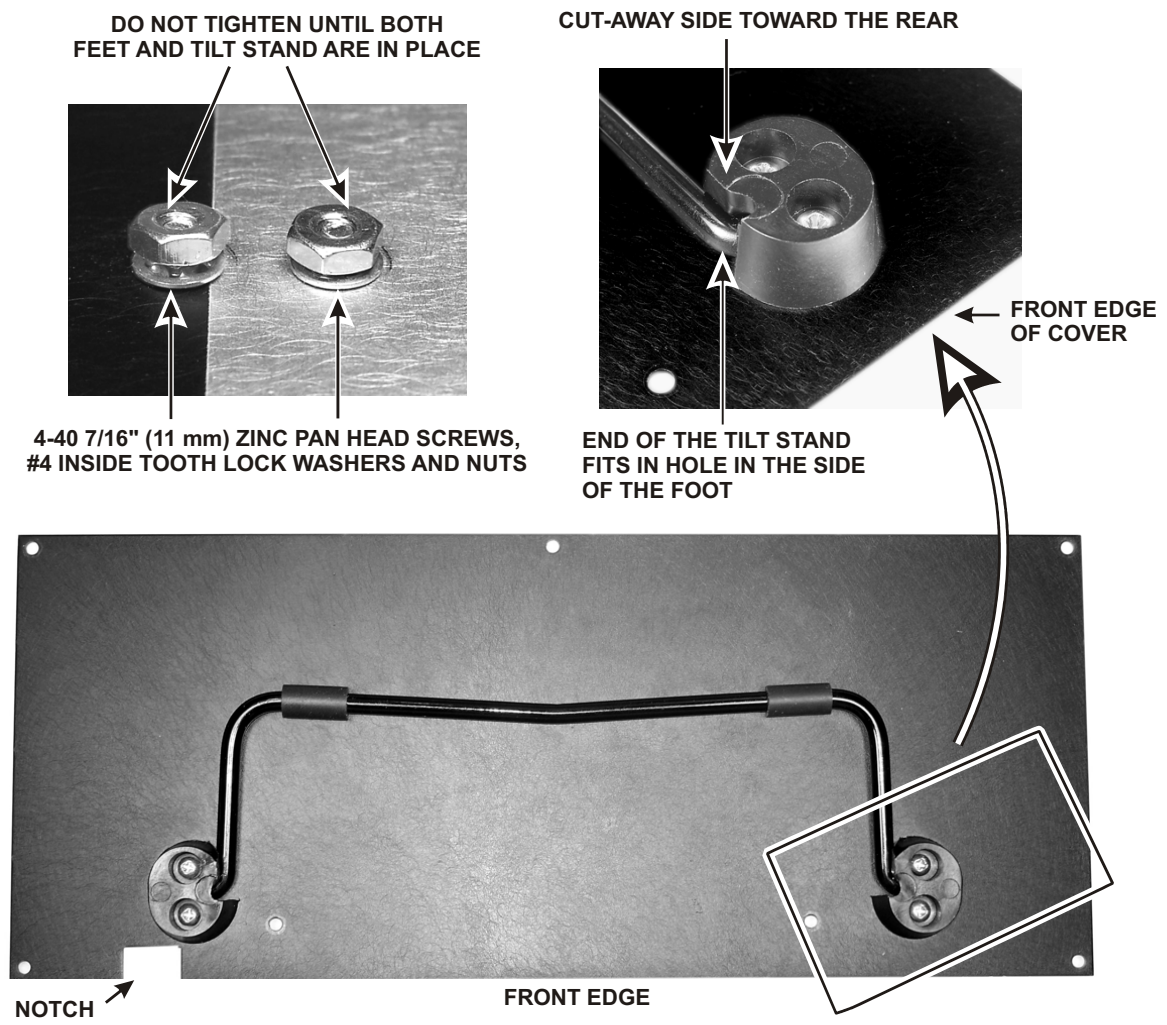


Figure 69. Installing Tilt Stand.

- Attach the second tilt stand foot, making sure the ends of the tilt stand are resting in the holes provided in the feet, then tighten all four screws to secure the feet and stand to the panel.

Locate the rear bottom cover section. This cover has eight rectangular slots cut in it. Like the front section bare metal is exposed in some areas. That side will face inside the K3. The bare metal ensures good electrical contact with the other cabinet parts and good thermal contact with the heat sinks for Q2, Q4 and Q5 on the LPA circuit board.

Check the inside surface of the bottom cover for any masking tape that may have been left from the painting process. If found, peel it off. Two of the screw holes inside bottom cover section B have *not* had the paint removed from them. These are the mounting holes for the two rear feet. Attach each foot as shown in Figure 70.

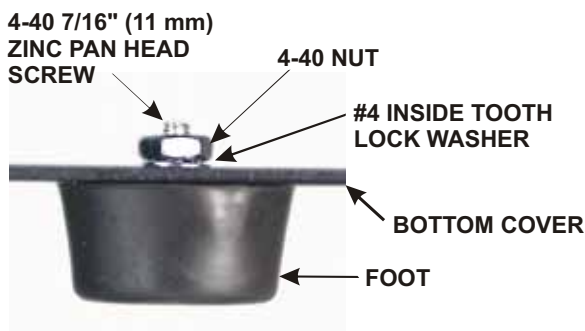


Figure 70. Installing Rear Feet.

Set both bottom covers aside in a safe place. They will be mounted on the K3 later.

## KNB3 Noise Blanker

### KNB3 Noise Blanker Description

The KNB3 is one of two noise blanker systems in the K3. It is a narrow I.F. pulse blanker that plugs into the RF board. See *Theory of Operation, Noise Blanker* in the K3 Owner's Manual for more information

### KNB3 Installation

Install the standoff for the noise blanker as shown in Figure 71. The location of J77 is to the left of crystal filter position FL5 on the RF board. Be sure to put *two* split lock washers between the standoff and the RF board as shown.

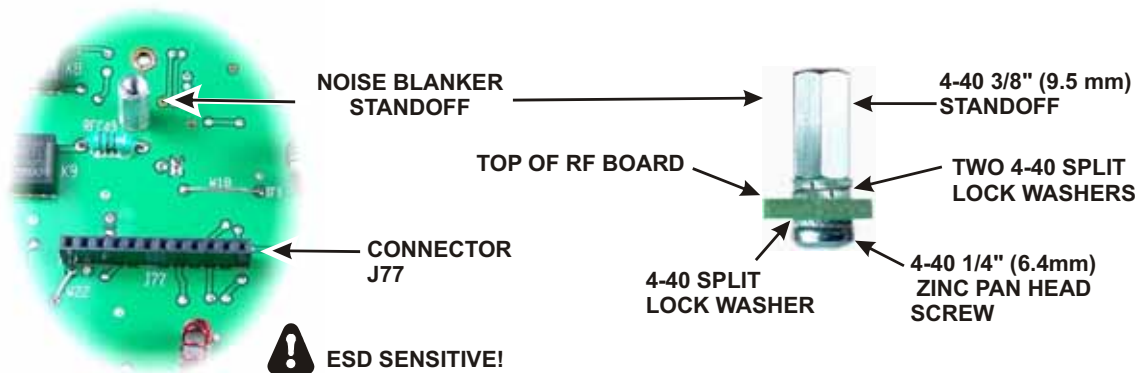


Figure 71. Installing Noise Blanker Standoff.

- Plug the noise blanker board into J77 and attach it to the standoff using the hardware shown in Figure 72.

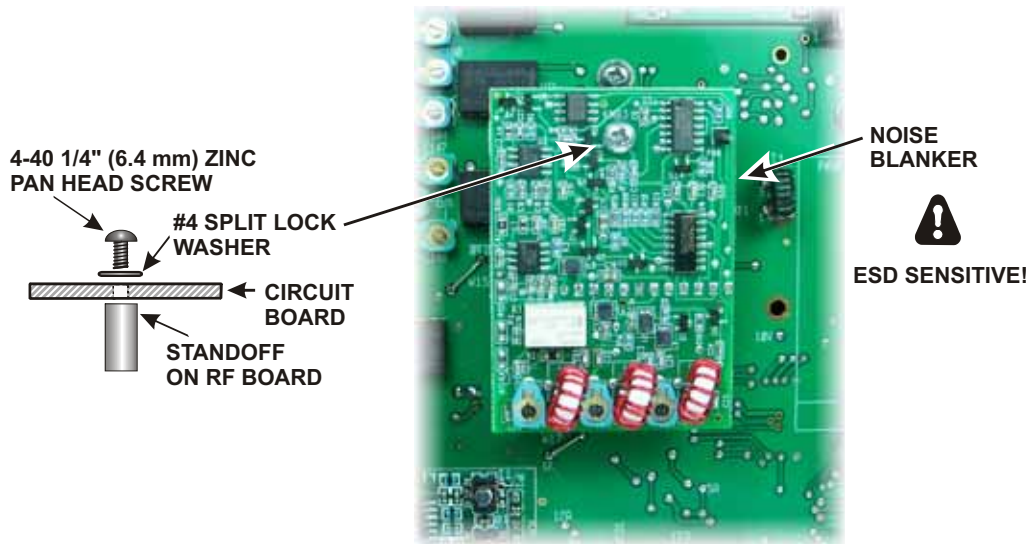


Figure 72. Installing the Noise Blanker Board.

## Battery BT1

### *Battery BT1 Description*

BT1 is a 3-volt lithium coin cell that provides the operating voltage for the real-time-clock IC (RTC) on the front panel when the K3 is turned off. Depending on the type of cell, BT1 could last from 2 to 10 years, thanks to the extremely low current drain of the RTC – on the order of a few microamperes. The RTC keeps track of the full date and 24-hour time, either of which can be displayed on the VFO B portion of the LCD.

### *Battery BT1 Installation Procedure*

- Insert the CR2032 cell into battery holder BT1 as shown in Figure 73.

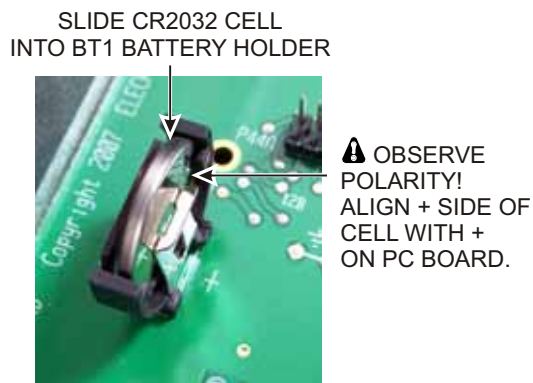


Figure 73. Installing BT1.

## KBPF3 General Coverage Receive Option

If you have the KBPF3 General Coverage Receive option kit, install the board as follows. Otherwise skip this section and go directly to *Power Amplifier Jumper Block* on page 52.

### ***KBPF3 Description***

The KBPF3 extends the receive coverage outside of the Ham bands over the range of 500 KHz to 30 MHz and from 48 MHz through 54 MHz. Only the receiver coverage is extended. The transmitter frequencies remain limited to the Amateur bands.

### ***KBPF3 Installation***

☐ Install the board on the standoffs you installed earlier as shown in Figure 74. The screws and lock washers needed are supplied with your KBPF3 Option kit. There are three connectors on the bottom of the KBPF3 board that must be properly mated to P44A, P44C and P44E on the RF board. Even though the connectors are hard to see if the KPA3 shield is installed, they can be aligned as follows:

- Set the KBPF3 board in place over the standoffs, aligning it so the holes in the KBPF3 board are aligned with the tops of the standoff. This will align the connectors.
- Press down on the KBPF3 board to mate the connectors at the end near battery BT1 and along the side nearest the LPA board or, if installed, the KPA3 shield, while checking to ensure that the holes in the board are aligned with the holes in the standoffs. Note that simply installing the mounting screws will not ensure the 3-pin connectors are fully mated. When properly mounted the KBPF3 board should rest on top of the standoffs and be parallel with the RF board underneath.

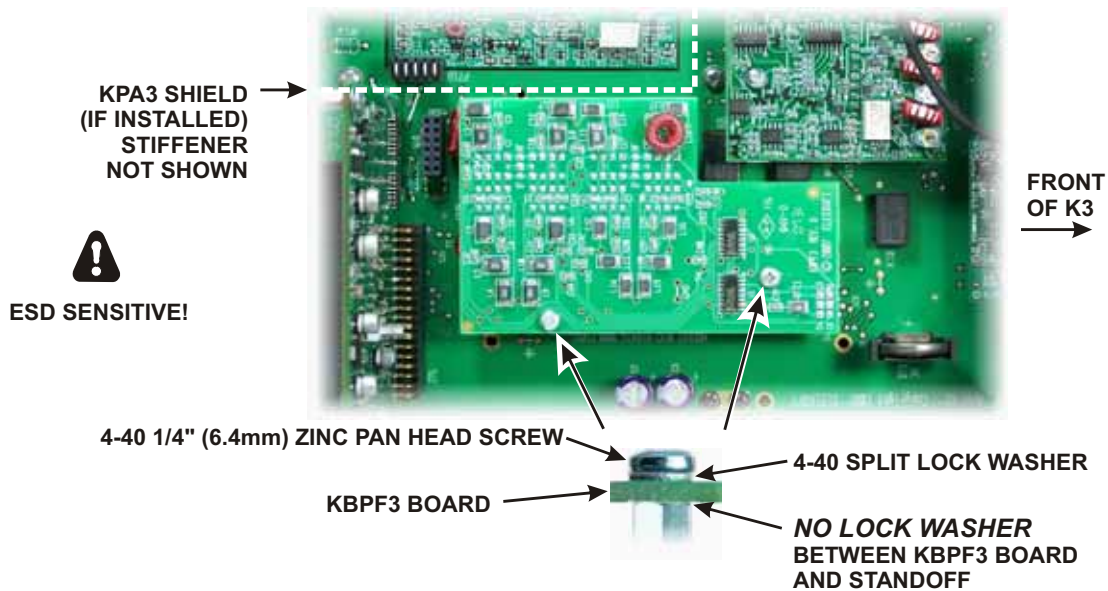


Figure 74. Installing the KBPF3 Option Board.

## Power Amplifier Jumper Block

The Power Amplifier (PA) jumper block is required to operate the K3 without the optional KPA3 100 watt power amplifier module installed. Your RF board was shipped with the jumper block installed. Even if you are planning to install the KPA3 at this time, do not remove it until instructed to do so. You will be performing some essential tests and calibration procedures before the KPA3 module is installed.

If you remove it for any reason before installing the KPA3, replace it as shown in Figure 75. ***Inspect the position of the jumper block carefully to ensure it is mated with the four pins at the ends of both connectors. Your K3 may be damaged when power is applied if the jumper block is positioned incorrectly!***

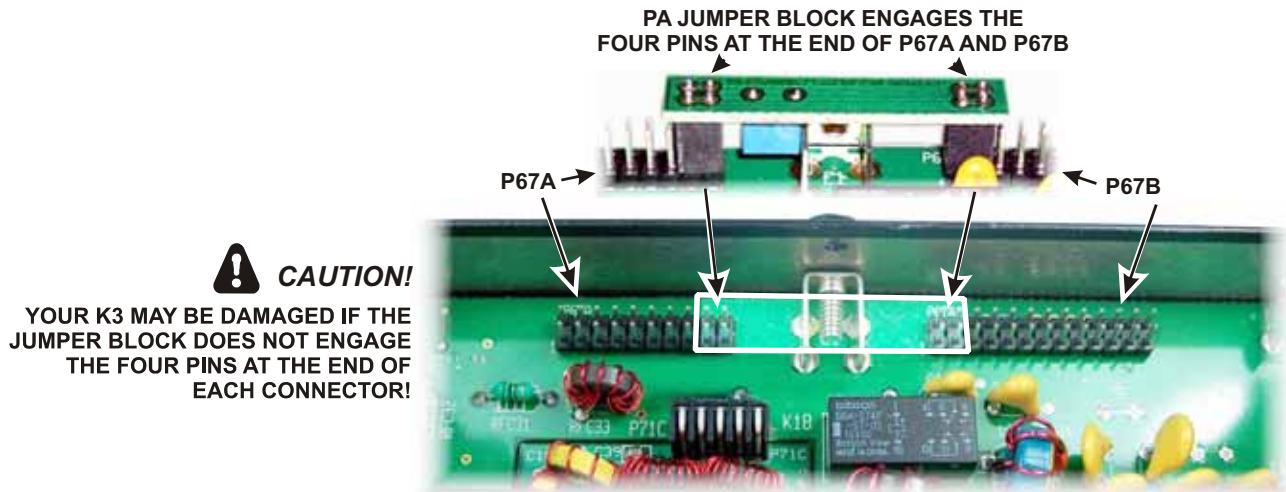


Figure 75. Installing the PA Jumper Block.

## Finishing the Enclosure

Even though you may be planning to install the KPA3 100 watt amplifier at this time, you must complete the enclosure to run some essential tests and calibration procedures first. These tests require the enclosure panels be in place, particularly the bottom cover that acts as a heat sink for the low power amplifier (LPA) transistors.

### ***Fan Opening Cover***

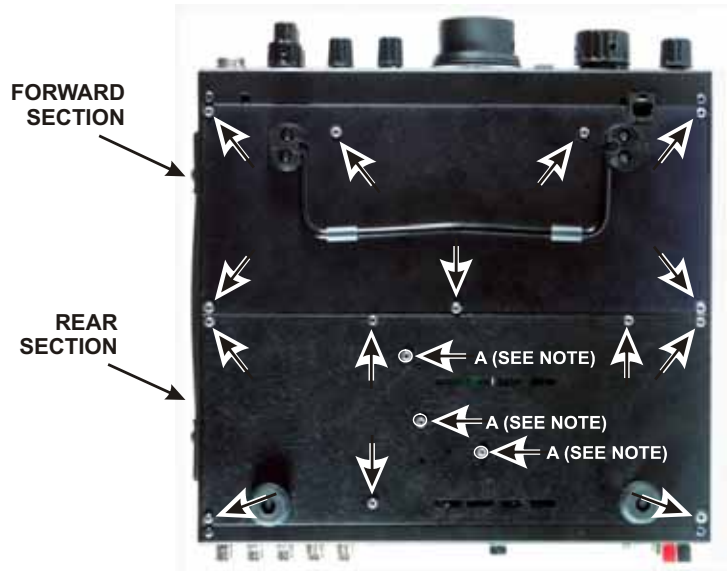
A large opening in the rear panel is provided for fans required to provide cooling air for the KPA3 100-watt amplifier module.

If you have the KPA3 100-watt amplifier and plan to install it before operating your K3 on the air, you may leave this panel off. Otherwise, install the larger blank panel in the opening on rear panel with a 3/16" (4.8 mm) black pan-head screw into the threaded bushing at each corner. Do not use washers under the screws.



## Bottom Covers

Turn the K3 over so the bottom is exposed. Position the forward section of the bottom with the feet and bail toward the front as shown in Figure 76. Attach the cover with seven 3/16" (4.8 mm) black pan head screws at the positions shown. Do not use washers.



### NOTE

ALL SCREWS EXCEPT THOSE MARKED "A" ARE 3/16" BLACK PAN HEAD. DO NOT USE WASHERS.

THE THREE SCREWS MARKED "A" MUST BE 1/4" BLACK PAN HEAD WITH INSIDE TOOTH LOCK WASHERS UNDER THE SCREW HEADS.

### CAUTION!

POWER TRANSISTORS IN YOUR K3 MAY FAIL PREMATURELY IF THE SCREWS MARKED "A" ARE NOT INSTALLED WITH LOCK WASHERS AS SHOWN!

Figure 76. Installing Bottom Covers.

Attach the rear cover section as follows (see Figure 76):

- Position the cover so the holes marked A line up with the transistors on the LPA board. The remaining holes will line up with 2D fasteners and standoffs.
- Start three 4-40 1/4" (6.4 mm) black pan head screws into the transistors through the holes near the center with a #4 inside tooth lock washer under each screw head. Do not tighten the screws yet.
- Start seven 4-40 3/16" (4.8 mm) black pan head screws into the remaining holes. Do not use washers.
- Tighten all ten screws.

## Top Cover

Even if you have the KPA3 100-watt module to install, install the top cover and speaker at this time for initial testing and calibration of the basic 10-watt K3 configuration.

- Connect the speaker cable to P25 of the KIO3 board as shown in Figure 77. If you have the KPA3 shield installed, route the speaker wire under the stiffener bar.

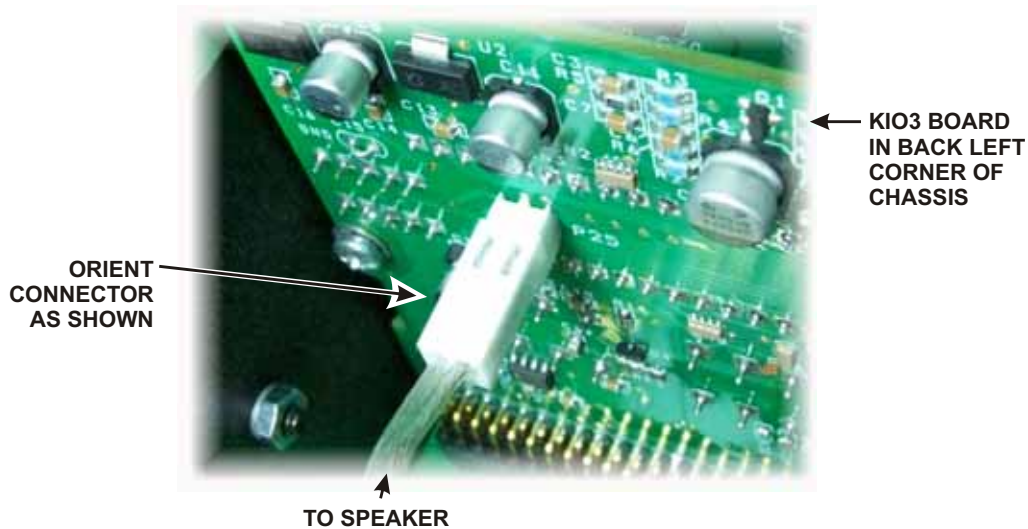


Figure 77. Connecting Speaker to KIO3 Board.

- Place the top cover on the K3 with the tab at the rear extending under the lip of the rear panel. Secure the top cover with six 4-40 3/16" (4.8 mm) black flat head screws along the front and rear edges of the cover. You may find it necessary to loosen screws at the top of the side, front and rear panels to adjust their position so the top cover fits properly.

- If you have the KPA3 shield installed, place three 4-40 3/16" (4.8 mm) black flat head screws through the holes across the middle of the cover to secure it to the stiffening bar. If you have not installed the KPA3 shield, the stiffening bar still is attached to the top cover where you mounted it to measure the speaker grill cloth for trimming. Place a 4-40 3/16" (4.8 mm) black flat head screw into each side panel to secure the ends of the stiffening bar.

**⚠** *The screws that hold the top cover in place are an important part of the structural design that provides excellent structural rigidity in spite of its light weight. Be sure all the screws are in place and tight whenever you replace the cover or other panels.*

*When removing the top cover in the future, the normal procedure is to remove the nine screws on top, leaving the stiffening bar on the chassis (see Figure 78). If the KPA3 100-watt amplifier is installed, this is the only way the top cover can be removed because the rear shield installed with the KPA3 attaches to the stiffening bar.*

- ① REMOVE 9 SCREWS HOLDING TOP COVER.      ② TO OPEN COVER, PRESS HERE TO TILT FRONT EDGE UP OR PLACE UNIT ON ITS SIDE FEET, THEN TIP FARTHER SO THE TOP COVER SWINGS OPEN.

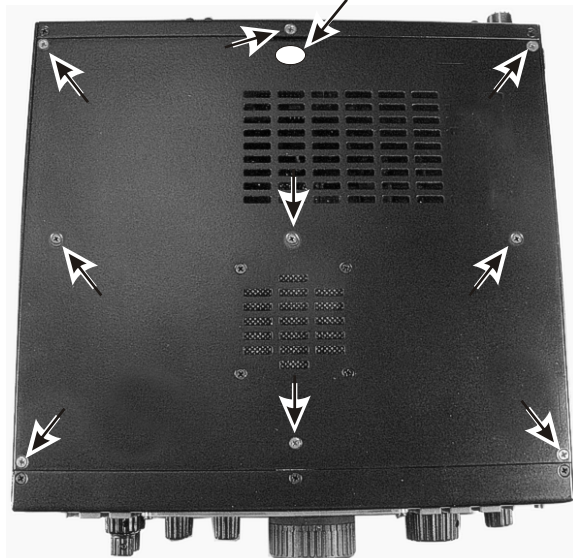


Figure 78. How to Remove the Top Cover.

This completes the assembly of your K3/10 Transceiver. Next perform the Initial Test and Calibration procedures below to ensure your K3 is operating properly. Once they have been completed you can proceed to install other options, including the KPA3 100-watt amplifier module, at any time. Each option is supplied with its own installation manual.

**⚠ PARTS LEFT OVER?**

*You may find that you have extra screws, washers or nuts after completing the assembly of your K3. This is normal. Extras of parts most easily lost during assembly are frequently included.*

## Test and Calibration

**⚠ YOUR K3 WILL NOT OPERATE, OR WILL NOT OPERATE CORRECTLY, until you complete the Test and Calibration procedures below, including all the steps under Synthesizer Calibration, Filter Setup (all five filter procedures listed) and the TX Gain Calibration.**

It's time to apply power! In the following tests and procedures you will check out and calibrate essential functions of your basic K3. You must complete these procedures before operating your K3 at low power or before installing a KPA3 100-watt power amplifier option.

Have your K3 Owner's Manual handy. Detailed procedures are in your Owner's Manual where you can find them easily in the future if you need them.

**⚠ Using Tap/Hold Switches:** Most K3 switches have two functions. *Tapping* activates the function labeled on the switch. *Holding* (~1/2 sec.) activates the function labeled beneath the switch.

### Initial Power Checks

Connect your 11-16 VDC power supply to the red and black 12VDC IN connector on the back of your K3. Don't connect anything else to your rig until instructed to do so.

On the front panel, tap **POWER** to turn the K3 on. The LCD display should illuminate as it did before. It will probably show an Error message, e.g. ERR PLL or ERR PL1. This is normal! It is reporting that the synthesizer has not been calibrated. Tap **DISPLAY** to clear the error message. Other error messages may follow, depending upon which modules you have installed, indicating that they have not been initialized yet. Press display until you have cleared the error messages.

### Synthesizer Calibration

Hold **CONFIG** to access the configuration menu, then rotate VFO B to display TECH MD. Set the TECH MD parameter to ON with VFO A.

Refer to the *Calibration Procedures* in your Owner's Manual and perform the *Synthesizer* calibration.

When the calibration process is completed, press the BAND switch to cycle through all the bands from 160 meters through 6 meters and verify that there are no CAL PLL error messages on the display. That indicates that the synthesizer is calibrated on all the bands.

### Filter Setup

Turn to the *Crystal Filter Installation and Setup* section of your Owner's Manual and perform the following procedures. If you have installed standard Elecraft 5-pole filter(s) you will need the FREQ OFFSET data you recorded earlier on page 12.

- *Filter Bandwidth Setup*
- *Filter Center Frequency Setup*
- *Receive Filter Enables*
- *Filter Loss Compensation*
- *Transmit Filter Selection*

## **TX Gain Calibration**

Turn to the *Calibration Procedures, Transmitter Gain* section in your Owner's manual and perform the , *Low-Power (5W) TX Gain Calibration* procedure.

## **Option Modules**

### **Enable Modules**

Enable the KNB3 noise blanker and, if installed, the KBPF3, KAT3 and KXV3, options modules as described in the *Option Module Enables* section of your Owner's Manual. Even though they are installed, these modules will not function until they are enabled.

### **KPA3 100-Watt Amplifier Installation**

If you purchased the KPA3 100-watt amplifier option, turn to the KPA3 Option manual *Installation Procedure* to complete installation and testing now.

## **Optional Calibration Procedures**

### **Wattmeter Calibration (Optional)**

The wattmeter is reasonably accurate as it is supplied. However, if you have an accurate external wattmeter you can adjust the K3 to match its readings at low power (5 watts), high power (50 watts), and, if you have the KXV3 module installed, at 0.5 milliwatts output at the KXV3 transverter interface. Refer to *Calibration Procedures, Wattmeter* in your Owner's Manual.

### **Reference Oscillator Frequency Calibration (Optional)**

Both the standard 5 ppm and optional 1 ppm reference oscillators can be calibrated for improved accuracy if you have a highly-accurate frequency counter or by zero-beating a known, accurate on-air signal such as a commercial broadcast station. Refer to *Calibration Procedures, Reference Oscillator* in your Owner's manual.

### **S-Meter Calibration (Optional)**

The S-meter calibration is normally quite accurate with the default settings provided. If you have an accurate 50-ohm, 50-microvolt signal generator (such as the Elecraft XG1 or XG2) you can calibrate the S-meter yourself. Refer to *Calibration Procedures, S-Meter* in your Owner's manual.

# Appendix A Illustrated Parts List

Your kit contains a number of envelopes, boxes and packages of parts. Check the contents of each one carefully against the following lists.

## Printed Circuit Boards

Each board is packaged in its own ESD-safe bag identified by the part numbers shown below.

**⚠ CAUTION!**

***DO NOT DISTURB ANY ADJUSTMENTS ON THE BOARDS***

Each board was tested and aligned for optimum performance at the factory. Any change to these adjustments will degrade the performance of your K3 or prevent its operation altogether. All user calibrations and adjustments are done in firmware using the front panel menus. These are described at the appropriate points in the assembly procedures and in the Owner's Manual.



ILLUSTRATION	DESCRIPTION	QTY	ELECRAFT PART NO.
	Front Panel Printed Circuit Board Assembly ⚠ <i>ESD Sensitive</i>	1	E850242
	K3 DSP Printed Circuit Board Assembly ⚠ <i>ESD Sensitive</i>	1	E850233

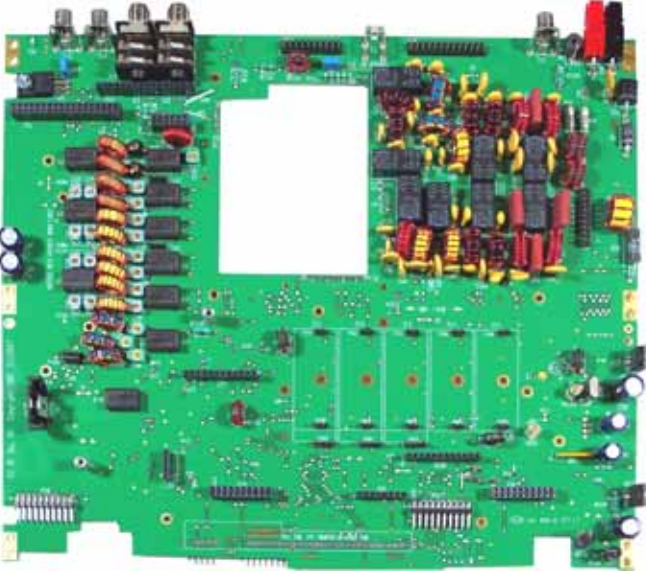



ILLUSTRATION	DESCRIPTION	QTY	ELECRAFT PART NO.
 <p>A green printed circuit board (PCB) populated with various electronic components. It features several integrated circuits, numerous resistors, and capacitors. There are also several connectors along the edges, including a large multi-pin connector at the bottom and several smaller ones at the top and sides. A large white rectangular area is visible in the upper center of the board.</p>	<p>RF Board  <b>⚠ ESD Sensitive</b></p>	<p>1</p>	<p>E850261</p>
 <p>A small green PCB assembly with two dark brown multi-pin connectors labeled J67A and J67B. A blue component labeled C241 is mounted in the center of the board.</p>	<p>PA Jumper Block Assembly (pre-installed on RF board)</p>	<p>1</p>	<p>E850322</p>
 <p>A green PCB populated with various electronic components. It features several integrated circuits, numerous resistors, and capacitors. There are also several connectors along the edges, including a large multi-pin connector at the bottom and several smaller ones at the top and sides. The board is labeled 'LPA REV XT'.</p>	<p>Low Power Amplifier (LPA) Board  <b>⚠ ESD Sensitive.</b></p>	<p>1</p>	<p>E850256</p>
 <p>A green PCB populated with various electronic components. It features several integrated circuits, numerous resistors, and capacitors. There are also several connectors along the edges, including a large multi-pin connector at the bottom and several smaller ones at the top and sides. The board is labeled 'K3 REV XF' and 'ELECRAFT 2007'.</p>	<p>K3 Mixer Board  <b>⚠ ESD Sensitive.</b></p>	<p>1</p>	<p>E850257</p>



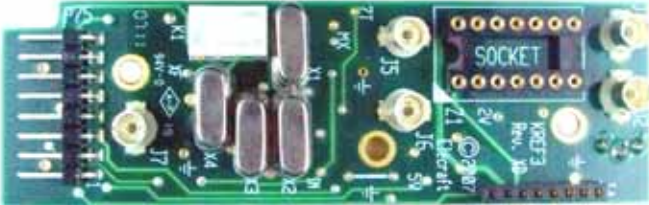
ILLUSTRATION	DESCRIPTION	QTY	ELECRAFT PART NO.
	<p>KNB3 Noise Blanker Board</p> <p><b>⚠ ESD Sensitive.</b></p>	1	E850280
	<p>KANT3 Antenna Input Module</p> <p><b>Note:</b> This board is not supplied if you purchased the KAT3 automatic antenna tuner option with your K3 kit.</p>	1	E850248
	<p>KREF3 Board (Bag includes tie wrap shown below)</p> <p><b>⚠ ESD Sensitive.</b></p>	1	E850254




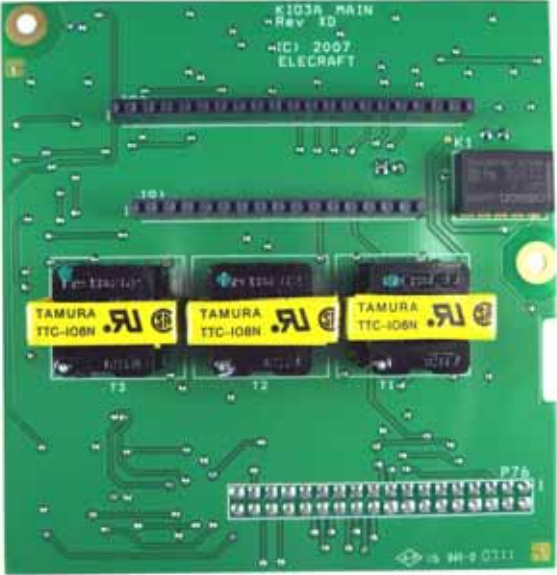

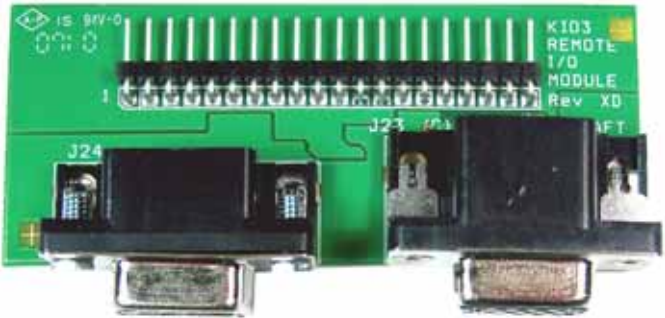
ILLUSTRATION	DESCRIPTION	QTY	ELECRAFT PART NO.
 <p>The image shows a green printed circuit board (PCB) for the KSYN3 Board. It features a large white circular component in the center, several yellow electrolytic capacitors, and various electronic components like resistors and integrated circuits. The board is populated with components and has a connector strip at the bottom. Text on the board includes 'KSYN3 REV. XD', '© 2007 ELECRAFT', and '4 0711'.</p>	<p>KSYN3 Board  <b>⚠ ESD Sensitive</b></p>	<p>1</p>	<p>E850260</p>
 <p>The image shows the KIO3 Main Board, a green PCB with several integrated circuits and connectors. Three prominent components are yellow Tamura TTC-108N capacitors. The board has multiple connector strips and various electronic components. Text on the board includes 'KIO3R MAIN', '-Rev 1D', '-IC3 2007', and 'ELECRAFT'.</p>	<p>KIO3 Main Board  <b>⚠ ESD Sensitive.</b></p>	<p>1</p>	<p>E850237</p>
 <p>The image shows the KIO3 Audio I/O Module, a green PCB with a connector strip at the top and several audio connectors at the bottom. The board is populated with components and has a connector strip at the top. Text on the board includes 'KIO3 AUDIO I/O MODULE', 'Rev 1D', '(C) 2007', and 'ELECRAFT'.</p>	<p>KIO3 Audio I/O Module  <b>⚠ ESD Sensitive.</b></p>	<p>1</p>	<p>E850236</p>

ILLUSTRATION	DESCRIPTION	QTY	ELECRAFT PART NO.
	<p>KIO3 Remote I/O Module</p> <p><b>⚠ ESD Sensitive.</b></p>	1	E850235

### E850262 Enclosure


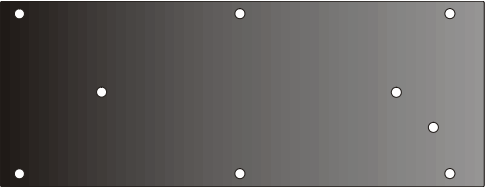
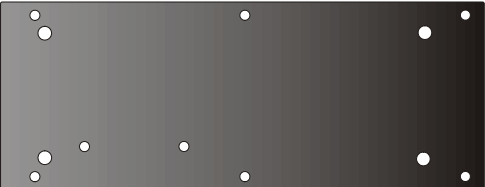
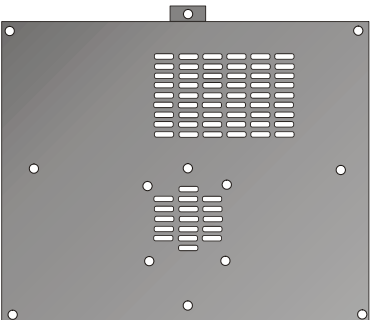

ILLUSTRATION	DESCRIPTION	QTY	ELECRAFT PART NO.
	Front Panel	1	E100209SS
	Left Side Panel	1	E100210
	Right Side Panel	1	E100211
	Top Cover	1	E100212


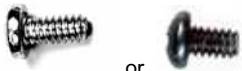

ILLUSTRATION	DESCRIPTION	QTY	ELECRAFT PART NO.
	Bottom Cover A	1	E100213
	Bottom Cover B	1	E100221
	Rear Panel	1	E100214SS
	Panel, Blank (KPA3 Fans) <b>Note:</b> This part is not supplied if you purchased the KPA 100 watt amplifier option with your K3 kit.	1	E850297
	Panel, Blank (KXV3 I/O) <b>Note:</b> This part is not supplied if you purchased the KXV3 I/O option with your K3 kit.	1	E850296
	Front Panel Shield	1	E100216
	Chassis Stiffener	1	E100222
	KIO3 Panel	1	E100218SS
	Loudspeaker with attached wire and connector	1	E850300
	Loudspeaker Shield	1	E980087

## E850239 K3 FP Encoder Assembly Bag

ILLUSTRATION	DESCRIPTION	QTY	ELECRAFT PART NO.
	Encoder Assembly	2	E850239


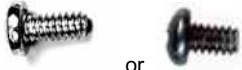

## E850249 I.F. Crystal Filter Bag (or Box)

NOTE: If the optional 8-pole 2.8K filter is purchased instead (see next item) this filter is not supplied.




ILLUSTRATION	DESCRIPTION	QTY	ELECRAFT PART NO.
	KFL3A-2.7K Filter <b>Note:</b> This filter is not supplied if you purchased the optional 8-pole 2.8 kHz filter with your K3 kit.	1	E850249
 or See Note in Description	Screw, 4-40, 1/4" (6.4 mm) Zinc, Pan Head  Note: May be supplied with a black, 4-40, 3/16" (4.8 mm), pan head screw instead	1	E700005
	Lock Washer, #4, Inside Tooth	1	E700010

## E850249 I.F. Crystal Filter Bag (or Box)



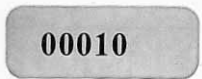
OPTION: Not supplied unless ordered. Otherwise the standard 5-pole filter (above) is supplied.

ILLUSTRATION	DESCRIPTION	QTY	ELECRAFT PART NO.
	KFL3A-2.8K Filter (optional, see above)	1	E850249
 or See Note in Description	Screw, 4-40, 1/4" (6.4 mm) Zinc, Pan Head  Note: May be supplied with a black, 4-40, 3/16" (4.8 mm), pan head screw instead.	1	E700005
	Lock Washer, #4, Inside Tooth	1	E700010





### KREF3 TCXO Module Bag

ILLUSTRATION	DESCRIPTION	QTY	ELECRAFT PART NO.
	KREF3 TCXO Module, 49.380 MHz, 5 ppm stability <b>Note:</b> This module is not supplied if you purchased the optional 1 ppm module with your kit.	1	E660033
	KREF3 TCXO Module, 49.380 MHz, (optional) 1 ppm stability (includes temperature compensation data sheet).	1	E660034
	Tie Wrap, KREF3 TCXO. Module	1	E980145

### E850307 K3 Front Panel Bezels and Serial Number Label

ILLUSTRATION	DESCRIPTION	QTY	ELECRAFT PART NO.
	Bezel (LCD cover), K3	1	E100195
	Trim Panel, K3 VFO	1	E100197
	Serial Number Label	1	E980137

### E850229 SO239 Ant Connector Assembly Bag

ILLUSTRATION	DESCRIPTION	QTY	ELECRAFT PART NO.
	SO239 (UHF) Female Panel Mount Connector with cable	1	E850229
	Screw, 4-40, 1/4" (6.4 mm) Black, Pan Head	2	E700009
	Lock Washer, #4, Inside Tooth	2	E700010
	Nut, 4-40	2	E700011

## E850263 K3 Miscellaneous Bag





















ILLUSTRATION	DESCRIPTION	QTY	ELECRAFT PART NO.
	TMP Cables	3	E100282
	SO239 (UHF) Female Panel Mount Connector with cable	1	TBD
	Battery BT1 (CR2032)	1	E850058
	Loudspeaker Grill Cloth	1	E850089
	#4 Fiber Washer	4	E700031
 <p>Front Feet with Stand</p>  <p>Rear Feet</p>	Bottom Feet with tilt stand	1	E980098
	SO239 Hole Cover	1	E980135
	BNC Hole Cover	2	E980136
	Thumbscrew, #6	1	E700070
	2D Fastener	10	E100078
<p>Typical Standoffs (May be round or hexagonal)</p> 	Standoff, 4-40, 1/4" (6.4 mm) long	6	E700026
	Standoff, 4-40, 3/8" (9.5 mm) long	2	E700153
	Standoff, 4-40, 1/2" (13 mm) long	3	E700061






ILLUSTRATION	DESCRIPTION	QTY	ELECRAFT PART NO.
	Screw, 4-40, 3/16" (4.8 mm) Black, Flat Head	26	E700025
	Screw, 4-40, 3/8" (9.5 mm) Black, Flat Head	6	E700131
	Screw, 4-40, 1/2" (13 mm) Black, Flat Head	1	E700132
<p data-bbox="284 577 527 604">Typical Pan Head Screws</p>  <p data-bbox="300 703 349 730">Zinc</p> <p data-bbox="446 703 495 730">Black</p>	Screw, 4-40, 3/16" (4.8 mm), Black, Pan Head	44	E700015
	Screw, 4-40, 1/4" (6.4 mm) Zinc, Pan Head	20	E700005
	Screw, 4-40, 1/4" (6.4 mm) Black, Pan Head	3	E700009
	Screw, 4-40, 7/16" (11 mm) Zinc, Pan Head	7	E700032
	Lock Washer #4, Split	36	E700004
	Lock Washer, #4, Inside Tooth	25	E700010
	Nut, 4-40	22	E700011
	Washer, Flat, #6	2	E700067
	Grommet Bumper, 7/16" Round (Side panel feet)	4	E980141
	Allen Wrench, 5/64" (in envelope)	1	E980004
	Allen Wrench, .050" (in envelope)	1	E980008

## E850241 Front Panel Hardware Bag

ILLUSTRATION	DESCRIPTION	QTY	ELECRAFT PART NO.
	Felt Washer	2	E700033
	Knurled Nut (Phones Jack)	1	E700138
Typical Standoffs 	Standoff, 2/56, 5/16" (7.9 mm) long	2	E700122
	Standoff, 4-40, 5/16" (7.9 mm) long	2	E700121
	Standoff, 4-40, 5/8" (15.9 mm) long	3	E700003
	Screw, 4-40, 3/16" (4.8 mm) Black, Flat Head	2	E700025
	Screw, 2-56, 5/32" (4.0 mm) Black, Pan head	4	E700149
	Screw, 2-56, 1/4" (6.4 mm) Black, Pan Head	4	E700124
	Screw, 4-40, 1/4" (6.4 mm) Zinc, Pan Head	6	E700005
	Lock Washer, #2, Split	2	E700123
	Lock Washer #4 Split	8	E700004
	Nut, 3/8" (9.5 mm) Hex	6	E700125
	Lock Washer, 3/8" (9.5 mm) Inside Tooth	5	E700150
	Washer, Flat, Phones Jack Spacer	1	E700145
 (Soft Foam Strips)	Front Panel Light Blocker (2 strips in envelope)	1	E850324




## E850238 KIO3A Hardware Bag

ILLUSTRATION	DESCRIPTION	QTY	ELECRAFT PART NO.
	Screw, 4-40, 1/4" (6.4 mm) Black, Pan Head	4	E700009
	Screw, 4-40, 1/4" (6.4 mm) Zinc, Pan Head	2	E700005
	Lock Washer, #4, Inside Tooth	4	E700010
	Jackscrew Nut, 4-40 Note: Two of the jackscrew nuts may be mounted on the DB-9 connector on the Remote I/O Board.	4	E700078
	Standoff, 4-40, 1-1/4" (31.8 mm) long	2	E700119





## E850308 K3 Knobs for Front Panel

ILLUSTRATION	DESCRIPTION	QTY	ELECRAFT PART NO.
	Knob, VFO B Tuning	1	E980090
	Knob, RIT/XIT	1	E980089
	Knob, Concentric Shaft, Large	2	E980092
	Knob, Concentric Shaft, Small	2	E980091
	Knob, Small Encoder Shaft	4	E980088

### E850306 K3 Knobs and Band for VFO A

ILLUSTRATION	DESCRIPTION	QTY	ELECRAFT PART NO.
	Knob, VFO A Tuning	1	E980093
	Finger Grip, Main VFO Tuning Knob	1	E980094

### E850316 Carrying Handle Bag

ILLUSTRATION	DESCRIPTION	QTY	ELECRAFT PART NO.
	Handle (strap, spring insert and two end caps)	1	E850316
	Screw, 6-32, 1/2" (13 mm), Black, Pan Head (in envelope)	2	E700042
	Lock Washer, #6, Split (in envelope)	2	E700041
	Nut, 6-32 (in envelope)	2	E700069

### E850301 Power Cable Kit

Bag with components and instructions sheet.